



Ventiladores helicentrífugos de tejado, de bajo consumo.

Modelos 500 y 800:

Cuerpo en inyección de plástico.

Base y sombrerete de chapa de acero, protegidos contra la corrosión con pintura epoxi-poliéster.

Modelos 1300 y 2000:

Cuerpo y base de chapa de acero y sombrerete de aluminio, todo ello protegido contra la corrosión con pintura epoxi-poliéster.

Incorporan malla antipájaros y embocadura en la base que facilita la conexión a conducto.

El conjunto motor-rodete se extrae fácilmente mediante 2 abrazaderas.

#### Motores

Modelos 500 y 800:

Motor brushless DC de corriente continua, de alto rendimiento y bajo consumo, alimentación 90/260V-50/60Hz, IP44, rodamientos a bolas, protección térmica.

Modelos 1300 y 2000:

Motor brushless EC de corriente continua, de alto rendimiento y bajo consumo, alimentación 230V±15% 50/60Hz, IP44, rodamientos a bolas, protección térmica.

Con potenciómetro incorporado para ajustar la velocidad del 10 al 100%, entrada analógica para controlar el ventilador con una señal de 0-10V.

#### Otros datos

Suministrados, en versión standard, como extractores. Girando 180° el conjunto motor-rodete, pueden trabajar como impulsores.

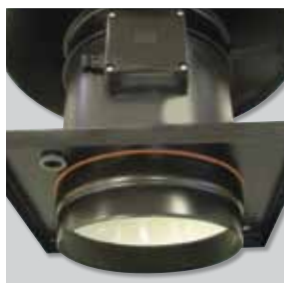

#### Embocadura que facilita el montaje

La embocadura de la base facilita la conexión a conducto.



#### Malla antipájaros



### CARACTERÍSTICAS TÉCNICAS

TH ECOWATT	Tensión de control (V)	Velocidad (r.p.m.)	Potencia absorbida máxima (W)	Intensidad absorbida máxima (A)	Caudal en descarga libre (m³/h)	Temperatura de trabajo (°C)	Nivel de presión sonora* a 4 m (dB(A))		Peso (kg)
							Aspiración	Descarga	
TH-500/150 ECOWATT	10	2670	45	0,4	470	-20/+60	46	52	3,8
	8	2275	31	0,2	410		44	48	
	6	1655	15	0,1	300		34	40	
	4	1135	7	0,1	200		29	30	
TH-500/160 ECOWATT	10	2695	48	0,4	490	-20/+60	47	51	3,8
	8	2280	32	0,2	430		43	47	
	6	1700	16	0,1	310		36	39	
	4	1130	8	0,1	210		27	30	
TH-800/200 ECOWATT	10	2490	98	0,6	750	-20/+60	47	51	5,6
	8	2190	68	0,4	650		43	47	
	6	1860	46	0,3	570		36	39	
	4	1520	28	0,2	470		27	30	
TH-1300/250 ECOWATT	10	2440	137	0,6	1.030	-20/+60	58	63	11,2
	8	2030	85	0,4	830		54	58	
	6	1620	51	0,3	670		50	51	
	4	1210	29	0,2	490		39	43	
TH-2000/315 ECOWATT	10	2460	230	1,0	1.530	-20/+60	60	65	17,2
	8	2000	131	0,6	1.230		54	58	
	6	1620	76	0,4	1.020		52	52	
	4	1215	39	0,2	740		43	45	

\* Nivel de presión sonora medido a 4 m, en los puntos 2, 5, 8 y 11 de las curvas características.

### DIMENSIONES (mm)

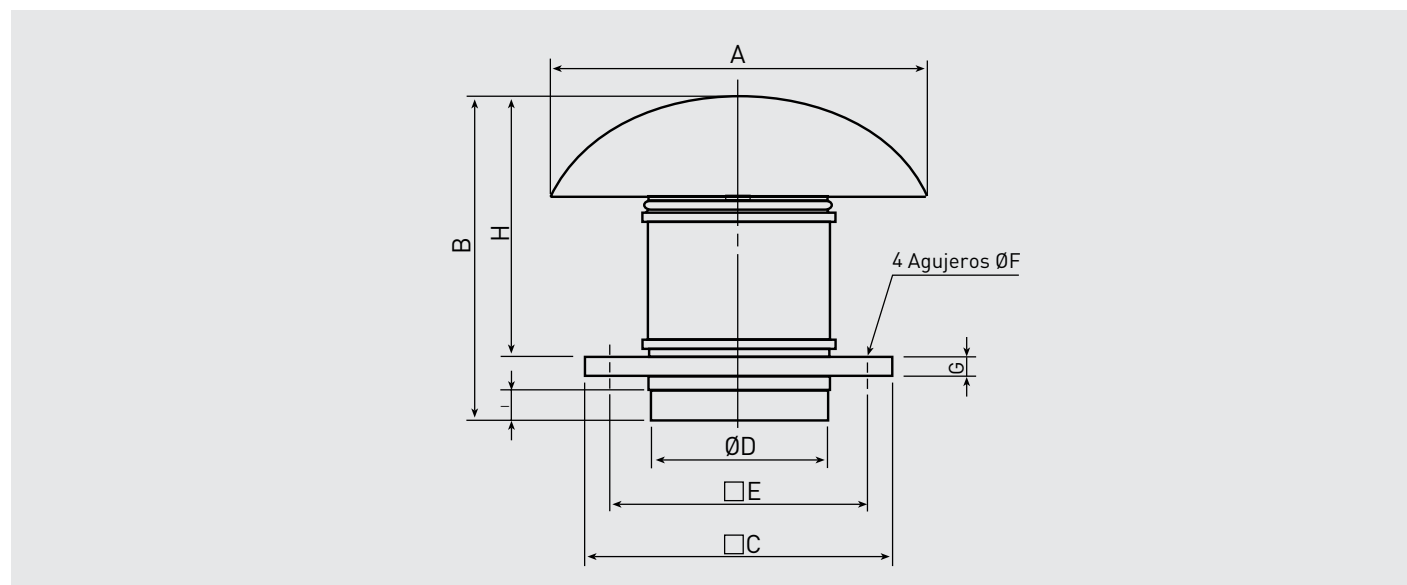

Modelo	A	B	C	D	E	F	G	H	I
TH-500/150 ECOWATT	400	349	300	150	245	10	20	274	33
TH-500/160 ECOWATT	400	339	300	160	245	10	20	274	33
TH-800/200 ECOWATT	400	371	300	198	245	10	20	306	36
TH-1300/250 ECOWATT	546	457	435	248	330	12	20	372	42
TH-2000/315 ECOWATT	735	544	560	312	450	12	20	450	50

### CURVAS CARACTERÍSTICAS

- $q_v$  = Caudal en  $m^3/h$  y  $m^3/s$ .
- $p_{sf}$  = Presión estática en mmcda y Pa.
- SFP: Factor específico de potencia en  $W/m^3/s$  (curvas azules).

- Aire seco normal a  $20^\circ C$  y 760 mmHg.
- Ensayos realizados de acuerdo a Norma ISO 5801 y AMCA 210-99.

TH-500/150 ECOWATT

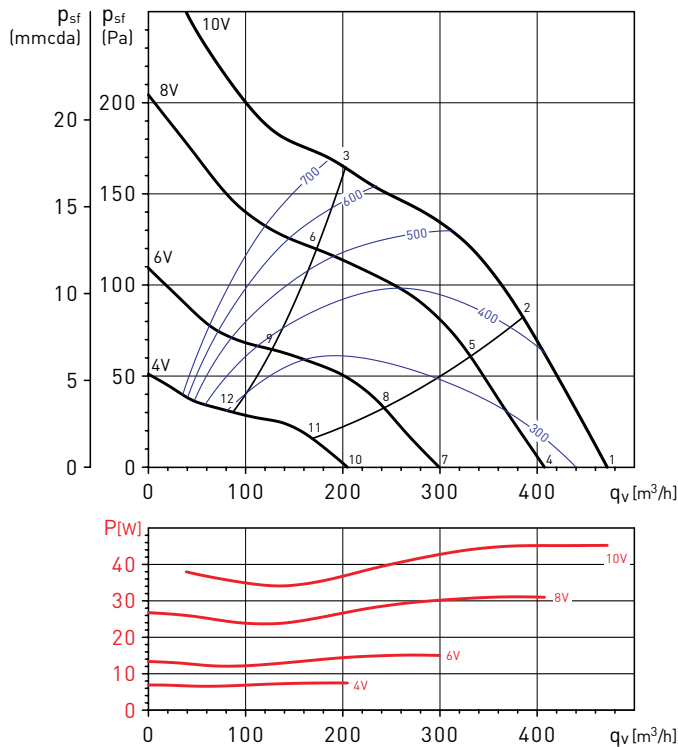

Espectros de potencia en dB(A)

Punto de trabajo		63	125	250	500	1.000	2.000	4.000	8.000	LwA
1	Aspiración	34	40	54	61	59	61	55	48	66
	Descarga	38	45	60	69	68	65	58	49	73
2	Aspiración	36	45	58	62	58	60	56	49	66
	Descarga	36	43	60	69	67	63	56	47	72
3	Aspiración	35	41	56	62	61	64	57	49	68
	Descarga	36	45	58	67	64	61	55	48	70
4	Aspiración	33	43	55	57	54	55	51	43	62
	Descarga	33	43	53	63	59	56	50	42	65
5	Aspiración	31	38	52	58	58	59	52	43	64
	Descarga	33	41	57	65	63	58	51	41	68
6	Aspiración	31	39	51	58	55	56	50	42	62
	Descarga	34	41	57	65	66	60	52	42	69
7	Aspiración	29	34	47	52	51	49	42	32	56
	Descarga	29	37	52	58	57	52	42	31	61
8	Aspiración	27	36	47	50	48	47	41	31	54
	Descarga	27	38	51	56	54	50	41	30	60
9	Aspiración	29	38	49	49	47	46	41	33	54
	Descarga	29	38	54	54	50	48	41	31	58
10	Aspiración	25	32	35	44	37	35	29	25	46
	Descarga	23	31	41	45	40	37	29	24	48
11	Aspiración	33	30	36	48	37	35	29	25	49
	Descarga	22	33	40	48	42	38	29	23	50
12	Aspiración	29	30	36	49	39	36	29	25	50
	Descarga	20	32	40	49	45	39	29	23	51

TH-500/160 ECOWATT

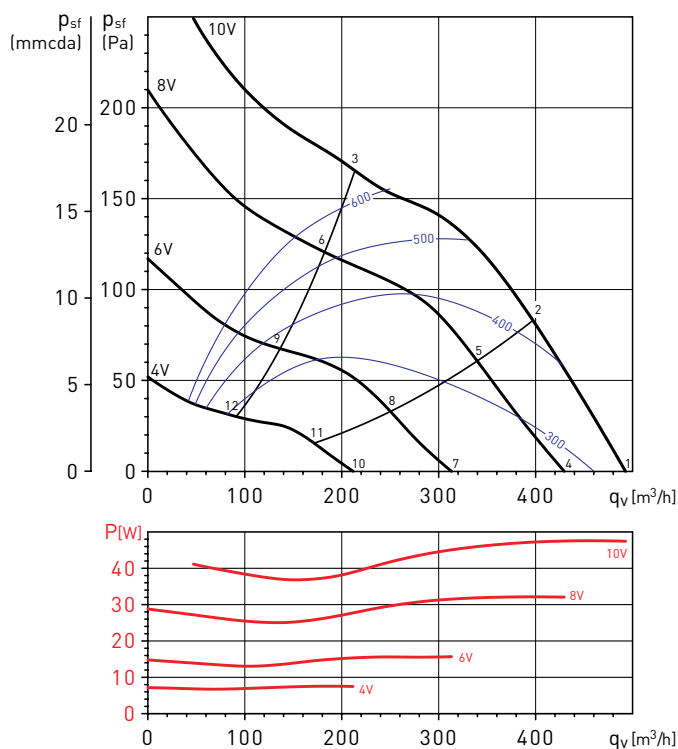

Espectros de potencia en dB(A)

Punto de trabajo		63	125	250	500	1.000	2.000	4.000	8.000	LwA
1	Aspiración	35	41	54	61	61	65	58	49	68
	Descarga	37	44	57	67	67	66	58	48	72
2	Aspiración	35	40	54	61	61	63	57	48	67
	Descarga	37	41	58	67	66	63	56	46	71
3	Aspiración	37	45	58	63	60	61	57	49	67
	Descarga	37	45	59	67	65	62	56	48	70
4	Aspiración	32	37	51	58	58	60	52	44	64
	Descarga	33	40	55	64	64	61	53	43	68
5	Aspiración	33	37	52	58	57	58	52	43	63
	Descarga	33	38	55	63	62	59	51	41	67
6	Aspiración	34	43	54	58	56	57	52	44	63
	Descarga	34	43	57	64	60	58	51	42	67
7	Aspiración	26	32	45	51	51	50	43	33	56
	Descarga	26	34	48	56	56	52	42	31	60
8	Aspiración	29	34	46	51	50	49	42	32	56
	Descarga	26	35	47	55	54	50	40	30	59
9	Aspiración	30	38	48	50	48	48	43	34	55
	Descarga	30	39	49	55	52	49	41	32	58
10	Aspiración	20	29	36	46	41	37	30	25	48
	Descarga	20	30	38	49	45	39	30	24	51
11	Aspiración	19	29	36	45	39	36	30	25	47
	Descarga	20	30	38	48	43	38	29	24	50
12	Aspiración	21	32	36	43	37	36	31	25	45
	Descarga	24	34	37	47	41	37	29	25	49

### CURVAS CARACTERÍSTICAS

- $q_v$  = Caudal en  $m^3/h$  y  $m^3/s$ .
- $p_{sf}$  = Presión estática en mmca y Pa.
- SFP: Factor específico de potencia en  $W/m^3/s$  (curvas azules).

- Aire seco normal a  $20^\circ C$  y 760 mmHg.
- Ensayos realizados de acuerdo a Norma ISO 5801 y AMCA 210-99.

TH-800/200 ECOWATT

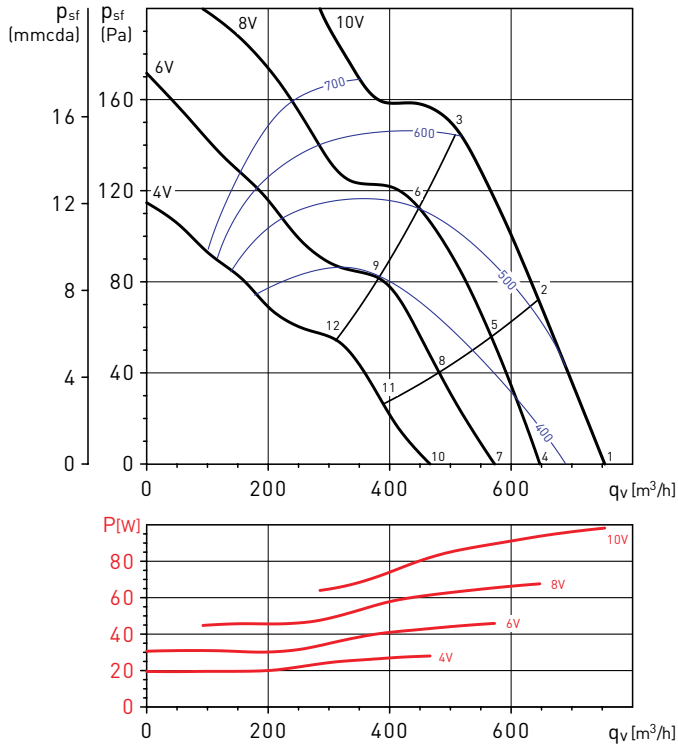

Espectros de potencia en dB(A)

Punto de trabajo		63	125	250	500	1.000	2.000	4.000	8.000	LwA
1	Aspiración	42	48	59	66	63	65	59	51	70
	Descarga	43	51	64	71	70	67	62	52	75
2	Aspiración	38	45	57	66	62	65	59	51	70
	Descarga	41	47	60	68	69	65	59	49	73
3	Aspiración	35	45	57	68	64	66	59	51	71
	Descarga	37	45	58	71	70	65	58	47	74
4	Aspiración	39	45	57	63	59	62	55	47	67
	Descarga	40	47	63	67	67	64	57	48	72
5	Aspiración	36	42	56	62	59	61	55	47	66
	Descarga	38	45	60	65	66	63	55	44	70
6	Aspiración	32	46	56	65	61	62	55	47	68
	Descarga	33	47	60	66	67	61	54	42	70
7	Aspiración	36	41	55	59	56	58	51	42	64
	Descarga	37	44	60	63	63	60	53	42	68
8	Aspiración	34	39	53	58	56	57	50	42	63
	Descarga	36	42	58	61	63	59	51	39	67
9	Aspiración	30	43	51	60	57	57	50	42	64
	Descarga	32	42	57	62	63	57	50	38	67
10	Aspiración	32	36	50	56	52	52	45	35	59
	Descarga	33	39	54	58	58	55	46	33	63
11	Aspiración	30	35	48	55	51	51	44	34	58
	Descarga	30	37	52	56	57	52	44	31	61
12	Aspiración	25	37	48	55	51	51	43	35	58
	Descarga	26	42	51	55	57	50	42	30	60

TH-1300/250 ECOWATT

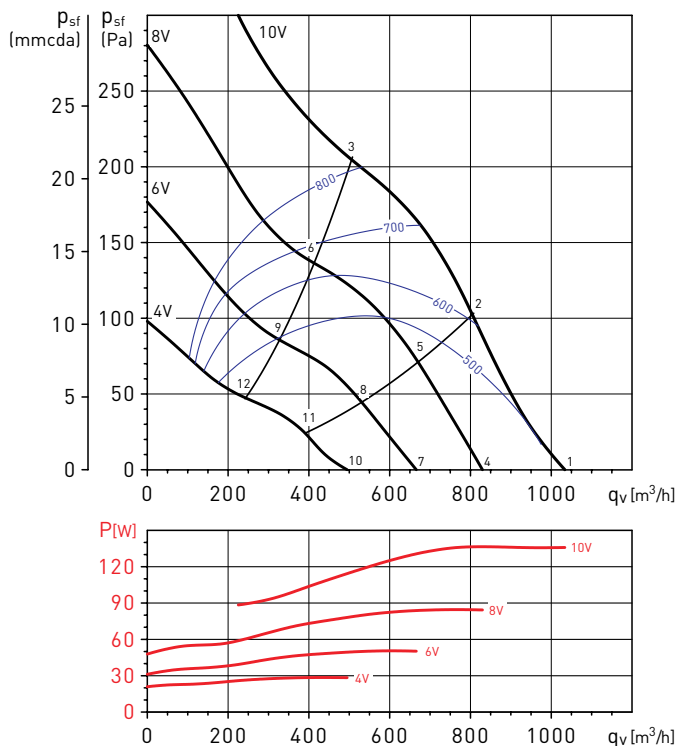

Espectros de potencia en dB(A)

Punto de trabajo		63	125	250	500	1.000	2.000	4.000	8.000	LwA
1	Aspiración	40	53	63	65	75	75	66	59	79
	Descarga	43	54	70	75	81	78	70	59	84
2	Aspiración	41	55	65	65	74	73	65	57	78
	Descarga	42	56	69	75	80	76	67	56	83
3	Aspiración	41	54	66	63	71	70	61	52	75
	Descarga	41	55	70	73	78	73	64	52	80
4	Aspiración	37	51	59	60	71	75	61	53	77
	Descarga	39	52	65	70	76	76	63	52	80
5	Aspiración	38	54	60	60	70	70	59	50	74
	Descarga	39	54	65	70	75	72	61	49	78
6	Aspiración	38	52	62	58	65	64	55	45	69
	Descarga	39	52	64	68	72	68	57	45	75
7	Aspiración	34	48	56	55	70	62	55	46	71
	Descarga	35	47	60	65	70	66	57	44	73
8	Aspiración	34	49	56	54	68	61	53	43	70
	Descarga	34	49	60	64	69	64	54	41	71
9	Aspiración	36	49	57	52	67	58	49	38	68
	Descarga	36	48	59	62	66	61	50	37	69
10	Aspiración	30	42	50	50	59	53	45	34	61
	Descarga	31	42	54	59	63	57	47	33	65
11	Aspiración	33	42	50	49	56	51	42	31	59
	Descarga	33	41	54	57	60	55	44	30	63
12	Aspiración	32	42	49	48	52	48	38	28	56
	Descarga	32	41	52	54	57	52	39	27	60

### CURVAS CARACTERÍSTICAS

- $q_v$  = Caudal en  $m^3/h$  y  $m^3/s$ .
- $p_{sf}$  = Presión estática en mmcd a y Pa.
- SFP: Factor específico de potencia en  $W/m^3/s$  (curvas azules).

- Aire seco normal a 20°C y 760 mmHg.
- Ensayos realizados de acuerdo a Norma ISO 5801 y AMCA 210-99.

TH-2000/315 ECOWATT

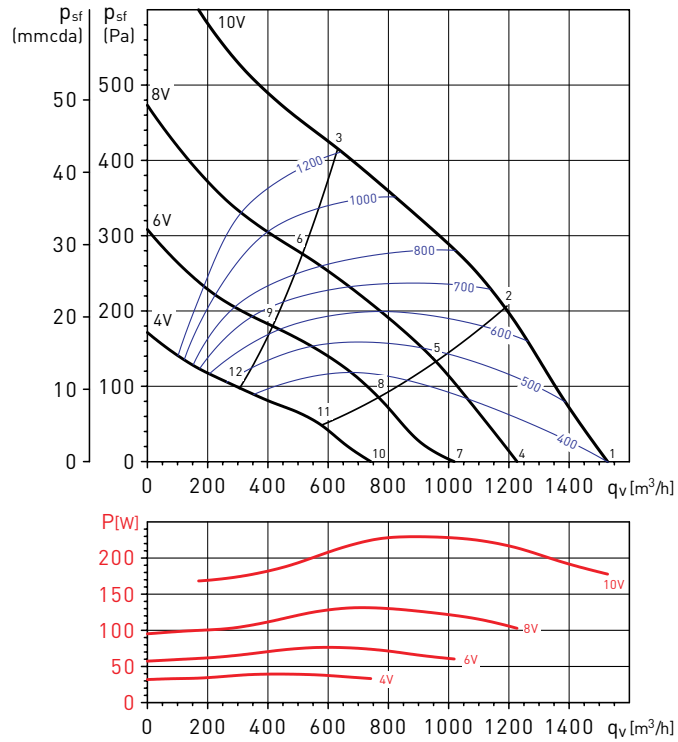

Espectros de potencia en dB(A)

Punto de trabajo		63	125	250	500	1.000	2.000	4.000	8.000	LwA
1	Aspiración	37	51	64	70	78	74	68	61	80
	Descarga	40	55	71	76	87	78	69	62	88
2	Aspiración	37	54	69	71	78	74	68	60	80
	Descarga	39	57	76	76	83	77	68	60	85
3	Aspiración	44	61	65	67	72	70	63	56	76
	Descarga	45	64	72	74	76	73	65	59	80
4	Aspiración	33	49	59	64	71	68	61	51	74
	Descarga	36	53	68	71	75	72	63	55	78
5	Aspiración	34	62	62	64	71	68	61	51	74
	Descarga	36	63	69	71	74	71	62	53	78
6	Aspiración	40	55	60	61	66	64	57	49	70
	Descarga	40	58	67	68	69	67	59	51	74
7	Aspiración	31	48	57	62	69	66	58	48	71
	Descarga	33	48	63	67	69	66	57	46	73
8	Aspiración	33	57	59	63	69	67	59	49	72
	Descarga	33	61	63	66	68	66	55	45	72
9	Aspiración	36	59	58	60	67	65	57	47	70
	Descarga	40	53	61	63	64	62	53	44	69
10	Aspiración	28	42	50	54	59	56	46	33	62
	Descarga	30	46	57	61	61	59	46	34	66
11	Aspiración	31	50	51	54	60	57	46	34	63
	Descarga	32	51	57	59	60	58	45	33	65
12	Aspiración	45	45	50	52	56	55	43	32	60
	Descarga	45	45	55	56	57	56	43	33	62

ACCESORIOS DE MONTAJE

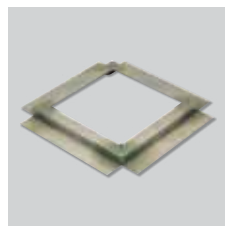

**JMS**  
Marcos soporte.

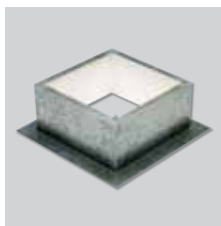

**JBS**  
Bases soporte.



**BI**  
Bases soporte para cubiertas inclinadas.

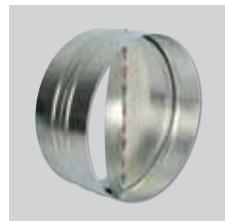

**CAR**  
Compuertas antirretorno.



**GSA-M0**  
Conductos flexibles de aluminio.



**SIL**  
Atenuadores acústicos.



**CX**  
Bridas regulables.

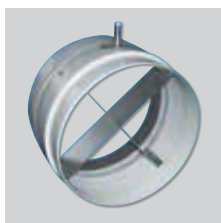

**MPC**  
Enderezadores de caudal.

ACCESORIOS ELÉCTRICOS



**CONTROL ECOWATT AC/DC**  
**CONTROL ECOWATT AC/4A**  
Elementos de control DCV (Demanda Controlada de Ventilación).



**REB-ECOWATT**  
Regulador de velocidad.



**SC02-A**  
Sensor de CO<sub>2</sub> y temperatura.  
**SC02-AD**  
Sensor de CO<sub>2</sub> y temperatura. Con display.  
**SCHAT-AD**  
Sensor de CO<sub>2</sub>, temperatura y humedad relativa. Con display.



**TDP-S/TDP-D/TDP-PI**  
Transmisores de presión.



**CPFL-S/CPFL-E**  
Detectores de presencia.

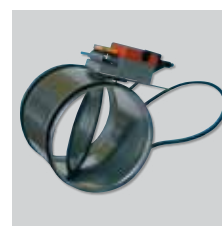

**REMP**  
Compuertas motorizadas.