



Ventiladores centrífugos in-line, de altas prestaciones, para conducto rectangular, de bajo perfil, fabricados en chapa de acero galvanizada, tapa para inspección y limpieza, caja de bornes remota, estanca IP55, ventilador centrífugo de álabes hacia atrás, fabricado en aluminio, equilibrado dinámicamente y motor de rotor exterior, Clase F, con rodamientos a bolas de engrase permanente y protector térmico incorporado.

Motores

Modelos monofásicos, IRB, 230V-50Hz, IP44* ó IP54, Clase F, regulables por variación de tensión.

*IP44: modelos 2-180, 2-200, 4-225 y 4-315 A.
Modelos trifásicos, IRT, 230/400V-50Hz, IP54, Clase F, regulables por variación de tensión o convertidor de frecuencia.

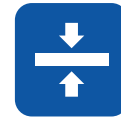

BAJO PERFIL

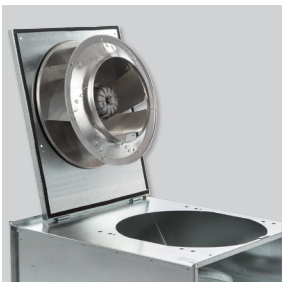

Tapa de inspección
Facilita el mantenimiento.



Instalación versátil
Pueden instalarse en cualquier posición.



Rodete de álabes hacia atrás
Evita que se adhiera la suciedad. Equilibrado dinámicamente.

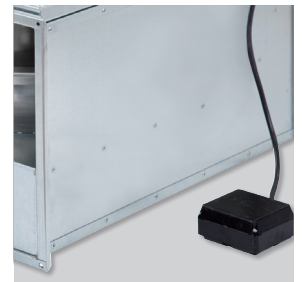

Caja de bornes remota, estanca IP55
Facilita la instalación y mantenimiento.

CARACTERÍSTICAS TÉCNICAS

Es imprescindible comprobar que las características eléctricas (voltaje, intensidad, frecuencia, etc.) del motor que aparecen en la placa del mismo son compatibles con las de la instalación.

Modelo	Dimensiones nominales de conducto (mm)	Velocidad (r.p.m.)	Potencia absorbida máxima (W)	Intensidad absorbida máxima (A)	Caudal máximo (m³/h)	Temperatura de trabajo (°C)	Nivel de presión sonora* (dB(A))			Peso (kg)	Regulador de tensión opcional**
							Aspiración	Radiado	Descarga		

MONOFÁSICOS

IRB/2-180	300x150	2690	63	0,3	510	-30/+70	56	42	59	10	RMB-1,5
IRB/2-200 A	400x200	2635	136	0,6	1.010	-30/+70	59	46	62	16	RMB-1,5
IRB/2-200 B	400x200	2610	204	0,9	1.350	-30/+70	61	48	65	16	RMB-1,5
IRB/4-225	500x250	1388	152	0,6	1.600	-40/+70	59	51	63	30	RMB-1,5
IRB/4-315 A	600x350	1397	278	1,2	2.620	-40/+70	59	51	63	37	RMB-1,5
IRB/4-315 B	600x350	1388	569	2,4	3.710	-40/+70	66	58	71	43	RMB-3,5
IRB/6-315	600x350	924	465	2,3	2.900	-40/+60	59	53	66	37	RMB-3,5
IRB/4-355	700x400	1402	845	3,6	5.600	-40/+50	66	55	72	56	RMB-8
IRB/6-355	700x400	909	572	2,4	4.730	-40/+70	61	53	66	56	RMB-3,5
IRB/6-400	800x500	935	840	3,7	7.230	-40/+70	64	55	70	66	RMB-8
IRB/6-450	1000x500	924	1416	6,1	8.930	-40/+70	67	61	74	97	RMB-8

* Nivel de presión sonora, medido en campo libre, a 1,5 metros de distancia, en el punto medio de la curva.

** Selección del convertidor de frecuencia: ver tabla de selección en apartado de accesorios eléctricos.

Modelo	Dimensiones nominales de conducto (mm)	Velocidad (r.p.m.)	Potencia absorbida máxima (W)	Intensidad absorbida máxima (A)		Caudal máximo (m³/h)	Temperatura de trabajo (°C)	Nivel de presión sonora* (dB(A))			Peso (kg)	Regulador de tensión opcional**
				230V	400V			Aspiración	Radiado	Descarga		

TRIFÁSICOS

IRT/4-315 A	600x350	1398	244	0,9	0,5	2.550	-40/+50	59	53	65	37	RMT-1,5
IRT/4-315 B	600x350	1415	568	2,1	1,2	3.850	-40/+70	68	59	72	43	RMT-1,5
IRT/4-355	700x400	1396	813	2,9	1,7	5.560	-40/+60	67	55	73	52	RMT-2,5
IRT/6-355	700x400	896	587	2,1	1,2	4.750	-40/+50	64	51	68	52	RMT-1,5
IRT/4-400 A	800x500	1431	1501	5,5	3,2	7.940	-40/+70	70	61	76	80	RMT-5
IRT/4-400 B	800x500	1393	2142	6,9	4,0	9.580	-40/+40	72	62	78	80	RMT-5
IRT/6-400	800x500	938	823	3,3	1,9	7.280	-40/+40	64	54	70	77	RMT-2,5
IRT/4-450	1000x500	1381	2379	7,4	4,3	10.720	-40/+40	74	67	80	96	RMT-5
IRT/6-450	1000x500	927	1418	5,9	3,4	9.090	-40/+60	68	60	75	97	RMT-5

* Nivel de presión sonora, medido en campo libre, a 1,5 metros de distancia, en el punto medio de la curva.

** Selección del convertidor de frecuencia: ver tabla de selección en apartado de accesorios eléctricos.

DIMENSIONES (mm)

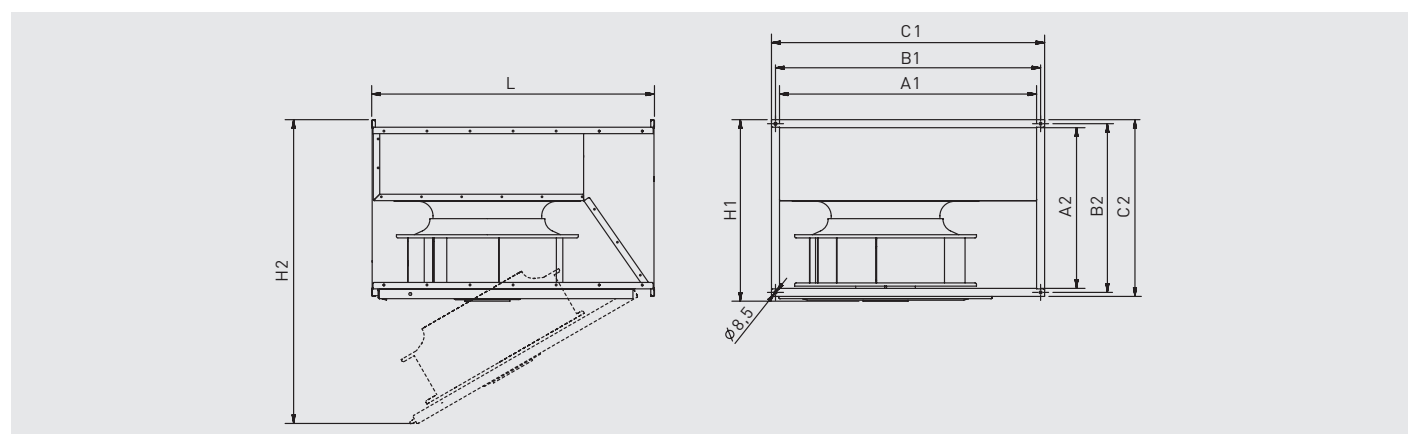

Modelo	A1	A2	B1	B2	C1	C2	H1	H2	L
180	300	150	320	170	340	190	200	480	375
200	400	200	420	220	440	240	250	650	500
225	500	250	520	270	540	290	300	730	530
315	600	350	620	370	640	390	405	1020	720
355	700	400	720	420	740	440	460	1135	790
400	800	500	820	520	845	545	565	1330	880
450	1000	500	1020	520	1045	545	565	1430	980

CURVAS CARACTERÍSTICAS

- q_v = Caudal en m^3/h y m^3/s .
- p_{sf} = Presión estática en mmcda y Pa.
- SFP: Factor específico de potencia en $W/m^3/h$ (curvas azules).
- Energía de entrada en W.
- Ensayos realizados de acuerdo a Norma ISO 5801 y AMCA 210-99.

IRB/2-180

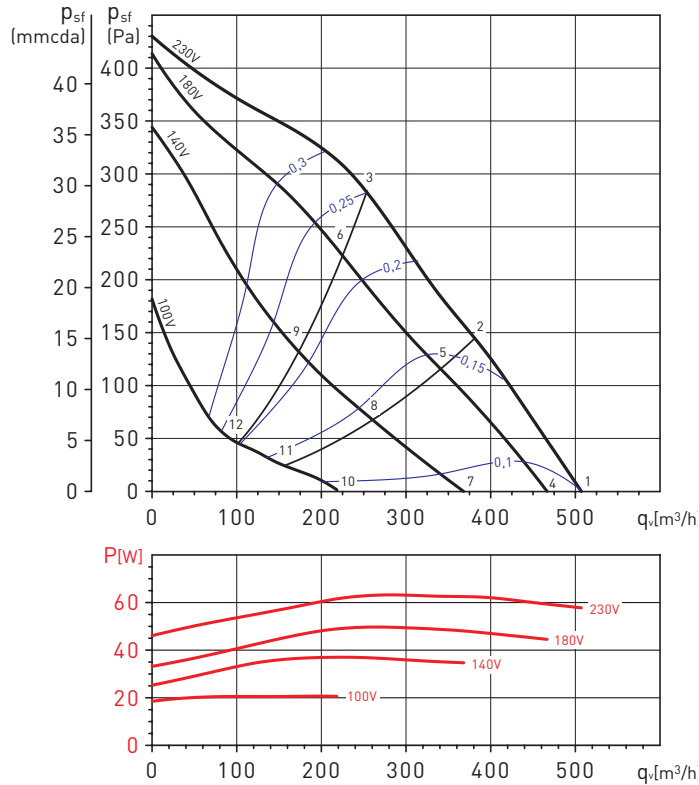

IRB/2-200A

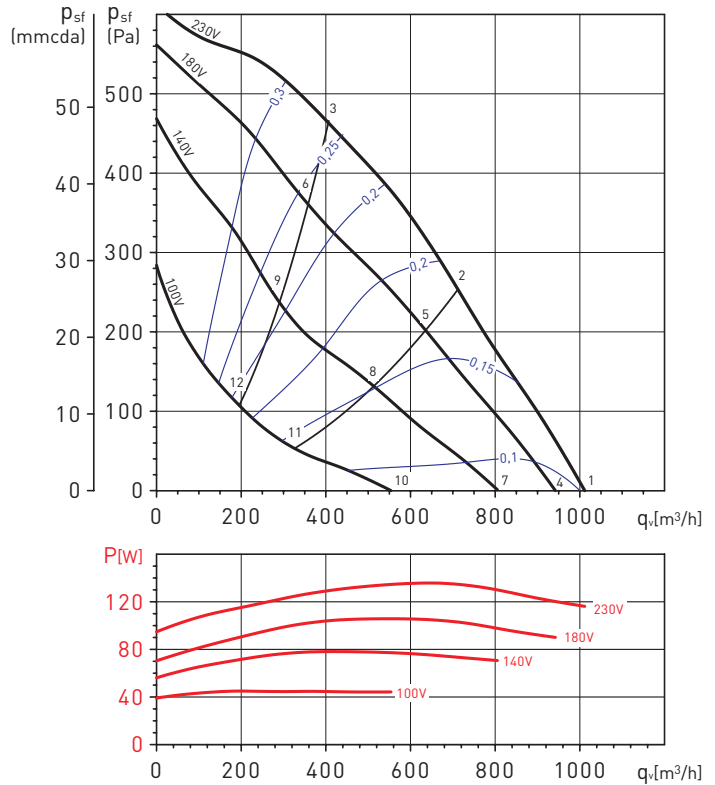

Espectros de nivel sonoro en dB(A)

Punto de trabajo	63	125	250	500	1.000	2.000	4.000	8.000	LwA	
1	Aspiración	36	42	69	62	67	68	63	57	74
	Descarga	37	40	64	66	72	73	67	59	77
	Radiado	31	33	55	49	53	53	53	49	61
2	Aspiración	31	39	63	57	64	65	60	50	70
	Descarga	33	37	62	63	68	69	63	52	73
	Radiado	26	30	50	45	49	50	50	43	56
3	Aspiración	31	41	62	57	63	62	55	46	68
	Descarga	32	39	60	61	66	66	58	48	70
	Radiado	26	31	49	44	48	48	45	38	54
4	Aspiración	30	41	67	60	65	66	61	53	72
	Descarga	30	39	66	64	70	71	65	55	75
	Radiado	26	31	55	47	50	53	52	46	59
5	Aspiración	27	38	59	55	61	62	56	46	67
	Descarga	27	35	58	60	65	66	59	47	70
	Radiado	23	28	47	43	47	48	47	39	54
6	Aspiración	29	40	59	55	60	59	52	42	65
	Descarga	27	39	57	58	63	63	54	43	67
	Radiado	25	29	47	43	45	45	42	35	52
7	Aspiración	27	39	65	56	60	62	56	44	68
	Descarga	26	36	60	59	65	66	59	46	70
	Radiado	19	29	55	44	46	49	48	40	58
8	Aspiración	24	35	52	51	54	55	48	34	60
	Descarga	24	31	51	54	58	59	50	35	63
	Radiado	17	25	43	40	41	43	40	29	48
9	Aspiración	24	40	52	51	53	52	43	32	58
	Descarga	23	37	51	53	56	56	45	33	60
	Radiado	17	30	42	39	40	40	35	27	47
10	Aspiración	24	37	43	45	49	51	37	26	54
	Descarga	20	35	43	48	53	54	40	27	58
	Radiado	23	31	35	35	38	41	33	24	45
11	Aspiración	21	32	39	42	43	42	28	24	48
	Descarga	32	29	40	43	47	45	29	24	50
	Radiado	20	26	31	31	33	32	23	22	38
12	Aspiración	23	31	39	41	41	36	26	23	46
	Descarga	23	27	39	41	44	40	27	23	47
	Radiado	22	25	31	30	30	27	22	21	36

Espectros de nivel sonoro en dB(A)

Punto de trabajo	63	125	250	500	1.000	2.000	4.000	8.000	LwA	
1	Aspiración	39	56	77	71	73	69	65	60	79
	Descarga	38	56	73	74	77	77	71	67	82
	Radiado	38	44	64	64	56	54	50	47	68
2	Aspiración	34	51	69	63	68	63	60	52	73
	Descarga	34	52	65	68	70	71	64	58	76
	Radiado	33	39	56	56	51	48	45	40	60
3	Aspiración	33	52	65	59	65	60	57	50	69
	Descarga	36	54	62	66	68	68	60	53	73
	Radiado	32	40	52	52	48	45	42	37	57
4	Aspiración	37	55	77	68	71	67	63	58	79
	Descarga	36	54	72	72	75	76	69	65	80
	Radiado	35	43	64	61	54	52	48	46	66
5	Aspiración	32	50	66	60	64	60	58	49	70
	Descarga	32	50	63	66	68	69	62	56	74
	Radiado	30	37	53	52	48	46	42	37	57
6	Aspiración	31	50	63	57	62	57	54	46	67
	Descarga	32	51	60	64	65	65	57	50	70
	Radiado	29	38	50	50	45	43	39	34	55
7	Aspiración	34	52	72	62	66	62	60	52	74
	Descarga	34	51	66	69	71	71	66	60	76
	Radiado	31	39	59	56	50	49	46	42	62
8	Aspiración	28	45	59	55	58	54	53	36	64
	Descarga	28	45	61	61	62	63	57	43	68
	Radiado	25	32	47	49	42	41	38	25	52
9	Aspiración	29	46	56	54	57	52	48	37	61
	Descarga	38	46	56	58	59	59	50	40	65
	Radiado	26	33	43	48	41	38	34	26	50
10	Aspiración	34	56	56	53	57	54	54	32	63
	Descarga	32	57	55	58	60	62	58	39	67
	Radiado	26	49	47	48	43	44	42	24	54
11	Aspiración	36	44	48	46	48	50	45	24	55
	Descarga	24	44	46	50	52	55	45	26	58
	Radiado	28	38	40	41	35	40	33	17	46
12	Aspiración	28	40	48	44	47	41	35	24	52
	Descarga	25	41	43	47	49	47	36	26	53
	Radiado	20	33	39	39	33	30	23	17	43

CURVAS CARACTERÍSTICAS

- q_v = Caudal en m^3/h y m^3/s .
- p_{sf} = Presión estática en mmcd a y Pa.
- SFP: Factor específico de potencia en $W/m^3/h$ (curvas azules).
- Energía de entrada en W.
- Ensayos realizados de acuerdo a Norma ISO 5801 y AMCA 210-99.

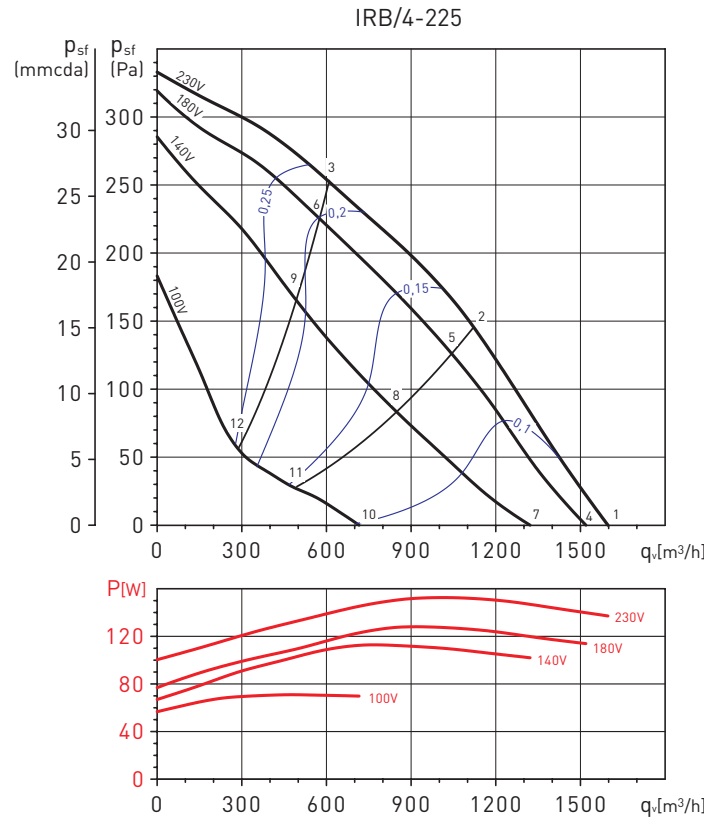
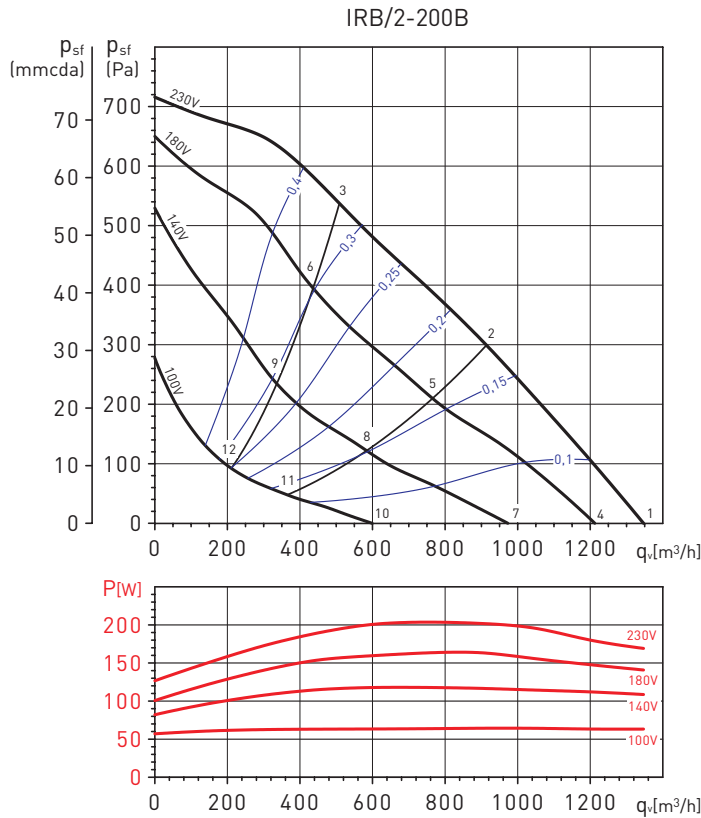

Espectros de nivel sonoro en dB(A)

Punto de trabajo	63	125	250	500	1.000	2.000	4.000	8.000	LwA	
1	Aspiración	42	57	84	73	77	71	68	63	85
	Descarga	43	59	79	77	79	80	73	69	85
	Radiado	42	49	72	62	60	57	52	52	73
2	Aspiración	36	54	71	65	71	65	62	57	75
	Descarga	37	56	71	71	74	74	66	61	79
	Radiado	37	45	59	55	55	51	46	45	62
3	Aspiración	36	55	70	63	70	64	60	53	74
	Descarga	38	57	66	70	72	72	64	57	77
	Radiado	37	46	58	52	54	50	44	42	61
4	Aspiración	41	56	80	69	75	69	65	62	82
	Descarga	40	56	74	74	77	77	70	66	82
	Radiado	41	47	69	59	58	54	50	51	70
5	Aspiración	34	54	69	62	68	62	58	54	73
	Descarga	34	51	66	68	70	71	63	57	75
	Radiado	35	45	58	51	52	48	43	43	60
6	Aspiración	33	56	65	59	66	60	55	49	70
	Descarga	34	54	65	67	68	68	59	52	73
	Radiado	34	47	53	49	50	46	40	38	57
7	Aspiración	36	53	72	63	69	63	59	57	75
	Descarga	36	54	66	68	71	71	65	61	76
	Radiado	36	45	61	54	53	49	45	47	63
8	Aspiración	28	53	60	56	61	54	53	38	65
	Descarga	28	55	66	61	63	63	57	42	70
	Radiado	28	45	49	47	45	41	39	27	53
9	Aspiración	31	47	56	57	59	53	47	37	63
	Descarga	32	52	58	60	61	60	49	39	66
	Radiado	31	40	45	47	44	40	33	27	51
10	Aspiración	29	50	54	52	57	53	53	30	62
	Descarga	27	51	52	56	59	60	55	35	65
	Radiado	28	47	44	43	43	41	41	23	51
11	Aspiración	24	43	47	45	50	47	37	24	54
	Descarga	22	41	45	49	51	54	40	26	57
	Radiado	24	40	37	35	35	35	25	16	44
12	Aspiración	26	42	46	44	48	40	32	24	52
	Descarga	28	42	45	48	49	46	34	25	54
	Radiado	25	39	36	35	33	28	20	16	42

Espectros de nivel sonoro en dB(A)

Punto de trabajo	63	125	250	500	1.000	2.000	4.000	8.000	LwA	
1	Aspiración	45	67	68	72	71	66	61	52	77
	Descarga	45	74	71	75	77	73	66	57	82
	Radiado	46	64	61	61	61	54	48	35	68
2	Aspiración	41	65	64	68	66	62	54	47	73
	Descarga	42	69	67	71	72	69	60	51	77
	Radiado	42	61	57	57	56	49	41	29	65
3	Aspiración	40	59	61	64	63	59	54	50	69
	Descarga	41	64	63	66	68	64	56	47	72
	Radiado	41	55	54	53	53	47	41	33	60
4	Aspiración	44	68	67	71	69	65	60	49	76
	Descarga	44	77	70	74	75	72	65	54	81
	Radiado	45	64	60	60	59	52	47	32	67
5	Aspiración	40	64	62	66	64	60	52	44	71
	Descarga	40	70	64	69	70	66	57	48	76
	Radiado	41	59	56	55	54	48	40	27	63
6	Aspiración	39	59	60	62	62	58	52	48	68
	Descarga	40	64	61	65	66	62	54	45	71
	Radiado	40	54	53	51	51	46	39	31	59
7	Aspiración	41	60	62	66	64	60	55	42	70
	Descarga	41	64	64	69	71	67	62	48	75
	Radiado	42	54	56	55	54	48	43	25	61
8	Aspiración	37	55	57	61	59	54	46	36	65
	Descarga	37	58	59	63	64	60	51	40	68
	Radiado	38	49	50	50	48	42	33	19	56
9	Aspiración	37	53	56	59	58	53	47	44	63
	Descarga	38	56	57	61	62	58	49	40	66
	Radiado	38	47	50	48	47	41	35	26	54
10	Aspiración	37	49	48	51	51	51	32	26	57
	Descarga	34	50	48	53	55	54	35	26	60
	Radiado	38	46	42	42	40	38	19	9	50
11	Aspiración	29	43	44	47	47	40	27	24	52
	Descarga	28	46	44	48	48	42	30	24	53
	Radiado	31	40	37	38	36	27	14	7	44
12	Aspiración	28	47	43	46	44	37	29	25	52
	Descarga	30	48	44	49	48	42	36	32	54
	Radiado	30	44	37	37	33	24	17	8	46

CURVAS CARACTERÍSTICAS

- q_v = Caudal en m^3/h y m^3/s .
- p_{sf} = Presión estática en mmcdca y Pa.
- SFP: Factor específico de potencia en $W/m^3/h$ (curvas azules).
- Energía de entrada en W.
- Ensayos realizados de acuerdo a Norma ISO 5801 y AMCA 210-99.

IRB/4-315 A

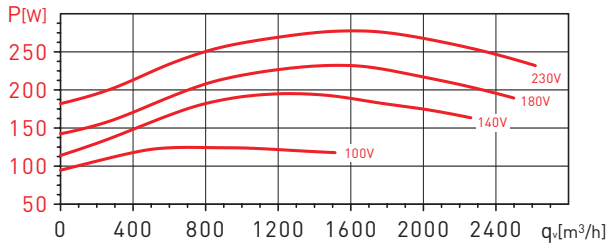
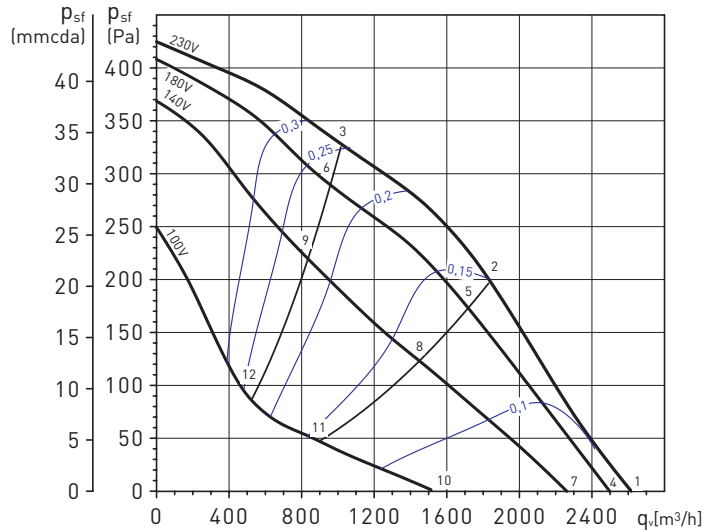

IRB/4-315 B

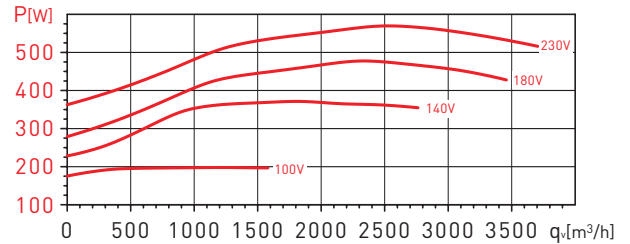
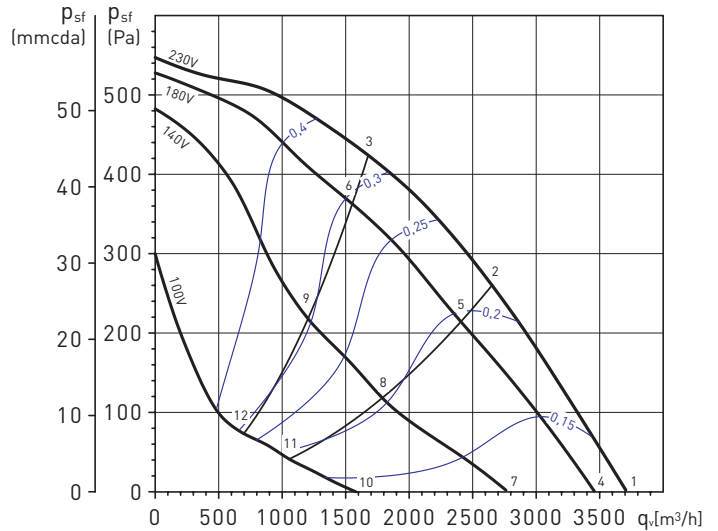

Espectros de nivel sonoro en dB(A)

Punto de trabajo	63	125	250	500	1.000	2.000	4.000	8.000	LwA	
1	Aspiración	46	71	67	73	71	68	60	60	78
	Descarga	47	71	73	76	78	74	65	64	82
	Radiado	42	64	61	60	64	58	52	56	69
2	Aspiración	43	67	63	68	67	62	55	52	73
	Descarga	45	68	69	71	73	68	60	54	77
	Radiado	40	61	57	55	59	52	47	48	65
3	Aspiración	46	64	61	65	66	60	53	47	71
	Descarga	45	64	66	68	70	64	57	50	74
	Radiado	42	58	55	52	58	50	46	43	63
4	Aspiración	45	71	66	71	70	67	58	59	77
	Descarga	47	70	73	75	77	73	64	61	81
	Radiado	42	63	59	58	61	56	51	55	67
5	Aspiración	42	66	61	65	64	60	53	51	71
	Descarga	43	69	68	69	71	65	59	50	76
	Radiado	39	57	54	52	55	50	45	47	62
6	Aspiración	44	64	60	64	62	59	52	45	69
	Descarga	44	63	64	66	68	62	55	48	72
	Radiado	41	56	53	50	53	48	44	41	60
7	Aspiración	44	71	63	68	66	63	55	57	75
	Descarga	45	72	69	72	74	70	62	55	79
	Radiado	41	64	56	54	58	53	48	53	66
8	Aspiración	41	60	56	63	59	54	49	41	67
	Descarga	40	59	61	64	65	58	53	41	69
	Radiado	37	52	50	49	50	44	42	37	57
9	Aspiración	43	59	57	61	59	55	48	40	66
	Descarga	44	59	60	63	64	59	51	43	69
	Radiado	40	51	50	47	50	45	41	36	57
10	Aspiración	44	54	52	56	54	50	52	31	61
	Descarga	43	53	58	60	63	56	52	37	66
	Radiado	42	49	46	45	46	41	46	28	54
11	Aspiración	35	47	46	47	44	40	31	24	53
	Descarga	39	45	48	49	49	43	33	25	55
	Radiado	33	42	40	36	35	31	26	21	46
12	Aspiración	37	50	48	50	47	42	32	25	55
	Descarga	40	47	48	54	52	44	35	26	57
	Radiado	35	45	42	39	39	32	26	22	48

Espectros de nivel sonoro en dB(A)

Punto de trabajo	63	125	250	500	1.000	2.000	4.000	8.000	LwA	
1	Aspiración	55	75	76	80	75	73	64	60	83
	Descarga	58	77	81	84	85	81	73	66	90
	Radiado	54	72	67	69	63	59	54	52	75
2	Aspiración	51	72	73	76	71	69	60	52	80
	Descarga	58	73	77	80	81	76	68	60	85
	Radiado	50	69	64	66	59	55	50	44	72
3	Aspiración	53	70	69	72	67	66	57	49	77
	Descarga	54	71	74	76	77	72	64	55	81
	Radiado	52	68	60	62	55	52	48	41	69
4	Aspiración	54	72	74	78	73	71	62	57	82
	Descarga	56	77	79	82	83	78	70	64	87
	Radiado	53	68	64	70	61	57	50	47	73
5	Aspiración	50	70	69	74	68	66	56	48	77
	Descarga	55	71	74	77	77	72	64	56	82
	Radiado	49	66	59	65	55	52	44	38	69
6	Aspiración	51	68	67	73	66	64	55	47	76
	Descarga	53	70	71	75	74	69	62	53	80
	Radiado	51	64	57	64	54	50	43	37	68
7	Aspiración	50	69	67	71	65	63	56	43	75
	Descarga	51	72	71	75	75	70	64	52	80
	Radiado	50	64	57	64	53	47	43	31	67
8	Aspiración	46	61	62	70	58	55	48	45	72
	Descarga	48	61	64	70	67	61	53	44	73
	Radiado	46	56	51	63	47	39	34	33	64
9	Aspiración	49	61	62	69	61	58	50	43	71
	Descarga	50	65	65	70	69	64	57	49	74
	Radiado	48	56	51	61	49	42	37	31	63
10	Aspiración	42	52	56	64	51	51	35	25	65
	Descarga	44	54	58	64	60	57	44	32	67
	Radiado	42	47	46	57	43	37	24	15	58
11	Aspiración	37	48	52	65	46	41	32	24	65
	Descarga	38	51	54	62	53	47	37	26	63
	Radiado	37	43	43	58	38	26	21	13	58
12	Aspiración	36	48	52	65	47	40	33	24	65
	Descarga	39	50	54	63	53	45	36	26	64
	Radiado	37	42	43	58	39	25	21	13	59

CURVAS CARACTERÍSTICAS

- q_v = Caudal en m^3/h y m^3/s .
- p_{sf} = Presión estática en mmcda y Pa.
- SFP: Factor específico de potencia en $W/m^3/h$ (curvas azules).
- Energía de entrada en W.
- Ensayos realizados de acuerdo a Norma ISO 5801 y AMCA 210-99.

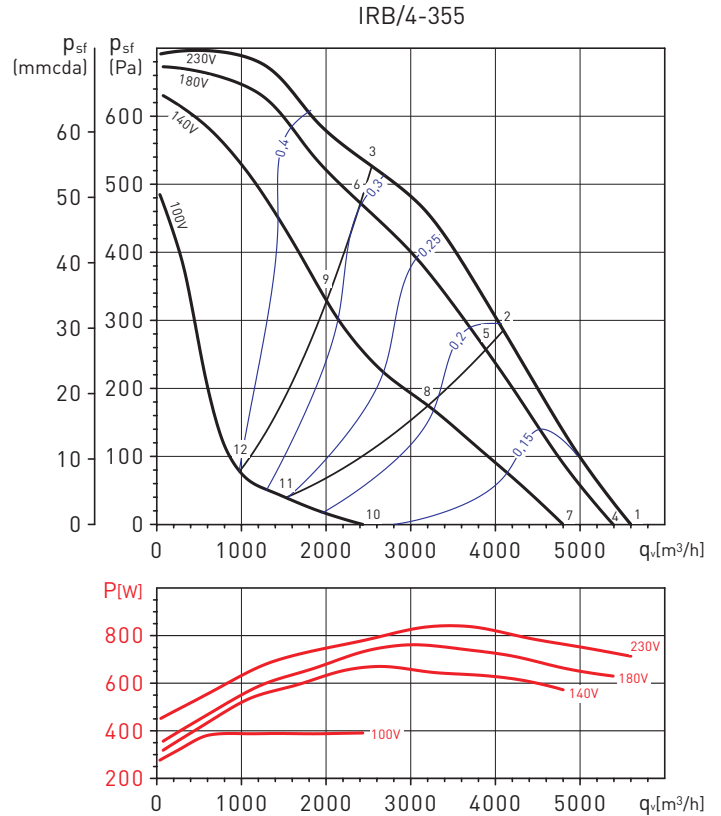
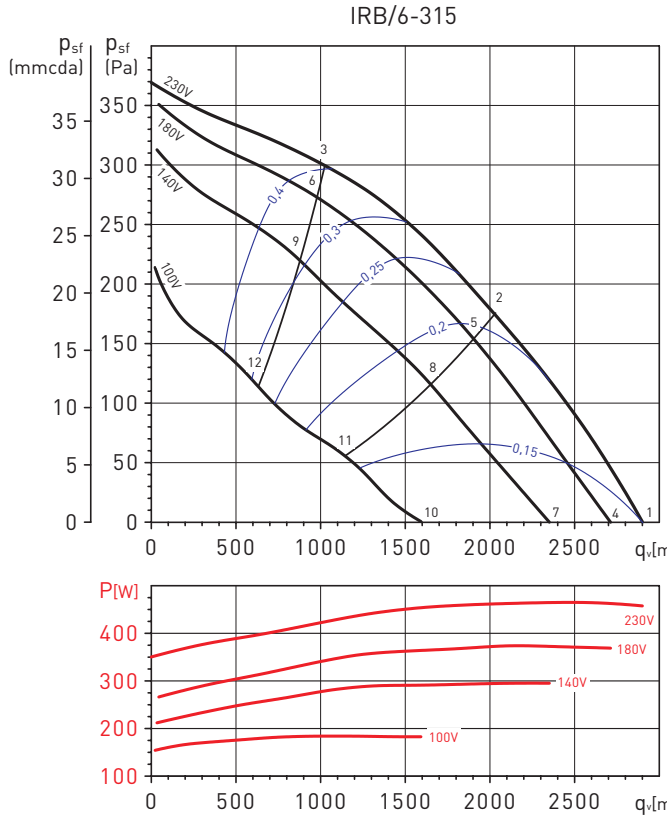

Espectros de nivel sonoro en dB(A)

Punto de trabajo	63	125	250	500	1.000	2.000	4.000	8.000	LwA	
1	Aspiración	59	70	68	74	71	65	58	51	78
	Descarga	58	74	75	79	79	72	65	57	84
	Radiado	61	65	65	67	61	54	45	38	71
2	Aspiración	56	65	64	70	66	61	55	48	73
	Descarga	56	70	71	76	74	68	62	55	80
	Radiado	58	61	61	63	57	50	42	36	67
3	Aspiración	57	66	64	70	68	64	58	51	74
	Descarga	56	70	70	75	75	70	63	56	80
	Radiado	59	61	61	63	58	53	44	39	68
4	Aspiración	58	68	66	73	69	62	57	49	76
	Descarga	57	72	73	77	76	70	63	55	82
	Radiado	61	64	63	65	59	52	43	36	70
5	Aspiración	54	65	63	69	64	59	53	46	72
	Descarga	55	68	69	74	72	66	60	53	78
	Radiado	57	61	60	61	54	48	40	34	67
6	Aspiración	57	65	63	69	66	62	56	50	73
	Descarga	56	70	69	74	73	68	61	54	79
	Radiado	59	61	60	62	56	51	43	37	67
7	Aspiración	59	63	62	69	64	58	53	43	72
	Descarga	58	67	68	73	71	64	58	49	77
	Radiado	62	60	59	62	54	47	39	31	67
8	Aspiración	55	59	59	66	60	55	49	42	68
	Descarga	54	62	65	69	67	62	55	48	73
	Radiado	58	56	56	59	51	44	36	30	64
9	Aspiración	57	65	60	67	63	59	53	47	71
	Descarga	57	68	66	71	70	65	58	51	76
	Radiado	59	63	57	60	53	48	40	34	66
10	Aspiración	47	55	51	59	52	48	39	32	62
	Descarga	47	58	57	63	59	54	45	37	66
	Radiado	48	53	49	54	43	38	26	22	58
11	Aspiración	44	53	49	58	50	44	37	31	60
	Descarga	45	56	55	61	56	51	43	35	64
	Radiado	45	51	47	52	41	34	25	21	56
12	Aspiración	48	53	51	60	54	49	43	35	62
	Descarga	51	57	57	63	60	55	48	39	66
	Radiado	49	52	49	54	45	39	30	25	58

Espectros de nivel sonoro en dB(A)

Punto de trabajo	63	125	250	500	1.000	2.000	4.000	8.000	LwA	
1	Aspiración	58	78	76	81	77	77	70	68	85
	Descarga	59	77	82	86	88	82	76	71	92
	Radiado	56	68	67	66	66	61	53	51	74
2	Aspiración	53	74	72	76	72	71	63	56	80
	Descarga	56	74	78	81	83	76	68	61	86
	Radiado	50	65	63	61	61	55	46	40	69
3	Aspiración	51	71	67	71	69	68	62	56	77
	Descarga	55	70	74	76	77	70	64	57	82
	Radiado	48	62	58	57	58	52	45	40	65
4	Aspiración	57	77	74	79	76	76	69	66	84
	Descarga	59	76	81	84	87	81	74	69	90
	Radiado	55	67	65	65	65	59	52	49	72
5	Aspiración	51	73	69	74	70	69	61	54	78
	Descarga	55	72	76	79	81	74	66	59	84
	Radiado	49	63	60	59	59	52	44	37	67
6	Aspiración	50	69	65	70	68	67	60	54	75
	Descarga	54	70	73	75	76	69	62	55	80
	Radiado	47	59	57	55	56	50	43	38	64
7	Aspiración	54	71	69	74	71	70	65	56	78
	Descarga	57	73	77	80	82	77	71	63	86
	Radiado	52	64	61	59	58	53	48	40	68
8	Aspiración	46	66	60	65	62	60	52	45	70
	Descarga	52	66	69	73	72	65	59	51	77
	Radiado	44	59	52	50	50	43	35	28	61
9	Aspiración	50	64	61	65	62	61	54	48	70
	Descarga	52	66	68	69	70	63	57	50	75
	Radiado	47	58	52	50	50	44	37	32	60
10	Aspiración	44	53	52	56	52	54	39	32	61
	Descarga	46	53	56	59	61	58	44	35	66
	Radiado	42	46	44	42	40	37	23	17	51
11	Aspiración	36	49	47	57	44	41	33	30	58
	Descarga	38	49	49	54	51	47	37	31	58
	Radiado	34	42	39	43	32	25	17	15	47
12	Aspiración	37	48	45	52	43	43	33	30	55
	Descarga	38	48	48	54	49	48	37	31	57
	Radiado	34	41	37	38	31	26	17	15	45

CURVAS CARACTERÍSTICAS

- q_v = Caudal en m^3/h y m^3/s .
- p_{sf} = Presión estática en mmcda y Pa.
- SFP: Factor específico de potencia en $W/m^3/h$ (curvas azules).
- Energía de entrada en W.
- Ensayos realizados de acuerdo a Norma ISO 5801 y AMCA 210-99.

IRB/6-355

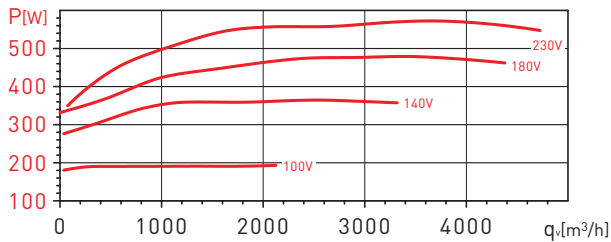
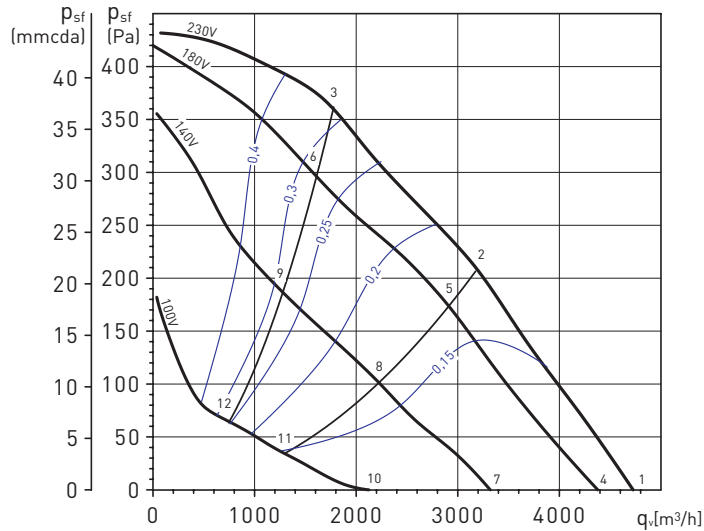

IRB/6-400

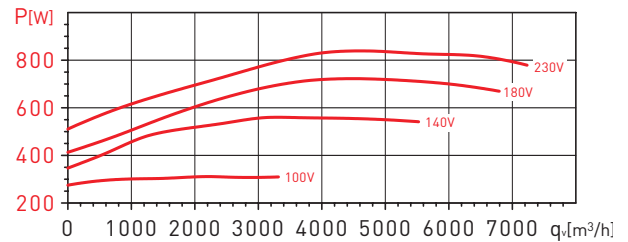
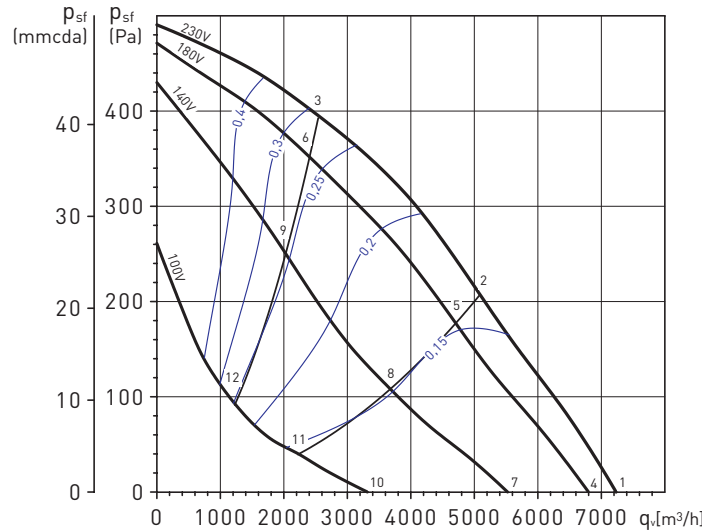

Espectros de nivel sonoro en dB(A)

Punto de trabajo	63	125	250	500	1.000	2.000	4.000	8.000	LwA
1 Aspiración	59	72	74	77	72	69	61	53	81
1 Descarga	58	75	78	82	82	75	67	59	86
1 Radiado	59	66	63	66	64	63	55	46	72
2 Aspiración	55	68	68	70	66	63	57	50	75
2 Descarga	56	71	72	76	75	68	61	55	80
2 Radiado	55	62	57	60	58	57	51	43	67
3 Aspiración	56	74	69	72	69	68	62	55	78
3 Descarga	58	72	72	77	77	71	65	60	82
3 Radiado	56	68	58	61	61	62	56	48	70
4 Aspiración	59	69	71	74	69	66	58	50	77
4 Descarga	58	71	75	79	79	71	63	56	83
4 Radiado	59	61	60	63	60	60	52	43	69
5 Aspiración	55	68	65	67	63	60	54	47	72
5 Descarga	56	66	68	72	71	64	58	51	76
5 Radiado	55	60	54	56	54	54	48	40	64
6 Aspiración	54	63	67	70	67	65	59	53	74
6 Descarga	56	64	69	74	74	68	62	57	78
6 Radiado	54	55	56	59	58	60	53	46	65
7 Aspiración	55	60	63	65	60	57	48	40	69
7 Descarga	57	63	66	70	69	61	53	46	74
7 Radiado	55	53	53	54	52	51	42	33	61
8 Aspiración	50	54	57	59	54	52	45	38	63
8 Descarga	52	58	59	63	61	56	48	41	67
8 Radiado	50	46	46	48	46	46	39	31	55
9 Aspiración	54	55	61	63	60	58	52	45	68
9 Descarga	56	58	63	68	67	61	55	50	72
9 Radiado	54	48	50	52	52	52	46	38	60
10 Aspiración	41	48	50	50	47	43	33	29	55
10 Descarga	42	52	52	56	54	47	38	31	60
10 Radiado	42	43	40	41	41	36	28	23	49
11 Aspiración	36	44	45	45	40	37	32	29	50
11 Descarga	38	50	46	49	46	39	34	29	55
11 Radiado	38	38	35	36	34	30	26	23	44
12 Aspiración	39	44	46	47	43	40	33	29	52
12 Descarga	37	50	47	50	48	42	36	30	55
12 Radiado	40	38	36	37	37	33	28	23	45

Espectros de nivel sonoro en dB(A)

Punto de trabajo	63	125	250	500	1.000	2.000	4.000	8.000	LwA
1 Aspiración	62	75	75	77	76	72	66	59	83
1 Descarga	61	78	81	84	85	77	71	63	89
1 Radiado	60	68	67	68	65	61	54	46	74
2 Aspiración	58	71	70	72	70	67	61	53	78
2 Descarga	58	73	77	80	79	71	64	58	84
2 Radiado	56	64	62	64	60	56	48	41	69
3 Aspiración	59	69	67	69	67	64	59	54	75
3 Descarga	57	69	72	75	74	67	61	55	79
3 Radiado	56	62	59	60	56	53	47	39	67
4 Aspiración	63	75	73	75	74	70	65	56	81
4 Descarga	61	78	79	83	83	75	69	61	88
4 Radiado	60	65	65	66	63	59	53	45	72
5 Aspiración	58	70	68	69	68	64	58	50	75
5 Descarga	58	73	75	77	76	68	62	56	82
5 Radiado	56	60	59	61	57	53	46	38	66
6 Aspiración	57	66	65	67	65	63	58	52	73
6 Descarga	56	69	70	73	72	65	59	53	78
6 Radiado	55	56	56	58	54	52	46	38	64
7 Aspiración	61	67	66	68	66	63	57	47	74
7 Descarga	60	69	73	76	76	67	63	53	81
7 Radiado	59	62	58	59	56	52	46	34	66
8 Aspiración	54	63	59	61	59	56	48	40	67
8 Descarga	54	63	66	68	67	60	55	50	73
8 Radiado	52	58	51	52	48	45	37	28	60
9 Aspiración	55	61	60	62	60	58	52	45	68
9 Descarga	55	63	65	68	67	60	55	48	73
9 Radiado	53	56	52	53	49	47	40	33	60
10 Aspiración	46	63	53	55	52	51	38	32	65
10 Descarga	47	63	59	61	60	56	44	36	68
10 Radiado	44	55	44	45	41	39	27	20	56
11 Aspiración	41	63	47	49	47	42	34	31	63
11 Descarga	42	63	53	54	52	46	40	33	64
11 Radiado	38	55	38	39	36	31	22	18	55
12 Aspiración	43	60	48	50	48	45	37	31	61
12 Descarga	41	58	52	55	54	51	47	44	62
12 Radiado	40	52	40	41	37	33	26	19	53

CURVAS CARACTERÍSTICAS

- q_v = Caudal en m^3/h y m^3/s .
- p_{sf} = Presión estática en mmcd a y Pa.
- SFP: Factor específico de potencia en $W/m^3/h$ (curvas azules).
- Energía de entrada en W.
- Ensayos realizados de acuerdo a Norma ISO 5801 y AMCA 210-99.

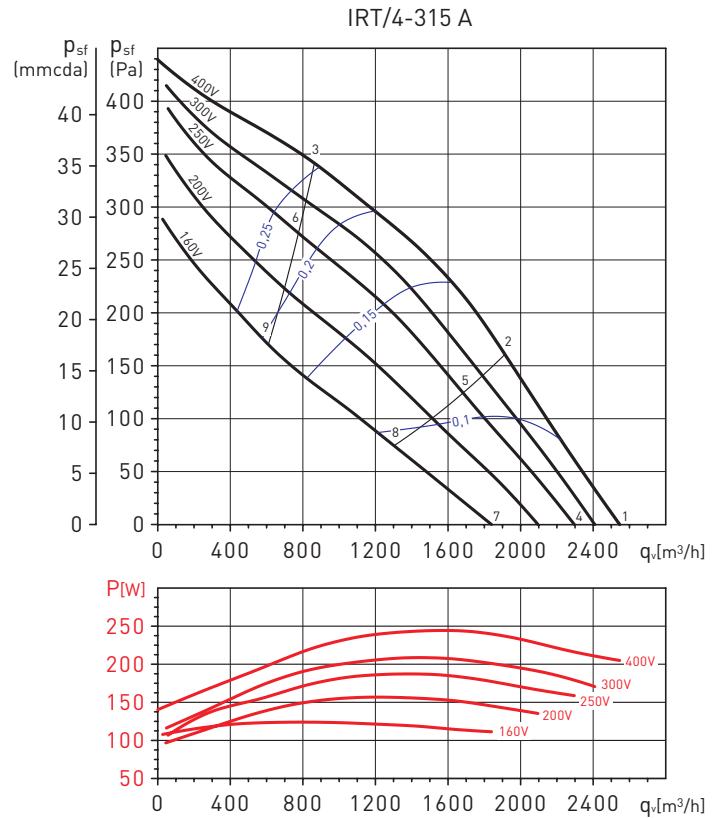
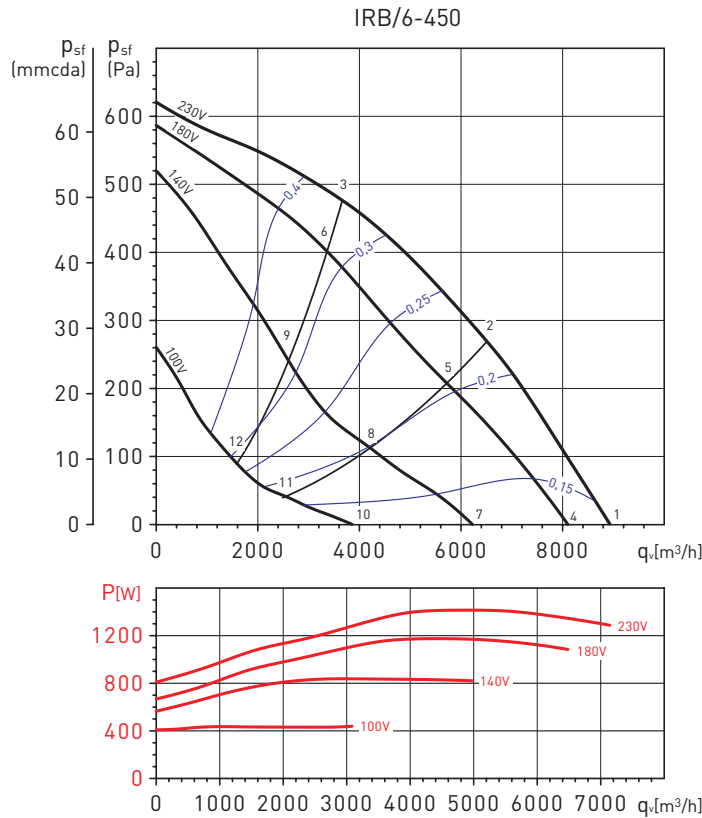

Espectros de nivel sonoro en dB(A)

Punto de trabajo	63	125	250	500	1.000	2.000	4.000	8.000	LwA	
1	Aspiración	67	77	79	81	80	74	67	61	86
	Descarga	69	82	85	88	88	80	73	67	93
	Radiado	64	72	74	75	71	63	53	48	80
2	Aspiración	64	74	75	76	75	69	63	56	81
	Descarga	67	76	81	83	82	75	69	63	88
	Radiado	61	68	69	70	66	59	49	44	75
3	Aspiración	63	70	72	73	73	69	63	57	79
	Descarga	66	73	76	79	78	72	67	61	83
	Radiado	59	65	67	68	65	58	50	45	72
4	Aspiración	68	75	76	77	76	70	64	55	83
	Descarga	69	81	82	85	84	76	70	62	90
	Radiado	65	70	71	71	67	59	50	43	77
5	Aspiración	67	71	70	71	69	64	57	50	77
	Descarga	72	75	76	79	77	70	65	58	84
	Radiado	65	66	65	65	60	53	43	37	72
6	Aspiración	61	69	69	70	69	66	59	54	76
	Descarga	66	71	75	78	77	72	67	61	83
	Radiado	59	64	63	64	60	54	46	41	70
7	Aspiración	64	72	67	68	65	60	54	43	75
	Descarga	70	80	73	75	73	66	60	50	83
	Radiado	62	68	62	62	56	49	40	31	70
8	Aspiración	64	76	63	61	58	55	47	38	76
	Descarga	68	76	67	69	67	64	58	48	78
	Radiado	61	71	57	56	49	44	33	26	72
9	Aspiración	66	73	63	63	61	58	52	45	75
	Descarga	72	78	68	71	70	65	59	54	81
	Radiado	64	68	58	57	52	47	38	33	70
10	Aspiración	56	72	58	56	52	51	41	32	72
	Descarga	55	70	61	62	59	55	46	34	72
	Radiado	55	66	55	52	45	42	30	22	67
11	Aspiración	57	71	57	52	48	45	39	30	72
	Descarga	55	68	57	57	56	50	44	33	69
	Radiado	55	66	54	48	41	36	28	21	67
12	Aspiración	58	74	57	54	50	48	41	32	74
	Descarga	56	68	58	59	60	54	49	37	70
	Radiado	56	68	54	50	43	39	30	22	69

Espectros de nivel sonoro en dB(A)

Punto de trabajo	63	125	250	500	1.000	2.000	4.000	8.000	LwA	
1	Aspiración	47	72	67	71	71	68	63	58	77
	Descarga	48	71	73	77	79	75	68	62	83
	Radiado	45	67	64	64	64	61	54	49	72
2	Aspiración	46	66	64	67	66	64	57	50	73
	Descarga	47	67	70	72	75	70	63	55	79
	Radiado	44	61	61	60	60	57	48	41	67
3	Aspiración	49	64	62	65	65	63	57	50	71
	Descarga	49	65	66	69	72	67	59	51	76
	Radiado	46	59	60	58	58	56	48	41	65
4	Aspiración	46	71	64	68	68	66	60	54	75
	Descarga	46	72	71	74	77	72	65	58	81
	Radiado	45	67	61	62	61	58	52	46	70
5	Aspiración	44	67	61	64	63	61	54	45	71
	Descarga	45	66	66	69	71	67	59	50	75
	Radiado	42	62	58	57	56	53	45	37	65
6	Aspiración	46	61	59	62	61	59	53	45	68
	Descarga	47	62	63	66	69	64	55	47	72
	Radiado	45	57	56	56	54	52	45	37	62
7	Aspiración	43	67	59	62	62	60	55	44	70
	Descarga	44	64	64	68	70	66	60	50	74
	Radiado	43	61	56	57	55	52	47	36	65
8	Aspiración	39	60	55	57	56	53	46	36	64
	Descarga	41	57	60	62	64	60	52	42	68
	Radiado	39	54	52	52	49	46	38	29	59
9	Aspiración	44	53	54	56	55	52	45	37	61
	Descarga	43	55	57	59	62	58	52	47	66
	Radiado	43	48	51	51	48	45	37	30	56

CURVAS CARACTERÍSTICAS

- q_v = Caudal en m^3/h y m^3/s .
- p_{sf} = Presión estática en mmcda y Pa.
- SFP: Factor específico de potencia en $W/m^3/h$ (curvas azules).
- Energía de entrada en W.
- Ensayos realizados de acuerdo a Norma ISO 5801 y AMCA 210-99.

IRT/4-315 B

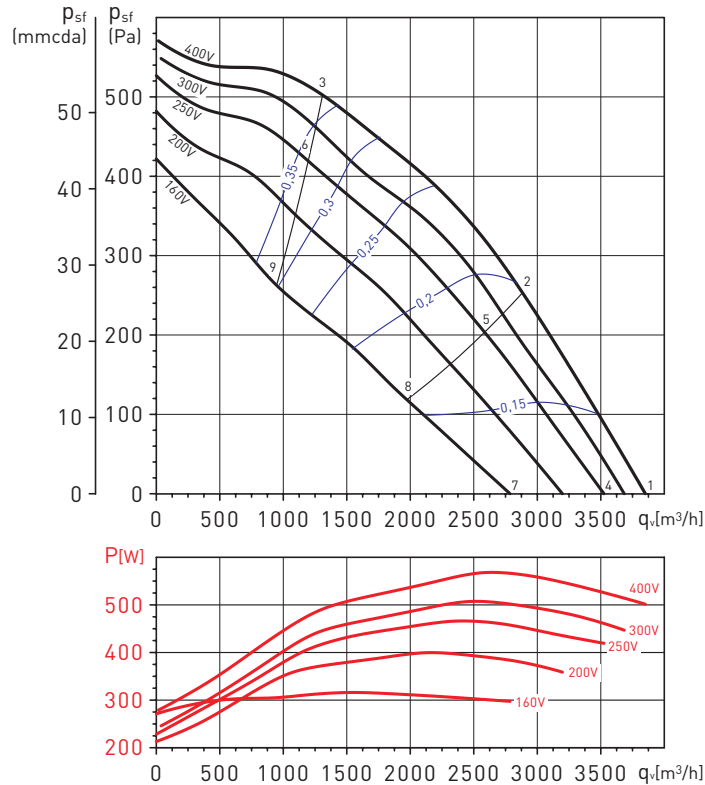

IRT/4-355

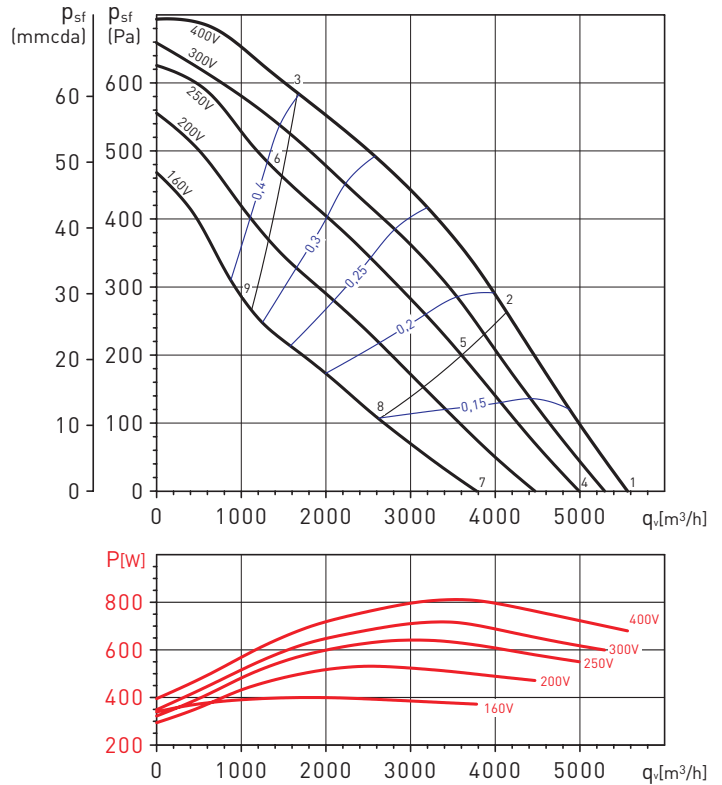

Espectros de nivel sonoro en dB(A)

Punto de trabajo	63	125	250	500	1.000	2.000	4.000	8.000	LwA
1 Aspiración	56	76	77	83	78	75	67	65	86
1 Descarga	57	77	82	85	86	82	73	68	90
1 Radiado	56	75	70	70	64	59	56	54	77
2 Aspiración	52	71	74	80	74	70	63	57	82
2 Descarga	55	73	78	81	82	76	69	62	86
2 Radiado	53	70	66	66	60	54	52	46	73
3 Aspiración	54	69	70	75	70	67	61	54	78
3 Descarga	56	72	74	76	77	72	65	57	82
3 Radiado	55	68	62	62	56	51	50	44	70
4 Aspiración	54	73	74	81	75	72	64	61	83
4 Descarga	55	77	79	82	83	78	70	66	88
4 Radiado	54	64	63	69	61	57	54	51	72
5 Aspiración	50	70	71	76	70	66	60	52	79
5 Descarga	53	72	75	77	78	73	65	58	83
5 Radiado	51	61	60	64	57	52	50	42	67
6 Aspiración	53	68	67	73	67	63	57	49	76
6 Descarga	54	70	71	74	74	68	62	54	79
6 Radiado	53	59	56	60	53	49	47	39	65
7 Aspiración	50	69	69	75	68	64	61	50	77
7 Descarga	52	71	73	76	76	71	65	55	81
7 Radiado	50	64	58	63	55	49	50	39	67
8 Aspiración	46	66	65	70	62	59	52	44	73
8 Descarga	49	65	68	71	70	64	58	49	75
8 Radiado	47	60	54	58	49	44	41	33	63
9 Aspiración	48	63	62	68	61	57	50	43	71
9 Descarga	49	66	64	68	67	61	55	45	73
9 Radiado	48	57	51	56	48	42	39	32	61

Espectros de nivel sonoro en dB(A)

Punto de trabajo	63	125	250	500	1.000	2.000	4.000	8.000	LwA
1 Aspiración	56	75	75	82	78	78	70	65	85
1 Descarga	58	77	81	86	88	82	75	68	91
1 Radiado	55	67	67	67	66	64	61	56	74
2 Aspiración	52	72	71	78	73	72	65	57	81
2 Descarga	55	74	78	82	83	76	68	61	87
2 Radiado	51	63	62	63	62	59	55	48	69
3 Aspiración	50	70	67	73	69	67	61	55	77
3 Descarga	52	70	74	77	78	70	64	57	82
3 Radiado	49	61	59	58	57	54	51	46	66
4 Aspiración	55	75	72	78	75	75	68	61	82
4 Descarga	56	74	78	82	84	78	71	64	88
4 Radiado	53	69	64	64	63	60	58	52	72
5 Aspiración	48	69	66	73	69	68	61	52	77
5 Descarga	52	71	74	77	79	71	64	56	83
5 Radiado	47	64	58	58	57	54	51	43	67
6 Aspiración	48	65	63	69	65	63	58	51	73
6 Descarga	51	66	70	73	74	66	60	52	78
6 Radiado	47	60	55	54	53	49	49	42	63
7 Aspiración	50	68	65	71	67	67	62	49	75
7 Descarga	52	69	71	75	76	70	64	53	80
7 Radiado	49	60	57	57	56	49	44	33	64
8 Aspiración	45	64	59	65	61	59	51	42	69
8 Descarga	47	65	66	68	69	61	54	45	73
8 Radiado	43	55	51	51	49	41	34	27	58
9 Aspiración	45	61	57	62	57	56	49	41	66
9 Descarga	48	61	62	65	65	58	51	42	70
9 Radiado	44	53	49	48	45	38	32	25	56

CURVAS CARACTERÍSTICAS

- q_v = Caudal en m^3/h y m^3/s .
- p_{sf} = Presión estática en mmcda y Pa.
- SFP: Factor específico de potencia en $W/m^3/h$ (curvas azules).
- Energía de entrada en W.
- Ensayos realizados de acuerdo a Norma ISO 5801 y AMCA 210-99.

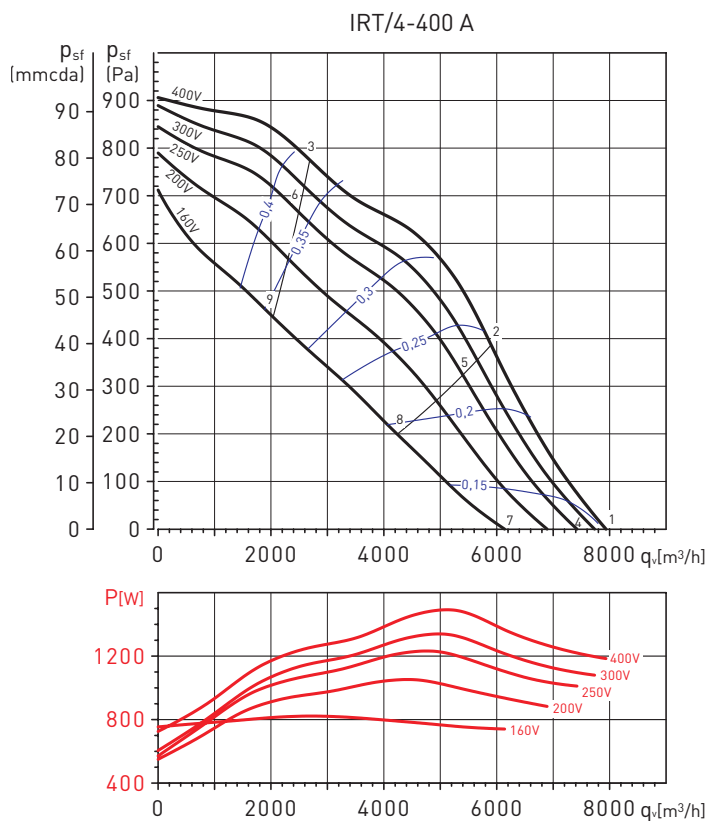
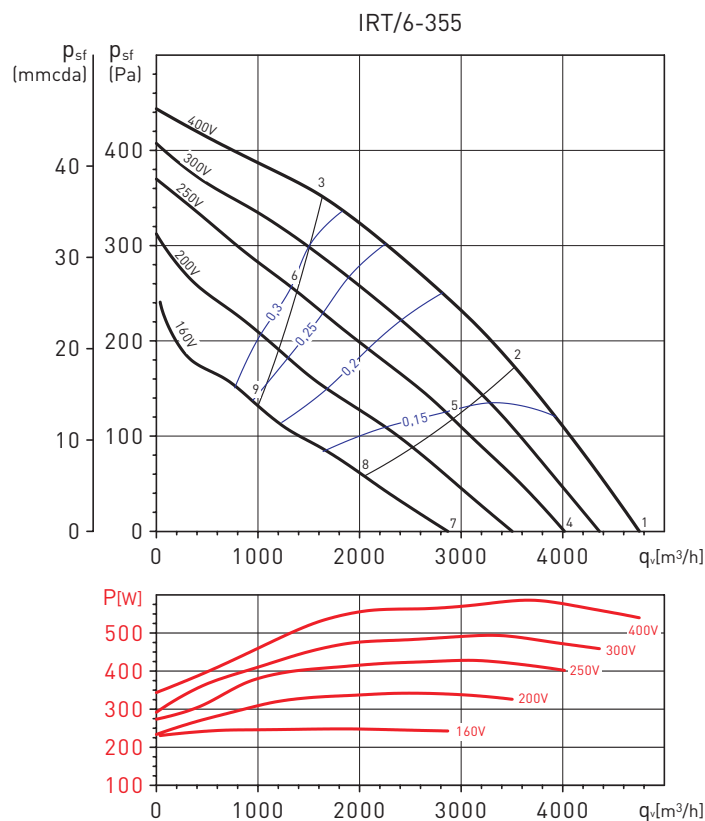

Espectros de nivel sonoro en dB(A)

Punto de trabajo	63	125	250	500	1.000	2.000	4.000	8.000	LwA	
1	Aspiración	61	72	75	78	73	70	64	54	82
	Descarga	61	76	78	82	82	75	68	60	87
	Radiado	61	62	61	62	60	54	49	40	69
2	Aspiración	58	70	72	74	69	66	60	52	78
	Descarga	58	72	74	78	77	70	64	57	82
	Radiado	59	60	58	58	55	50	45	38	65
3	Aspiración	59	74	71	74	70	68	61	55	79
	Descarga	61	74	73	77	77	71	65	59	82
	Radiado	59	65	57	58	56	52	46	41	67
4	Aspiración	61	67	71	73	68	64	58	48	77
	Descarga	61	69	73	77	77	69	63	54	81
	Radiado	61	56	57	57	54	48	44	34	65
5	Aspiración	60	64	67	69	64	60	54	46	73
	Descarga	57	65	69	72	72	65	58	52	77
	Radiado	60	53	54	53	50	45	40	33	63
6	Aspiración	58	63	67	69	65	63	56	50	73
	Descarga	57	62	69	72	72	66	59	54	77
	Radiado	59	52	53	54	51	47	42	36	62
7	Aspiración	52	58	63	64	58	55	46	37	68
	Descarga	53	60	64	67	66	59	50	42	71
	Radiado	51	51	49	48	44	40	32	25	57
8	Aspiración	49	54	59	59	54	50	43	35	64
	Descarga	50	56	60	62	61	54	47	39	67
	Radiado	48	47	46	44	40	35	29	23	53
9	Aspiración	50	53	60	61	57	54	47	39	65
	Descarga	51	54	61	64	63	57	50	44	69
	Radiado	48	47	47	46	43	39	33	27	54

Espectros de nivel sonoro en dB(A)

Punto de trabajo	63	125	250	500	1.000	2.000	4.000	8.000	LwA	
1	Aspiración	63	79	78	83	82	80	73	70	88
	Descarga	61	81	85	90	91	85	77	73	95
	Radiado	58	72	71	73	73	66	57	52	79
2	Aspiración	59	76	74	79	78	75	68	63	84
	Descarga	57	77	81	85	86	79	71	65	90
	Radiado	54	70	67	69	69	61	53	45	75
3	Aspiración	59	73	71	75	75	72	66	62	81
	Descarga	59	74	78	81	81	73	66	61	86
	Radiado	54	67	64	65	66	58	50	44	72
4	Aspiración	62	80	76	82	81	78	71	66	87
	Descarga	59	79	83	87	89	83	75	69	93
	Radiado	58	73	69	72	71	63	56	48	78
5	Aspiración	58	76	71	77	76	72	66	59	82
	Descarga	55	76	79	83	83	76	69	62	87
	Radiado	53	69	64	67	66	58	50	41	73
6	Aspiración	58	74	68	73	71	68	62	59	79
	Descarga	58	72	76	79	79	71	64	58	84
	Radiado	53	66	61	63	62	54	47	41	70
7	Aspiración	60	75	70	76	75	71	66	56	81
	Descarga	57	76	78	82	84	77	70	62	88
	Radiado	56	66	63	66	65	57	51	39	72
8	Aspiración	54	67	64	69	68	64	58	52	74
	Descarga	52	70	73	76	76	68	62	55	81
	Radiado	50	59	57	59	59	50	43	34	65
9	Aspiración	56	66	62	67	67	64	58	54	73
	Descarga	55	68	71	74	73	65	59	52	78
	Radiado	51	58	55	57	57	50	43	37	63

CURVAS CARACTERÍSTICAS

- q_v = Caudal en m^3/h y m^3/s .
- p_{sf} = Presión estática en mmcda y Pa.
- SFP: Factor específico de potencia en $W/m^3/h$ (curvas azules).
- Energía de entrada en W.
- Ensayos realizados de acuerdo a Norma ISO 5801 y AMCA 210-99.

IRT/4-400 B

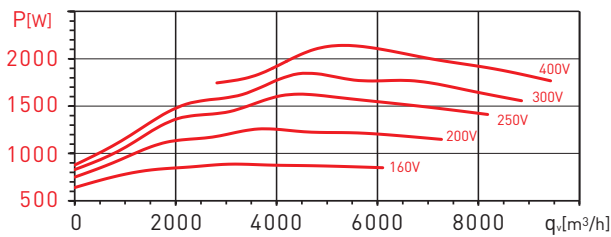
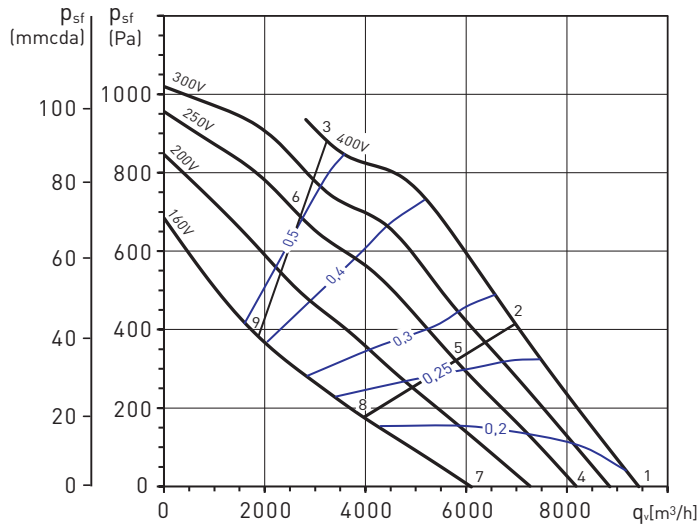

IRT/6-400

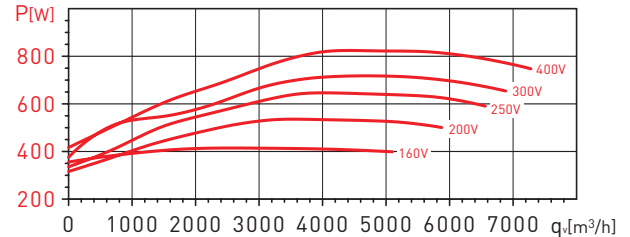
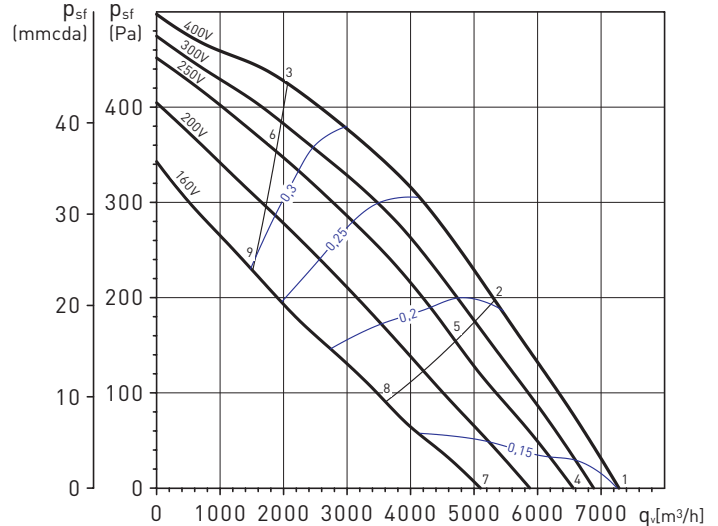

Espectros de nivel sonoro en dB(A)

Punto de trabajo	63	125	250	500	1.000	2.000	4.000	8.000	LwA
1 Aspiración	66	80	83	87	85	83	75	70	91
1 Descarga	62	85	89	93	93	89	81	75	98
1 Radiado	62	72	73	78	72	69	62	56	81
2 Aspiración	61	78	78	81	79	76	70	63	86
2 Descarga	59	80	83	87	87	80	73	66	92
2 Radiado	57	70	68	72	66	62	56	49	76
3 Aspiración	62	76	75	78	76	73	68	62	83
3 Descarga	62	77	81	84	84	77	71	66	89
3 Radiado	58	68	65	70	63	59	54	48	74
4 Aspiración	64	79	79	83	81	79	71	65	88
4 Descarga	61	82	85	89	89	85	76	70	94
4 Radiado	60	73	70	75	69	65	58	51	78
5 Aspiración	58	75	73	76	74	71	65	58	82
5 Descarga	56	76	80	82	82	74	67	61	87
5 Radiado	54	69	63	68	62	57	52	44	73
6 Aspiración	60	73	71	74	72	69	64	58	79
6 Descarga	59	73	77	80	79	73	66	61	84
6 Radiado	56	66	62	65	59	55	50	44	70
7 Aspiración	62	74	71	75	72	68	63	54	80
7 Descarga	58	76	78	80	80	74	67	60	85
7 Radiado	58	67	61	66	60	54	50	40	71
8 Aspiración	57	69	64	67	64	60	54	46	73
8 Descarga	57	74	71	72	71	64	57	51	79
8 Radiado	53	62	55	58	51	46	42	33	64
9 Aspiración	56	64	62	65	62	60	55	47	70
9 Descarga	55	67	68	71	70	64	58	53	76
9 Radiado	52	57	52	56	50	46	42	34	61

Espectros de nivel sonoro en dB(A)

Punto de trabajo	63	125	250	500	1.000	2.000	4.000	8.000	LwA
1 Aspiración	63	76	75	77	76	73	66	59	83
1 Descarga	62	78	81	84	85	78	71	64	89
1 Radiado	60	67	67	67	63	60	51	43	73
2 Aspiración	57	72	70	72	70	66	60	53	78
2 Descarga	57	73	77	79	78	71	64	58	84
2 Radiado	55	64	62	62	57	54	45	36	68
3 Aspiración	60	70	67	69	66	64	59	53	75
3 Descarga	58	70	72	75	74	67	61	55	79
3 Radiado	57	61	58	59	53	51	44	37	66
4 Aspiración	63	75	73	74	73	69	63	54	80
4 Descarga	62	78	78	81	81	74	68	60	86
4 Radiado	61	64	63	62	59	54	48	38	69
5 Aspiración	57	70	67	68	66	62	56	49	74
5 Descarga	59	73	73	75	74	67	60	54	80
5 Radiado	55	60	58	56	52	48	41	33	64
6 Aspiración	56	66	64	66	64	61	56	50	72
6 Descarga	56	69	69	71	70	64	58	52	76
6 Radiado	54	56	55	54	50	47	41	34	61
7 Aspiración	61	65	66	67	65	61	57	46	73
7 Descarga	59	67	72	74	74	66	62	52	79
7 Radiado	59	51	57	55	51	47	41	31	63
8 Aspiración	54	59	61	61	58	55	48	40	66
8 Descarga	53	61	66	68	66	59	53	46	72
8 Radiado	52	45	52	48	44	40	33	25	57
9 Aspiración	53	57	58	59	57	55	49	41	65
9 Descarga	52	59	63	65	64	57	51	45	69
9 Radiado	51	43	49	47	43	40	34	26	55

CURVAS CARACTERÍSTICAS

- q_v = Caudal en m^3/h y m^3/s .
- p_{sf} = Presión estática en mmcda y Pa.
- SFP: Factor específico de potencia en $W/m^3/h$ (curvas azules).
- Energía de entrada en W.
- Ensayos realizados de acuerdo a Norma ISO 5801 y AMCA 210-99.

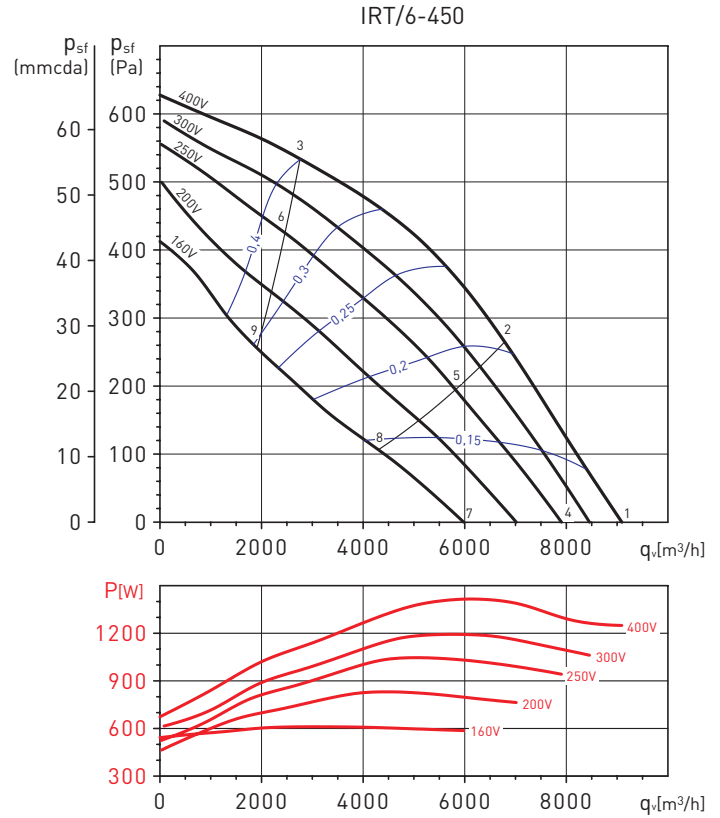
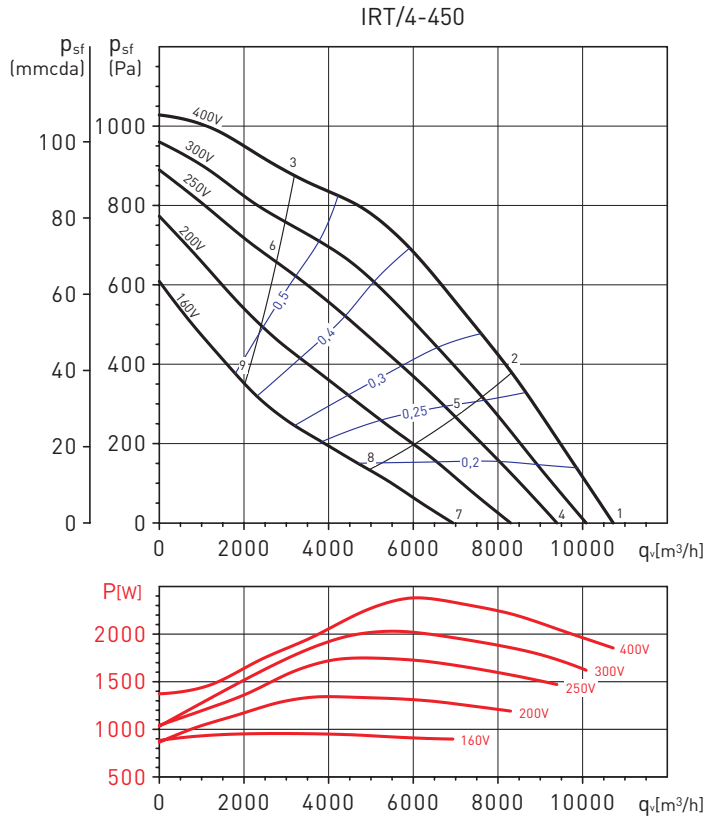

Espectros de nivel sonoro en dB(A)

Punto de trabajo	63	125	250	500	1.000	2.000	4.000	8.000	LwA	
1	Aspiración	67	80	84	88	87	85	77	72	93
	Descarga	65	87	89	93	94	90	81	75	98
	Radiado	61	76	79	81	78	75	64	60	85
2	Aspiración	64	77	81	84	83	79	72	66	88
	Descarga	62	84	85	89	90	83	75	69	94
	Radiado	58	73	75	77	74	69	59	54	81
3	Aspiración	62	73	77	80	78	76	70	65	85
	Descarga	60	77	81	85	84	78	72	67	89
	Radiado	56	69	72	72	70	65	57	53	77
4	Aspiración	65	79	80	84	83	80	72	68	89
	Descarga	63	83	86	89	90	85	76	70	94
	Radiado	58	75	75	77	74	70	59	55	82
5	Aspiración	61	75	75	79	77	74	67	61	84
	Descarga	60	78	81	84	84	77	70	63	89
	Radiado	54	72	70	71	68	63	54	48	77
6	Aspiración	59	70	72	75	73	70	65	60	80
	Descarga	58	73	77	80	79	73	67	62	84
	Radiado	52	67	67	68	64	60	52	47	73
7	Aspiración	62	73	72	76	74	70	64	54	81
	Descarga	60	76	78	81	81	75	67	58	86
	Radiado	55	68	68	69	65	60	51	41	74
8	Aspiración	59	66	66	69	66	62	56	49	74
	Descarga	60	71	72	74	73	66	59	52	79
	Radiado	53	62	61	62	58	52	44	36	67
9	Aspiración	55	63	64	66	64	61	56	49	71
	Descarga	56	65	68	71	70	64	59	53	76
	Radiado	48	59	59	58	55	51	43	36	64

Espectros de nivel sonoro en dB(A)

Punto de trabajo	63	125	250	500	1.000	2.000	4.000	8.000	LwA	
1	Aspiración	69	77	81	82	80	75	69	62	87
	Descarga	69	81	85	89	88	80	73	65	93
	Radiado	64	72	73	73	70	63	54	49	78
2	Aspiración	64	73	76	77	75	71	64	57	82
	Descarga	66	77	81	84	84	75	70	64	89
	Radiado	60	68	68	69	66	59	50	45	74
3	Aspiración	64	69	72	72	70	67	61	55	78
	Descarga	65	73	76	79	77	70	65	60	83
	Radiado	59	64	64	64	61	54	46	43	70
4	Aspiración	68	76	77	78	75	70	65	55	83
	Descarga	68	79	82	85	84	75	68	60	89
	Radiado	63	72	69	69	65	58	50	43	76
5	Aspiración	65	70	72	72	70	65	59	52	78
	Descarga	69	74	76	79	78	70	65	59	84
	Radiado	60	66	64	64	60	53	45	39	70
6	Aspiración	60	66	68	69	66	63	58	52	74
	Descarga	63	70	72	75	74	67	62	57	80
	Radiado	56	62	60	60	57	51	43	39	67
7	Aspiración	64	65	70	69	66	61	57	45	75
	Descarga	65	69	74	76	74	65	59	50	80
	Radiado	59	58	61	60	56	49	43	33	67
8	Aspiración	57	60	64	63	60	56	50	42	69
	Descarga	57	62	67	70	67	60	55	48	74
	Radiado	52	53	56	54	50	44	35	30	61
9	Aspiración	55	58	62	61	59	55	50	43	67
	Descarga	58	60	65	68	66	59	54	48	72
	Radiado	50	51	54	53	49	43	36	31	59

ACCESORIOS DE MONTAJE



IFL G4
Cajas filtrantes con filtros IFR-G4 incorporados. Accesorio no disponible para el modelo 180.



IFL-F
Cajas filtrantes, sin filtro, para montar filtros IFR-F.
IFR-F
Filtros para instalar en las cajas filtrantes IFL-F. Accesorio no disponible para el modelo 180.



IBE
Baterías eléctricas. Accesorio no disponible para el modelo 180.



IBW
Baterías de agua caliente. Accesorio no disponible para el modelo 180.



IBR
Bridas.



IAE
Acoplamientos elásticos.

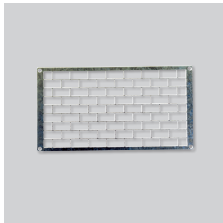

DEF
Defensas protección.



ISA
Soportes antivibratorios. (1 ISA = 4 soportes)



IAA
Atenuadores eléctricos. Accesorio no disponible para el modelo 180.



IJK
Compuertas motorizadas. Como accesorio: Servomotor LM230A. Accesorio no disponible para el modelo 180.

ACCESORIOS ELÉCTRICOS



RMB/RMT
Reguladores de velocidad electromecánicos monofásicos (RMB) y trifásicos (RMT).



VFKB IP65
Convertidores de frecuencia para motores de 0,37 a 4 kW - 230V ó 400V.



VFTM IP21
Convertidor de frecuencia es para motores trifásicos.

Modelo	Convertidores de frecuencia			
	Alimentación monofásica 230V-50/60Hz		Alimentación trifásica 400V-50/60Hz	
	VFKB	VFTM	VFKB	VFTM
IRT/4-315 A	VFKB-24	VFTM MONO 0,18	VFKB-45	VFTM TRI 0,37
IRT/4-315 B	VFKB-24	VFTM MONO 0,37	VFKB-45	VFTM TRI 0,37
IRT/4-355	VFKB-24	VFTM MONO 0,37	VFKB-45	VFTM TRI 0,55
IRT/6-355	VFKB-24	VFTM MONO 0,37	VFKB-45	VFTM TRI 0,37
IRT/4-400 A	VFKB-27	VFTM MONO 1,1	VFKB-45	VFTM TRI 1,5
IRT/4-400 B	-	VFTM MONO 1,1	VFKB-45	VFTM TRI 1,5
IRT/6-400	VFKB-24	VFTM MONO 0,55	VFKB-45	VFTM TRI 0,75
IRT/4-450	-	VFTM MONO 1,5	VFKB-45	VFTM TRI 2,2
IRT/6-450	VFKB-27	VFTM MONO 1,1	VFKB-45	VFTM TRI 1,5



DPS 2-30
Presostatos para comprobar el buen estado de los filtros o de las baterías.



LM-230A
Servomotor para compuertas.



TTC-2000
TTC-2000 + TTS-1
TTC-40F + TTS-4
Reguladores para baterías eléctricas.



Sondas de temperatura
TG-K330 de conducto.
TG-R530 de ambiente.



SC02-A
Sensor de CO₂ y temperatura.
SC02-AD
Sensor de CO₂ y temperatura. Con display.
SCHT-AD
Sensor de CO₂, temperatura y humedad relativa. Con display.



CPTA-S N / CPTA-E N
Detectores de presencia.



TDP-S/TDP-D/TDP-PI
Transmisores de presión.