



Ventiladores helicoidales murales con hélice "Sickle" equilibrada en dos planos, de bajo nivel sonoro, protegidos contra la corrosión mediante tratamiento por cataforesis y pintados con poliéster (1), motor de rotor exterior monofásico (HXBR) o trifásico (HXTR), IP44 (modelos 250 a 355) ó IP54 (modelos 400 a 800), Clase F, con protector térmico incorporado y caja de bornes con condensador incorporado en los modelos monofásicos.

(1) Modelo 800: motor-hélice sin pintar.

Motores

De 2, 4, 6, 8 ó 12 polos, según versiones.

Tensión de alimentación:

Monofásicos 230V-50Hz

Trifásicos 400V-50Hz

230/400V-50Hz (modelos 250)

Modelos trifásicos con motores regulables por variación de frecuencia. (Ver cuadro de características).

Otros datos

Sentido del aire Motor-Hélice (flujo A).

Bajo demanda, modelos trifásicos 230/400V-50Hz.



Gran compacidad

Especial diseño del conjunto motor-hélice, que proporciona gran compacidad.



Resistencia a la corrosión

Conjunto metálico marco-rejilla protegido contra la corrosión mediante tratamiento por cataforesis + pintura poliéster. Tornillería inoxidable.



Caja de bornes

Contiene el condensador en los modelos monofásicos.



Hélice "Sickle" de alto rendimiento

Hélices con especial diseño "Sickle", de alto rendimiento y bajo nivel sonoro, equilibradas dinámicamente según norma ISO 1940.

Fabricadas en aluminio; los modelos de Ø 250 a 355, en acero galvanizado.

CARACTERÍSTICAS TÉCNICAS

Es imprescindible comprobar que las características eléctricas (voltaje, intensidad, frecuencia, etc.) del motor que aparecen en la placa del mismo son compatibles con las de la instalación.

Modelo	Velocidad (r.p.m.)	Ø Boca (mm)	Tensión	Potencia absorbida máxima (W)	Intensidad máxima (A)		Nivel de presión sonora* (dB(A))	Caudal máximo (m³/h)	Temperatura de trabajo (°C)	Peso (kg)	Regulador de tensión opcional		Convertidor de frecuencia opcional
					a 230 V	a 400 V					REB	RMB/T	
MONOFÁSICOS 2 POLOS													
HXBR/2-200-A	2780	200	230V 50Hz	80	0,4	-	56	810	-40/+60	4	REB-1	RMB-1,5	-
HXBR/2-250-A	2800	250	230V 50Hz	112	0,5	-	61	1.560	-40/+60	7	REB-1	RMB-1,5	-
MONOFÁSICOS 4 POLOS													
HXBR/4-250-A	1440	250	230V 50Hz	42	0,2	-	47	760	-40/+60	6,5	REB-1	RMB-1,5	-
HXBR/4-315-A	1445	315	230V 50Hz	112	0,6	-	53	1.950	-40/+40	7	REB-1	RMB-1,5	-
HXBR/4-355-A	1400	355	230V 50Hz	145	0,7	-	59	2.870	-40/+60	7,5	REB-1	RMB-1,5	-
HXBR/4-400-A	1395	400	230V 50Hz	268	1,2	-	61	5.080	-40/+65	9	REB-2,5	RMB-1,5	-
HXBR/4-450-A	1395	450	230V 50Hz	457	2	-	64	7.040	-40/+50	11,5	REB-2,5	RMB-3,5	-
HXBR/4-500-A	1425	500	230V 50Hz	867	3,6	-	67	8.770	-40/+70	16	REB-5	RMB-3,5	-
HXBR/4-560-A	1420	560	230V 50Hz	1084	4,6	-	69	11.210	-40/+45	21,5	REB-5	RMB-5	-
HXBR/4-630-A	1455	630	230V 50Hz	1252	5,5	-	67	14.010	-40/+40	24	-	-	-
MONOFÁSICOS 6 POLOS													
HXBR/6-400-A	935	400	230V 50Hz	124	0,6	-	49	3.300	-40/+50	9	REB-1	RMB-1,5	-
HXBR/6-450-A	935	450	230V 50Hz	138	0,6	-	53	4.370	-40/+70	11,5	REB-1	RMB-1,5	-
HXBR/6-500-A	925	500	230V 50Hz	228	1,1	-	57	5.560	-40/+70	16	REB-2,5	RMB-3,5	-
HXBR/6-560-A	930	560	230V 50Hz	331	1,6	-	60	7.500	-40/+65	21,5	REB-2,5	RMB-3,5	-
HXBR/6-630-A	915	630	230V 50Hz	587	2,6	-	61	11.380	-40/+40	24	REB-5	RMB-3,5	-
TRIFÁSICOS 2 POLOS													
HXTR/2-250-A	2800	250	230/400V 50Hz	112	0,7	0,4	61	1.530	-40/+60	7	-	-	Tri 0,37
TRIFÁSICOS 4 POLOS													
HXTR/4-250-A	1475	250	230/400V 50Hz	47	0,4	0,2	47	770	-40/+60	6,5	-	RMT-1,5	Tri 0,37
HXTR/4-315-A	1450	315	400V 50Hz	98	-	0,3	53	2.020	-40/+70	7	-	RMT-1,5	Tri 0,37
HXTR/4-355-A	1410	355	400V 50Hz	145	-	0,4	59	2.890	-40/+70	7,5	-	RMT-1,5	Tri 0,37
HXTR/4-400-A	1400	400	400V 50Hz	236	-	0,5	61	4.620	-40/+60	9	-	RMT-1,5	Tri 0,37
HXTR/4-450-A	1420	450	400V 50Hz	450	-	0,9	64	6.910	-40/+60	11,5	-	RMT-1,5	Tri 0,37
HXTR/4-500-A	1410	500	400V 50Hz	891	-	1,7	67	9.550	-40/+70	16	-	RMT-2,5	Tri 0,55
HXTR/4-560-A	1410	560	400V 50Hz	1201	-	2,4	69	12.040	-40/+70	21,5	-	-	Tri 0,75
HXTR/4-630-A	1420	630	400V 50Hz	1066	-	2,2	67	13.720	-40/+60	24	-	-	Tri 0,75
TRIFÁSICOS 6 POLOS													
HXTR/6-400-A	875	400	400V 50Hz	123	-	0,5	52	3.610	-40/+70	9	-	RMT-1,5	Tri 0,37
HXTR/6-450-A	930	450	400V 50Hz	143	-	0,3	53	4.360	-40/+60	11,5	-	RMT-1,5	Tri 0,37
HXTR/6-500-A	925	500	400V 50Hz	222	-	0,4	57	5.720	-40/+70	16	-	RMT-1,5	Tri 0,37
HXTR/6-560-A	950	560	400V 50Hz	405	-	0,9	60	8.220	-40/+70	21,5	-	RMT-1,5	Tri 0,37
HXTR/6-630-A	895	630	400V 50Hz	607	-	1,1	61	11.070	-40/+60	24	-	RMT-1,5	Tri 0,37
HXTR/6-710-A	930	710	400V 50Hz	1019	-	2,2	62	16.110	-40/+40	27	-	-	Tri 0,75
HXTR/6-800-A	920	800	400V 50Hz	1909	-	3,8	63	24.380	-40/+50	46	-	-	Tri 1,5
TRIFÁSICOS 8 POLOS													
HXTR/8-800-A	655	800	400V 50Hz	802	-	1,5	55	17.510	-40/+70	45	-	RMT-2,5	Tri 0,37
TRIFÁSICOS 12 POLOS													
HXTR/12-800-A	455	800	400V 50Hz	294	-	0,7	48	11.790	-40/+70	43	-	-	Tri 0,37

* Nivel de presión sonora, medida en campo libre, a una distancia equivalente a tres veces el diámetro de la hélice, con un mínimo de 1,5 metros.

CARACTERÍSTICAS ACÚSTICAS

El nivel sonoro indicado en los cuadros de características técnicas de los ventiladores S&P, corresponde generalmente a un valor de presión en dB(A), medido en campo libre a una distancia de 1,5 metros.

Espectro de potencia sonora en dB(A) por banda de frecuencia en Hz.

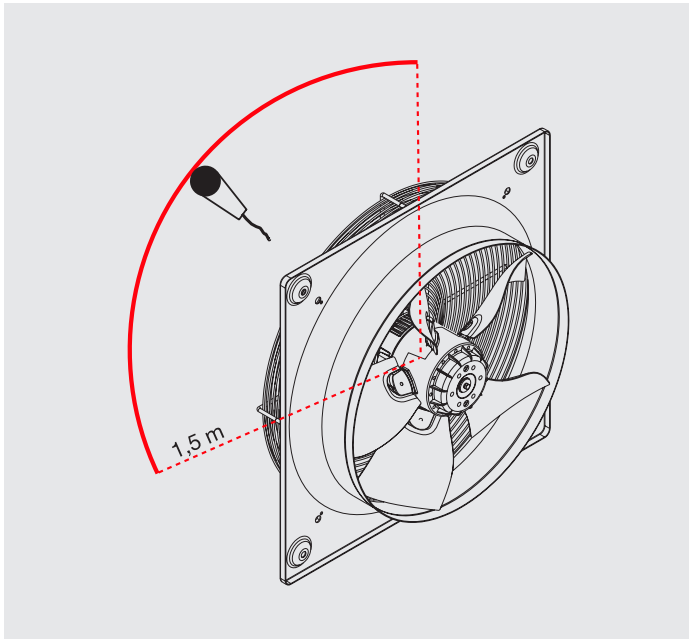

Modelo	63	125	250	500	1.000	2.000	4.000	8.000	LwA
2-200	37	42	64	64	65	64	58	49	71
2-250	43	51	66	65	70	71	67	61	76
4-250	29	37	52	51	56	57	53	47	61
4-315	38	50	53	62	62	62	57	47	67
4-355	37	54	58	64	70	68	62	52	73
4-400	40	59	63	69	72	70	64	58	76
4-450	43	61	72	73	73	72	66	61	79
4-500	43	61	69	75	78	74	68	64	81
4-560	51	66	74	78	81	78	72	67	85
4-630	54	70	75	76	79	77	72	66	84
B/6-400	28	47	51	57	60	58	52	46	64
T/6-400	30	49	53	59	62	60	54	48	66
6-450	32	50	61	62	62	61	55	50	67
6-500	33	51	59	65	68	64	58	54	72
6-560	41	56	64	68	71	68	62	57	75
6-630	48	64	69	70	73	71	66	60	78
6-710	56	63	70	73	76	73	67	63	80
6-800	46	62	68	71	79	75	70	62	82
8-800	38	54	60	63	71	67	62	54	74
12-800	31	47	53	56	64	60	55	47	67

DIMENSIONES (mm)

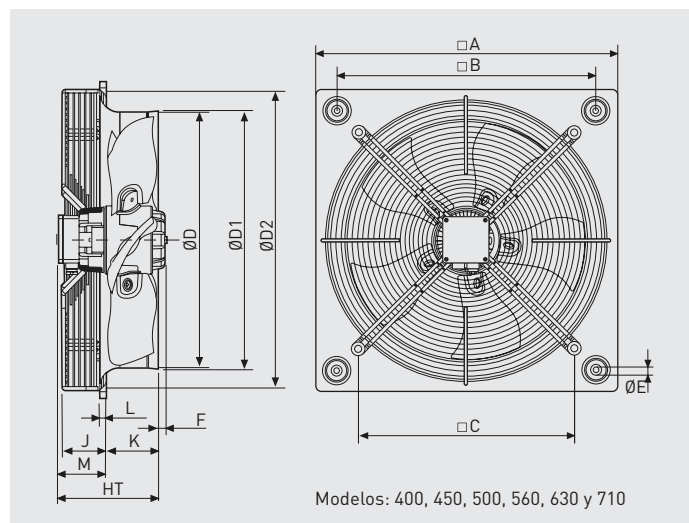
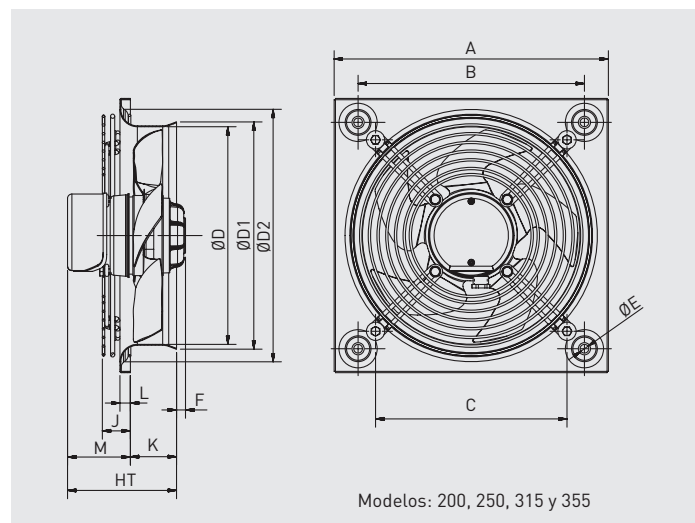

Modelo	A	B	C	D	D1	D2	E	F						HT		J	K	L	M			
								Monofásico			Trifásico			Monofásico	Trifásico				Monofásico	Trifásico	Monofásico	Trifásico
								/2	/4	/6	/2	/4	/6									
200	312	260	173	200	203	227	4,5	25,5	-	-	-	-	-	100	-	13	46	6	54	-		
250	315	260	220	250	261	294	10	10,5	0	-	10,5	0	-	126	126	33	53	12	73	73		
315	400	330	280	315	320	329	10	-	0	-	-	0	-	149	149	41	68	12	82	82		
355	450	380	315	355	363	371	10	-	0	-	-	0	-	156	156	41	75	12	82	82		
400	500	420	355	400	410	422	10	-	12	0	-	0	0	200	176	92	78	12	122	97		
450	560	480	400	450	457	476	10	-	0	0	-	0	0	204	179	68	91	12	114	89		
500	630	560	450	500	512	536	10	-	13	0	-	13	0	201	176	60	97	12	104	79		
560	710	630	510	560	570	596	10	-	20	2	-	20	0	213	188	70	99	12	114	89		
630	800	710	580	630	640	674	12	-	25	25	-	25	7	207	182	60	103	12	104	79		
710	900	800	637	710	720	733	12	-	-	-	-	-	11	-	206	115	92	17	-	115		

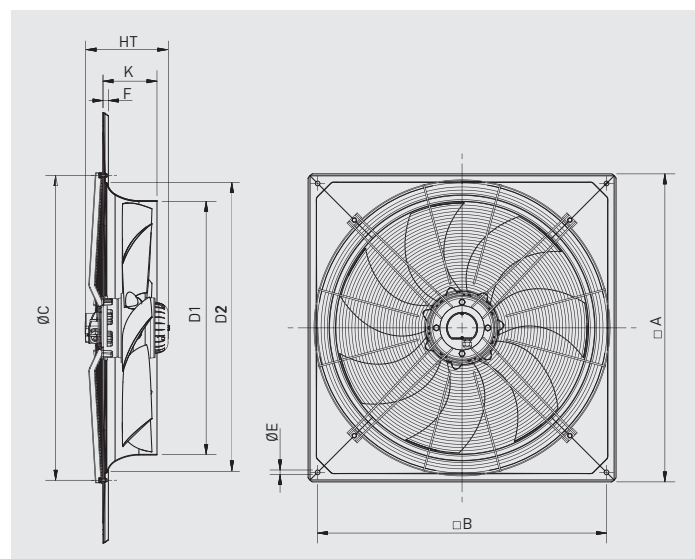

Modelo	A	B	C	D1	D2	E	F	HT	K
6-800	970	910	960	797	914	14,5	17	262	170
8-800	970	910	960	797	914	14,5	17	245	170
12-800	970	910	960	797	914	14,5	17	467	170

CURVAS CARACTERÍSTICAS – MOTOR DE 2 POLOS

- q_v : Caudal en m^3/h y m^3/s .
- p_{sf} : Presión estática en Pa y mmcda.
- p_g : Pérdida de carga de la defensa en Pa.
- SFP: Factor específico de potencia en $W/m^3/s$.
- P: Potencia absorbida en W.
- Categoría de medición: A.
- Categoría de eficiencia: estática.
- Eficiencia del ventilador sin mando de regulación de velocidad.
- Pruebas efectuadas con el ventilador sin defensa.
- Caudal de acuerdo a la Norma ISO 5801.
- Nivel de presión sonora en dB(A), medido en campo libre a una distancia equivalente a 3 veces el diámetro, con un mínimo de 1,5 m.

MC	Categoría de medición
EC	Categoría de eficiencia
VSD	Mando de regulación de velocidad: debe suministrarse con el ventilador
SR	Relación específica
η[%]	Eficiencia
N	Grado de eficiencia
[kW]	Potencia absorbida
[m³/h]	Caudal
[Pa]	Presión estática
[RPM]	Velocidad

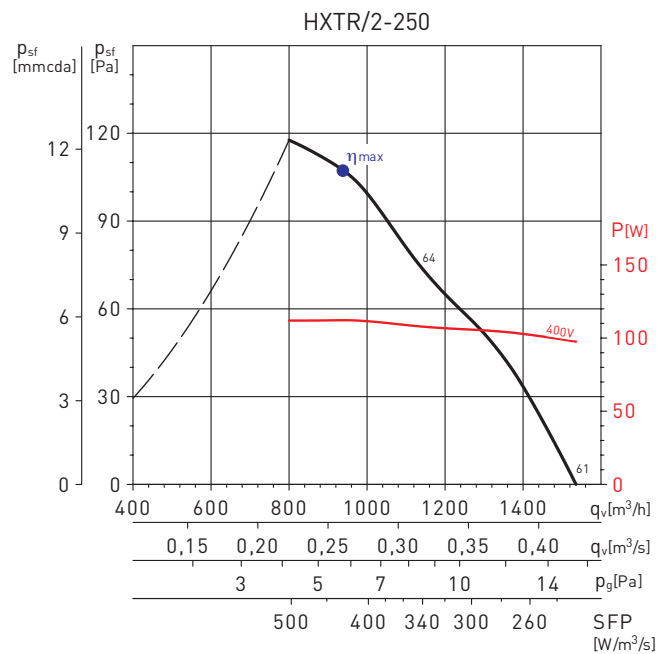
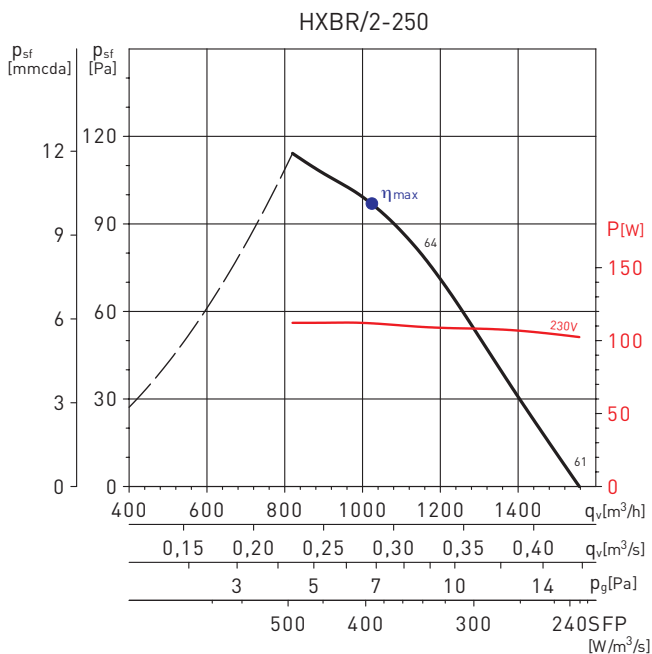
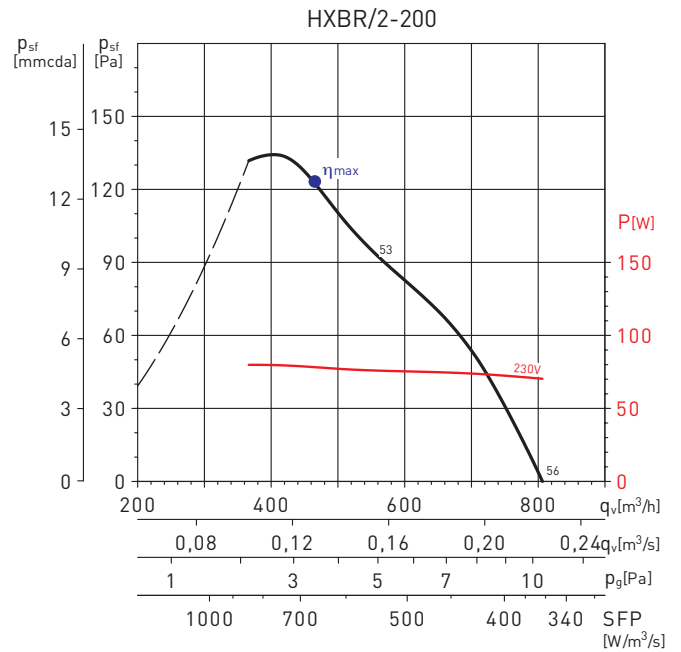

CURVAS CARACTERÍSTICAS – MOTOR DE 4 POLOS

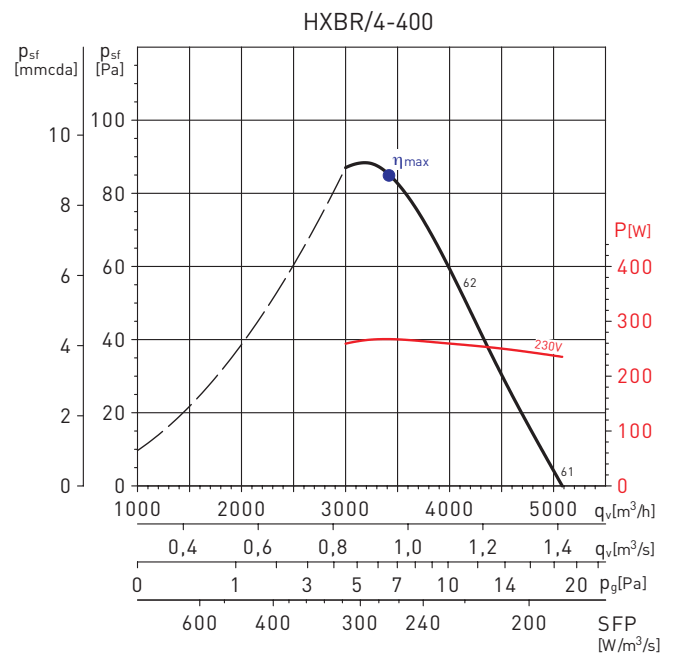
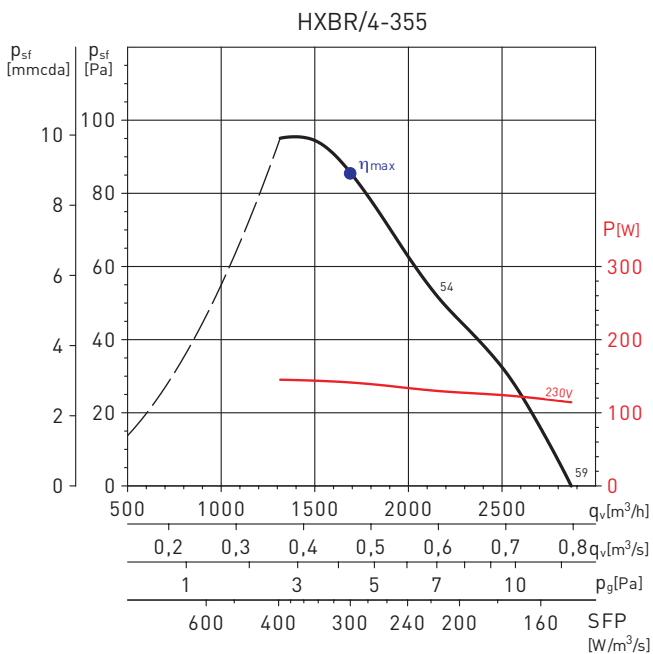
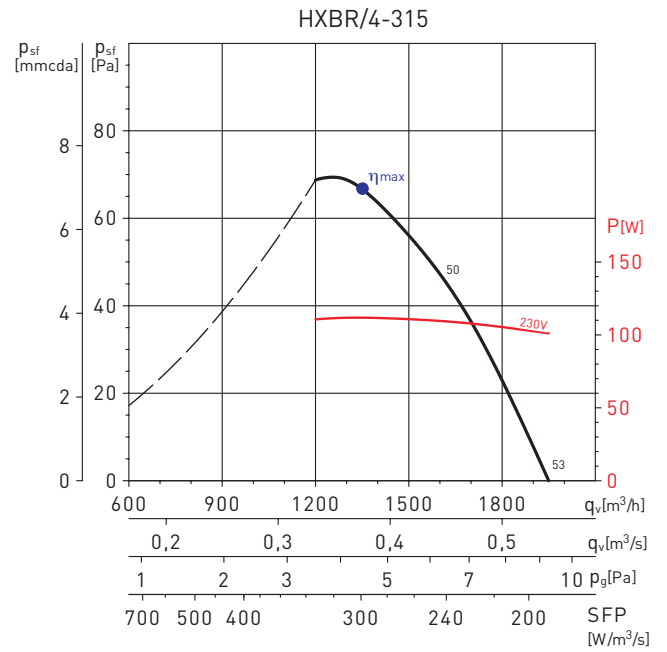
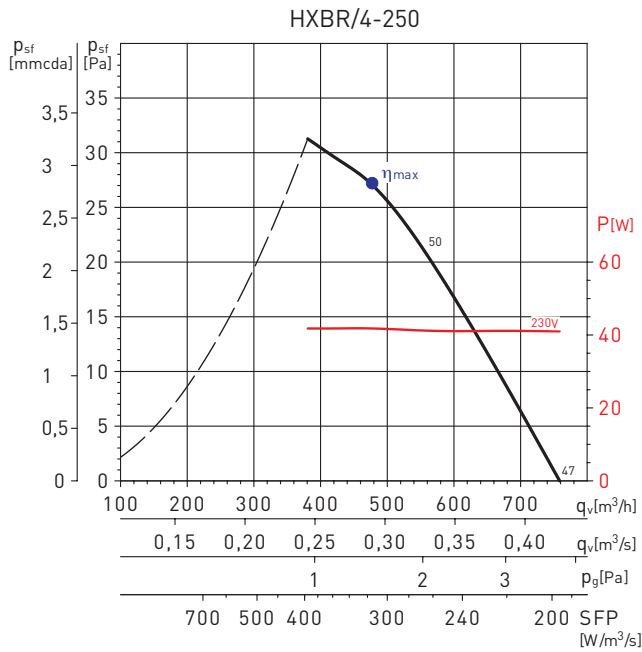

MC	EC	VSD	SR	η [%]	N	[kW]	[m³/h]	[Pa]	[RPM]
A	Static	No	1	30,4	42,0	0,144	1820	87	1373

MC	EC	VSD	SR	η [%]	N	[kW]	[m³/h]	[Pa]	[RPM]
A	Static	No	1	30,1	40,0	0,268	3416	85	1364

CURVAS CARACTERÍSTICAS – MOTOR DE 4 POLOS

HXBR/4-450

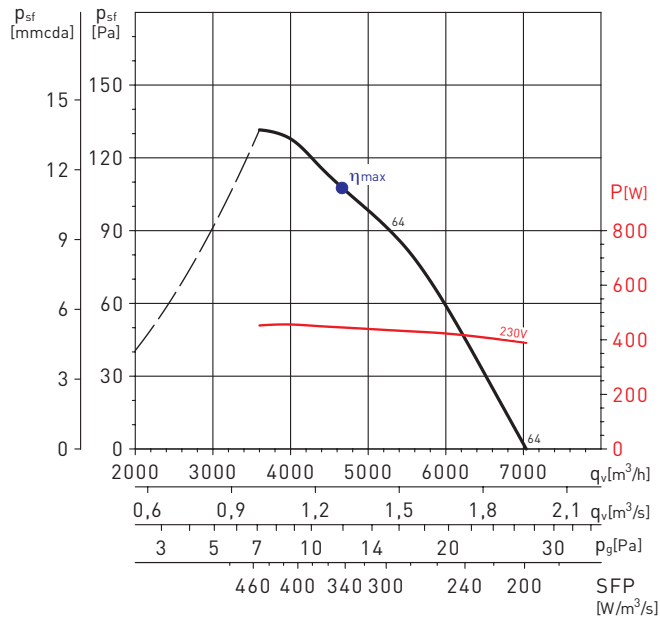

MC	EC	VSD	SR	η [%]	N	[kW]	[m³/h]	[Pa]	[RPM]
A	Static	No	1	31,5	40,0	0,450	4374	117	1363

HXBR/4-500

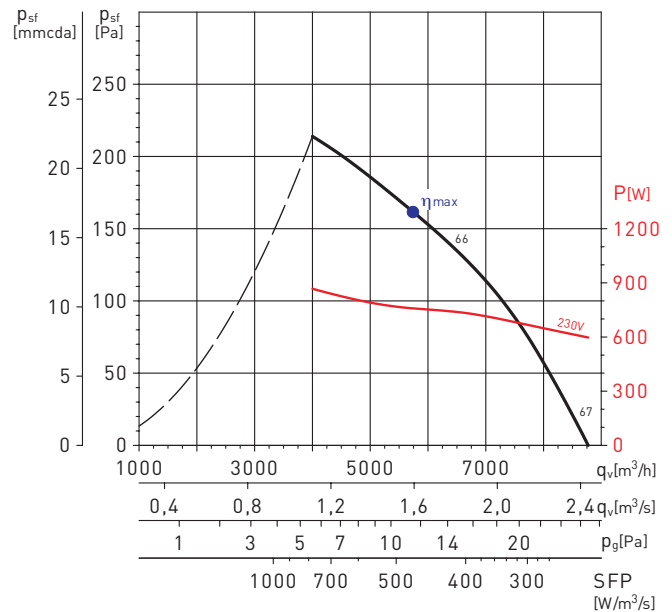

MC	EC	VSD	SR	η [%]	N	[kW]	[m³/h]	[Pa]	[RPM]
A	Static	No	1	34,0	41,1	0,759	5736	162	1383

HXBR/4-560

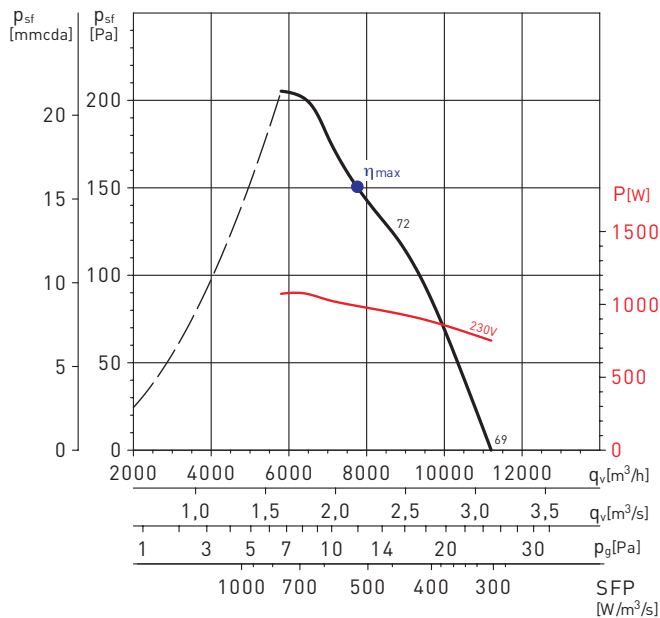

MC	EC	VSD	SR	η [%]	N	[kW]	[m³/h]	[Pa]	[RPM]
A	Static	No	1	33,8	40,0	1,040	6875	184	1370

HXBR/4-630

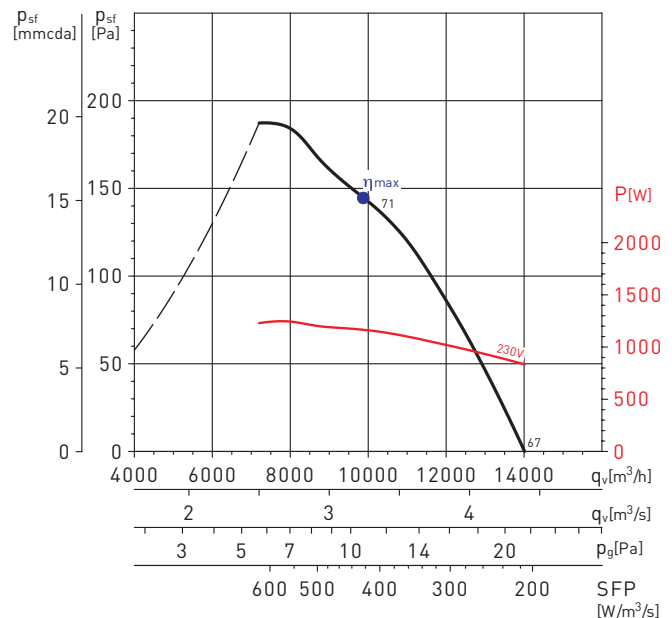

MC	EC	VSD	SR	η [%]	N	[kW]	[m³/h]	[Pa]	[RPM]
A	Static	No	1	34,2	40,2	1,145	10316	137	1426

CURVAS CARACTERÍSTICAS - MOTOR DE 4 POLOS

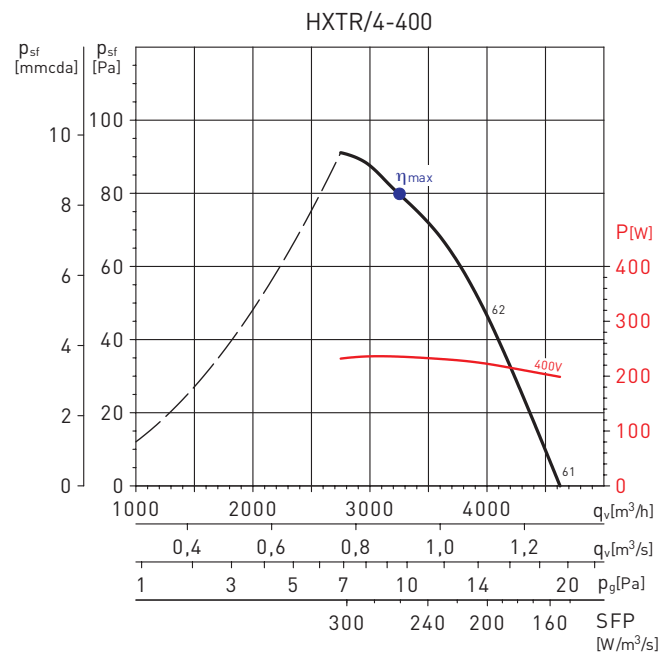
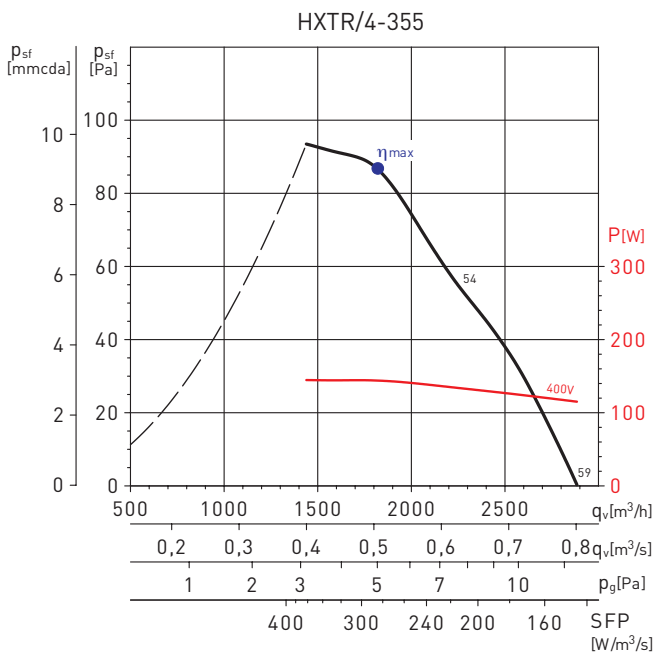
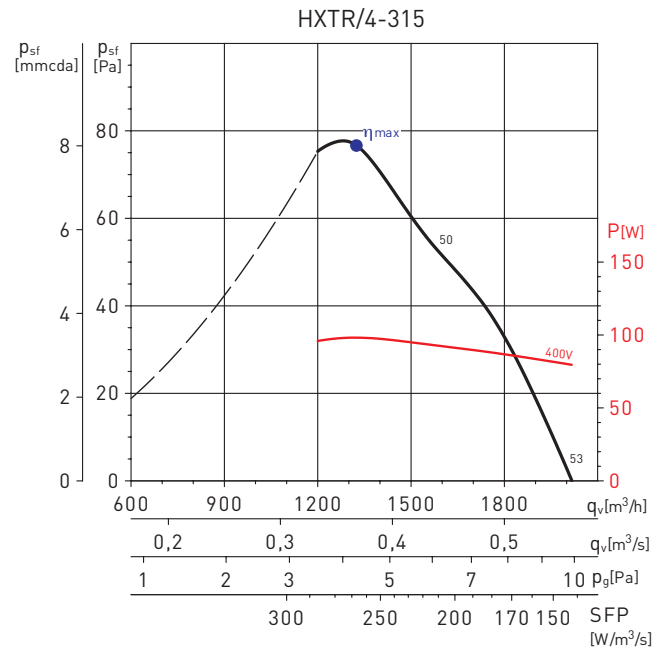
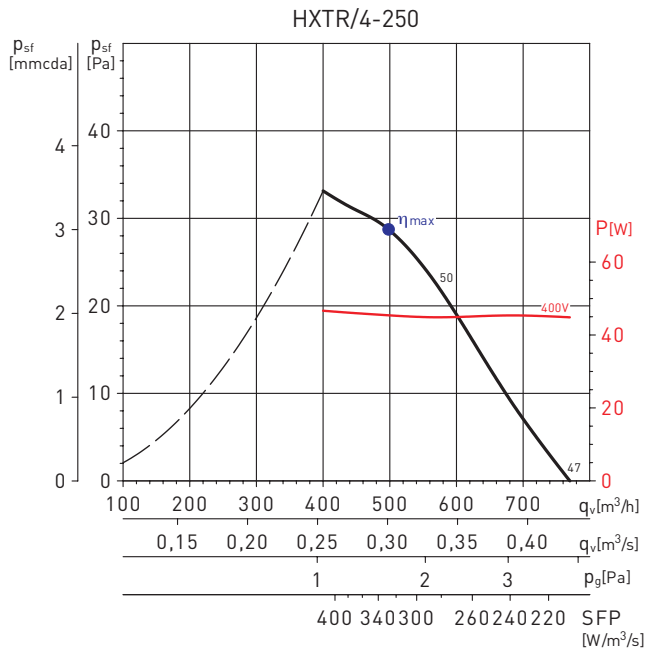

MC	EC	VSD	SR	η [%]	N	[kW]	[m³/h]	[Pa]	[RPM]
A	Static	No	1	30,4	42,0	0,144	1820	87	1373

MC	EC	VSD	SR	η [%]	N	[kW]	[m³/h]	[Pa]	[RPM]
A	Static	No	1	30,8	41,1	0,236	2991	88	1382

CURVAS CARACTERÍSTICAS – MOTOR DE 4 POLOS

HXTR/4-450

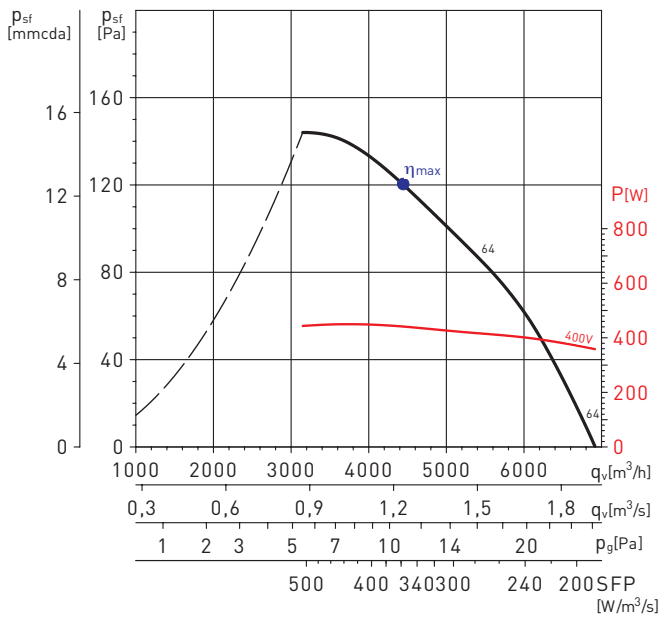

MC	EC	VSD	SR	η [%]	N	[kW]	[m^3/h]	[Pa]	[RPM]
A	Static	No	1	33,6	42,2	0,441	4439	120	1401

HXTR/4-500

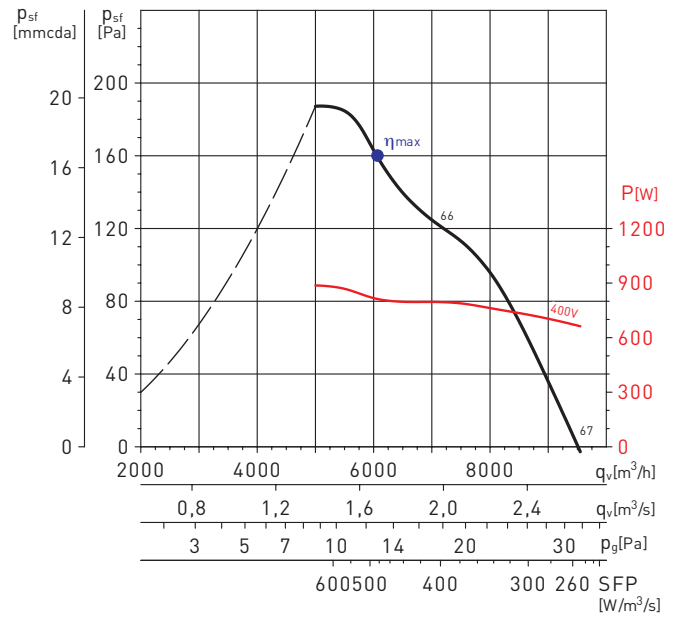

MC	EC	VSD	SR	η [%]	N	[kW]	[m^3/h]	[Pa]	[RPM]
A	Static	No	1	33,3	40,1	0,829	5863	170	1377

HXTR/4-560

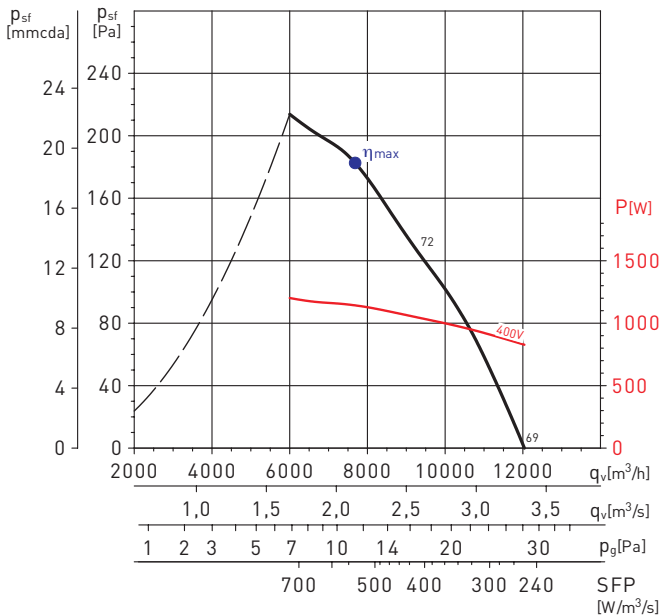

MC	EC	VSD	SR	η [%]	N	[kW]	[m^3/h]	[Pa]	[RPM]
A	Static	No	1	34,0	40,0	1,143	7680	183	1357

HXTR/4-630

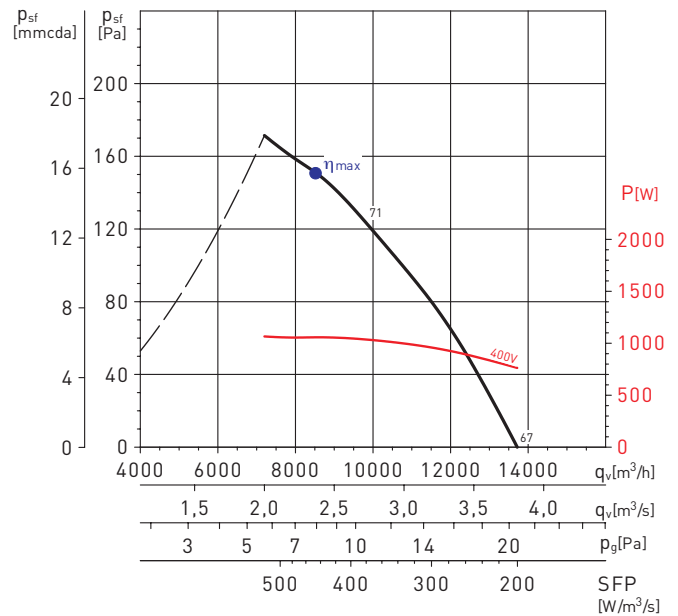

MC	EC	VSD	SR	η [%]	N	[kW]	[m^3/h]	[Pa]	[RPM]
A	Static	No	1	33,8	40,0	1,058	8536	151	1385

CURVAS CARACTERÍSTICAS - MOTOR DE 6 POLOS

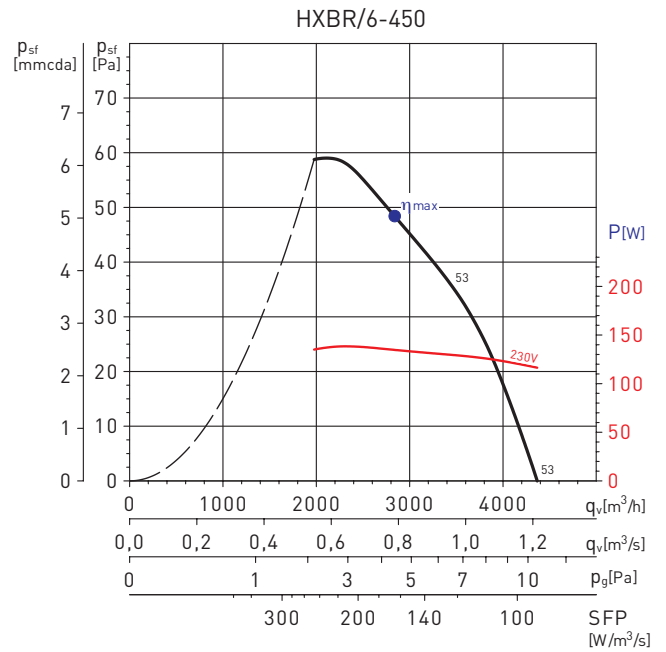
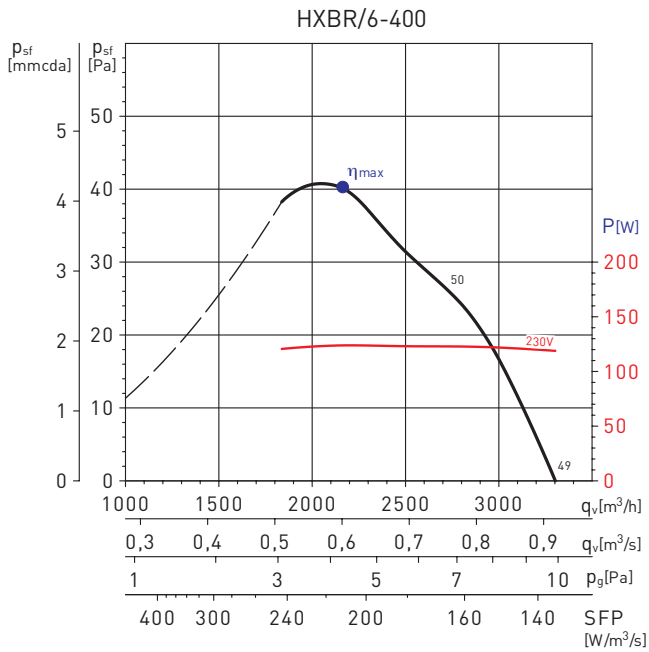

MC	EC	VSD	SR	η [%]	N	[kW]	[m^3/h]	[Pa]	[RPM]
A	Static	No	1	28,3	40,1	0,135	2840	48	908

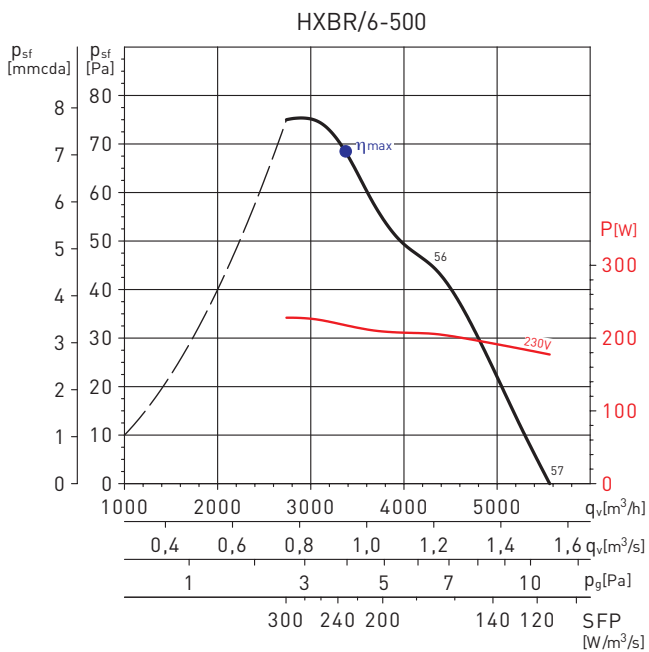

MC	EC	VSD	SR	η [%]	N	[kW]	[m^3/h]	[Pa]	[RPM]
A	Static	No	1	29,5	40,0	0,218	3353	69	886

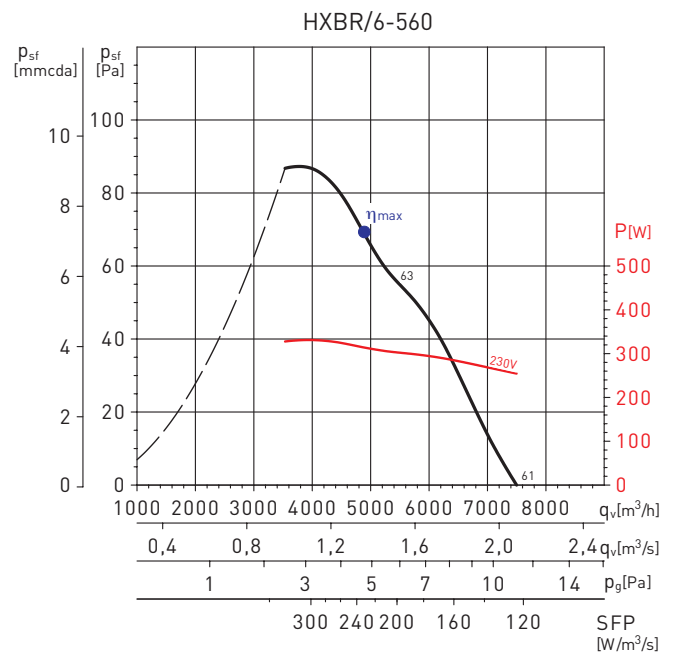

MC	EC	VSD	SR	η [%]	N	[kW]	[m^3/h]	[Pa]	[RPM]
A	Static	No	1	30,6	40,0	0,324	4505	79	884

CURVAS CARACTERÍSTICAS – MOTOR DE 6 POLOS

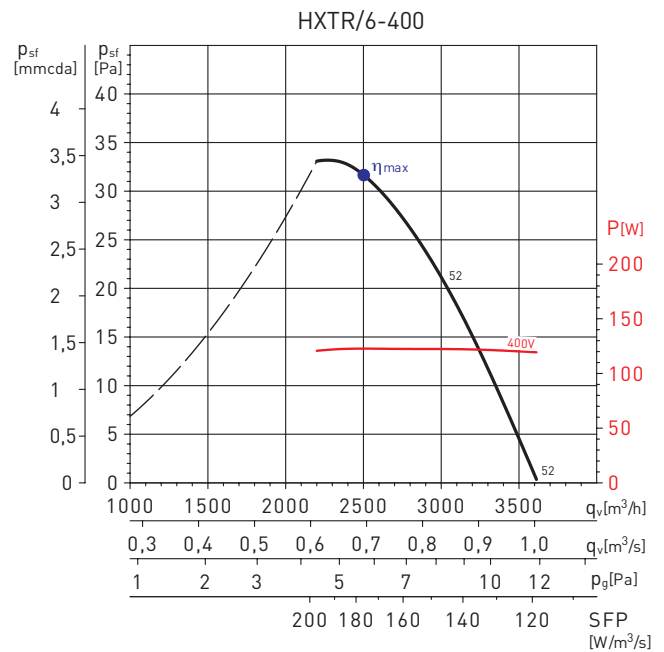
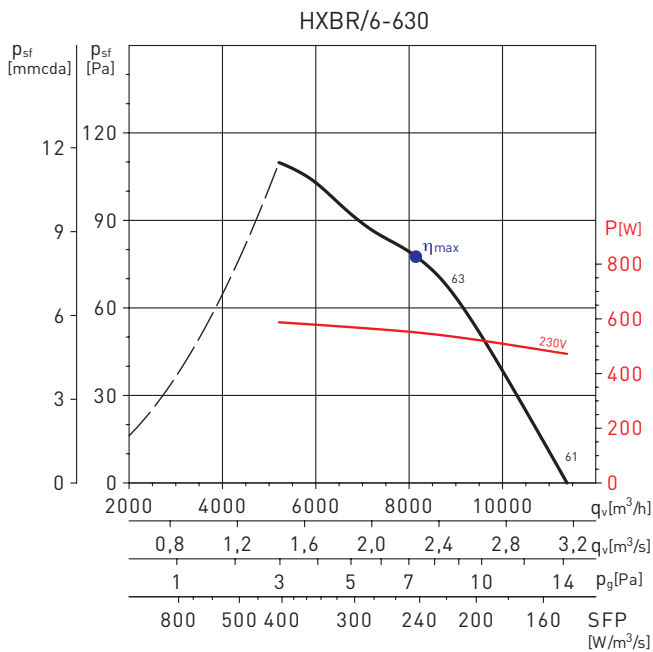

MC	EC	VSD	SR	η [%]	N	[kW]	[m³/h]	[Pa]	[RPM]
A	Static	No	1	32,0	40,0	0,551	8143	78	879

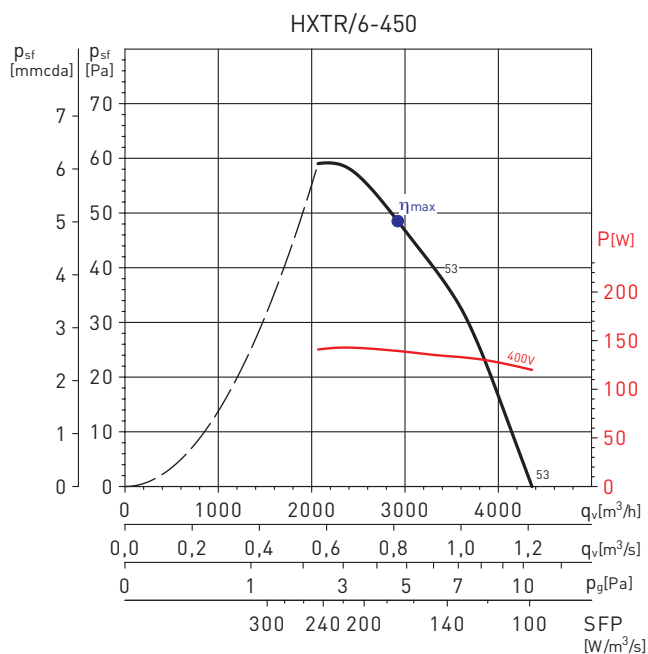

MC	EC	VSD	SR	η [%]	N	[kW]	[m³/h]	[Pa]	[RPM]
A	Static	No	1	28,3	40,0	0,141	2787	52	911

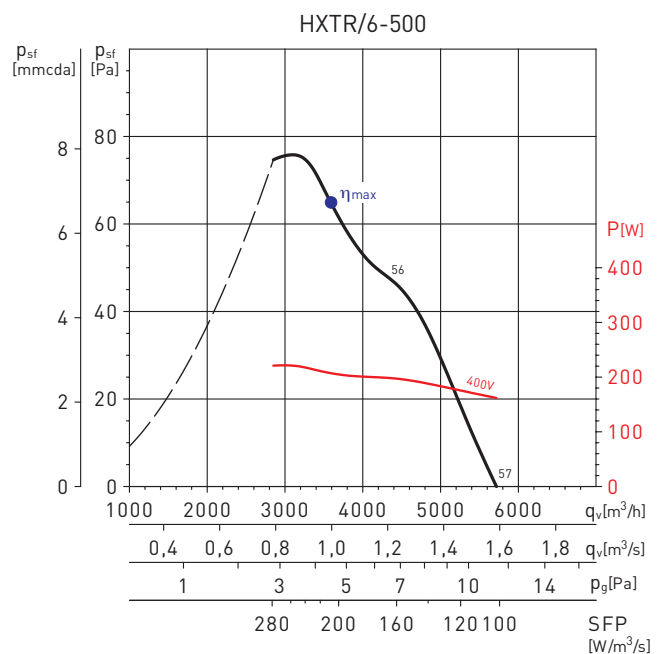

MC	EC	VSD	SR	η [%]	N	[kW]	[m³/h]	[Pa]	[RPM]
A	Static	No	1	31,6	42,2	0,211	3473	69	891

CURVAS CARACTERÍSTICAS - MOTOR DE 6 POLOS

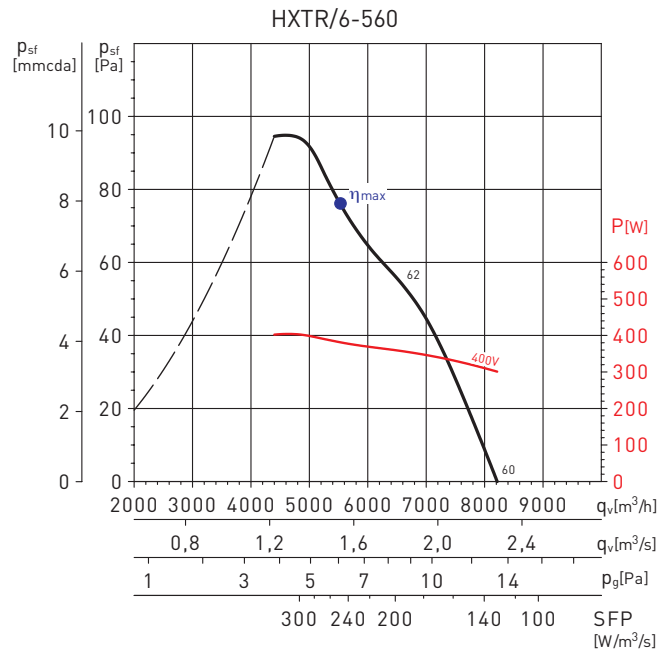

MC	EC	VSD	SR	η[%]	N	[kW]	[m³/h]	[Pa]	[RPM]
A	Static	No	1	31,8	40,7	0,396	5072	89	926

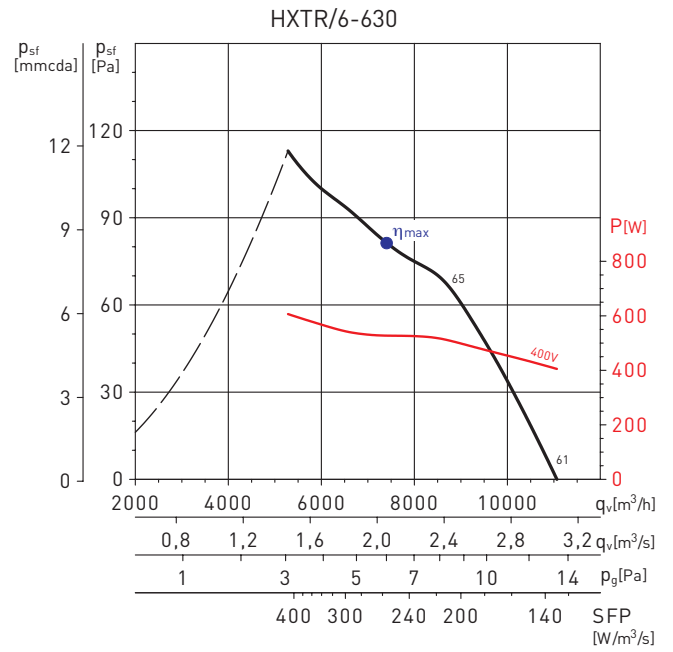

MC	EC	VSD	SR	η[%]	N	[kW]	[m³/h]	[Pa]	[RPM]
A	Static	No	1	32,1	40,2	0,522	8323	72	901

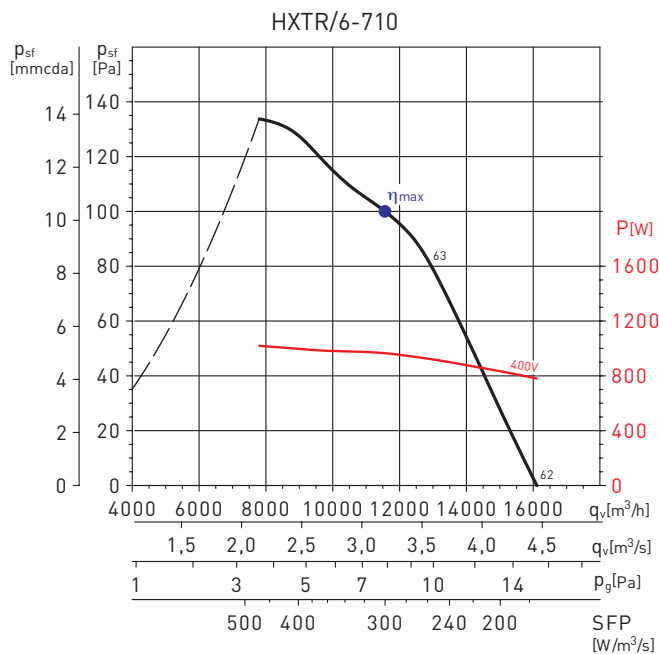

MC	EC	VSD	SR	η[%]	N	[kW]	[m³/h]	[Pa]	[RPM]
A	Static	No	1	33,5	40,0	0,955	11947	96	909

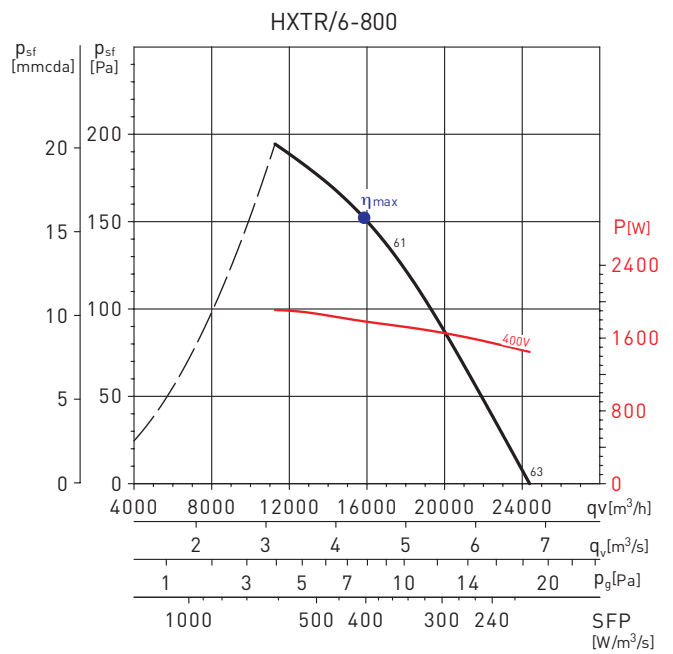

MC	EC	VSD	SR	η[%]	N	[kW]	[m³/h]	[Pa]	[RPM]
A	Static	No	1	37,5	42,2	1,784	15844	152	898

CURVAS CARACTERÍSTICAS – MOTORES DE 8 Y 12 POLOS

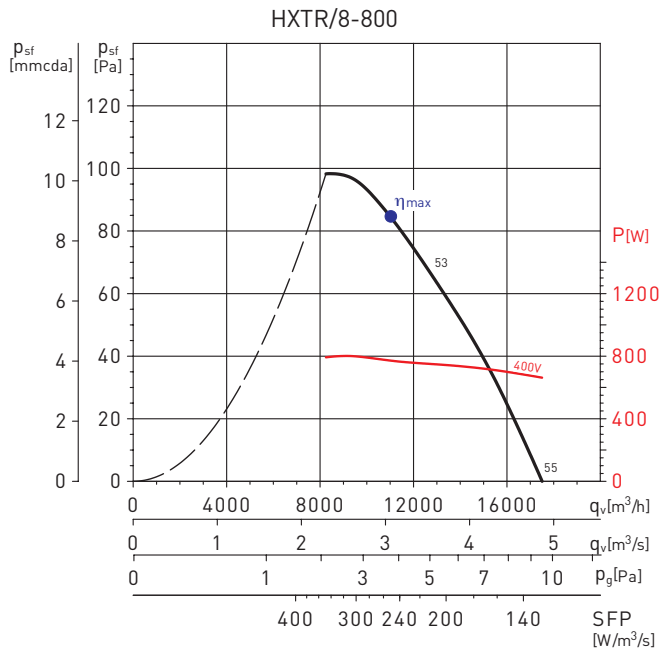

MC	EC	VSD	SR	η[%]	N	[kW]	[m³/h]	[Pa]	[RPM]
A	Static	No	1	33,5	40,5	0,772	10994	85	634

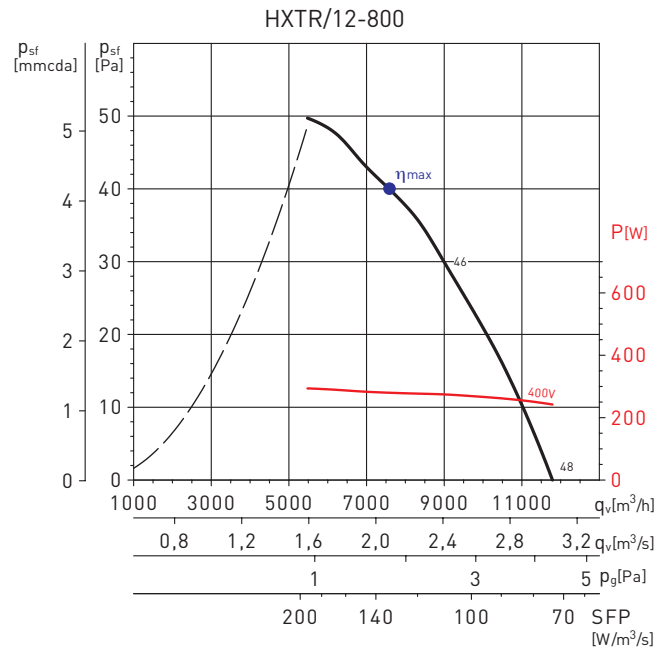

MC	EC	VSD	SR	η[%]	N	[kW]	[m³/h]	[Pa]	[RPM]
A	Static	No	1	30,3	40,1	0,279	7881	39	442

ACCESORIOS DE MONTAJE

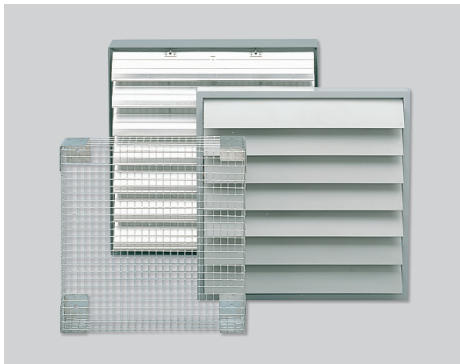

Modelo	Defensas de protección	Persianas de sobrepresión	
		Plástico	Aluminio
250	DEF-250 D	PER-250 W	PER-250 CR
315	DEF-325 D	PER-355 W	PER-355 CR
355	DEF-375 D	PER-355 W	PER-355 CR
400	DEF-450 D	PER-400 W	PER-400 CR
450	DEF-450 D	PER-450 W	PER-450 CR
500	DEF-525 D	PER-500 W	PER-500 CR
560	DEF-630 D	PER-560 W	PER-630 CR
630	DEF-630 D	PER-630 W	PER-630 CR
710	DEF-800 D	PER-710 W	PER-710 CR
800	DEF-800 D	PER-800 W	PER-800 CR

ACCESORIOS ELÉCTRICOS



REB-1N / REB 2,5N
Reguladores electrónicos monofásicos.



REB-5
Reguladores electrónicos monofásicos.



RMB
Monofásicos 230V
RMT
Trifásicos 400V

Reguladores electromecánicos por transformador.



VFTM IP21/IP54
Convertidores de frecuencia para motores trifásicos a 400V.