

Ventiladores centrífugos de tejado, de descarga horizontal, de muy bajo perfil, base de chapa de acero galvanizada, cubierta de aluminio, rodete centrífugo de álabes hacia atrás (de plástico para los modelos 225 y 250, de chapa de aluminio para los modelos 280 a 630), protegido con reja de seguridad antipájaros, motor de rotor exterior, con protector térmico e interruptor paro-marcha.

Motores

De 2, 4, ó 6 polos según versiones.

Tensión de alimentación

Monofásicos 230V-50/60Hz (1), IP54, Clase F, regulables por variación de tensión.

Trifásicos 230/400V-50/60Hz (2), IP54, Clase F.

Modelos trifásicos regulables por convertidor de frecuencia y por variación de tensión (excepto modelos 4-450 y 4-560).

(1) Modelos /4-500 y 6/630, 230V-50Hz.

(2) Modelos /4-450, 4/560 y 6/630, 230/400V-50Hz.



Bajo perfil

Motor de rotor exterior que permite limitar la altura del aparato.



Rodete centrífugo de álabes hacia atrás, de alta eficiencia

Fácil mantenimiento y bajo consumo.



Malla antipájaros

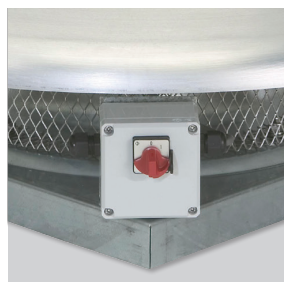

Interruptor paro-marcha incorporado

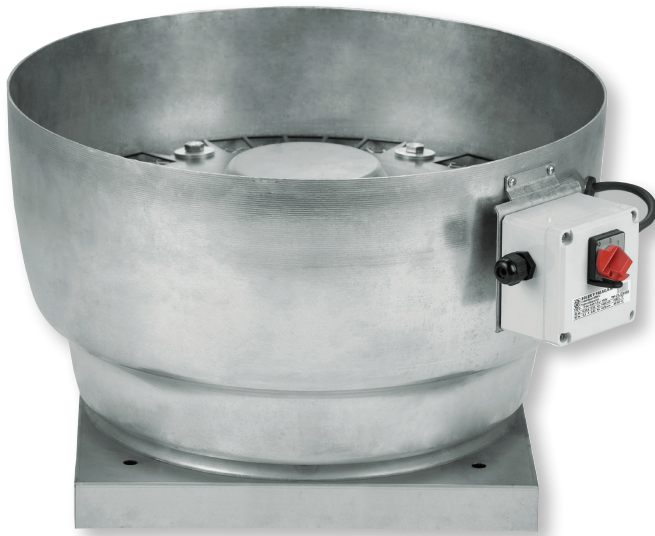

Ventiladores centrífugos de tejado, de descarga vertical, de muy bajo perfil, base de chapa de acero galvanizada, cubierta de aluminio, rodete centrífugo de álabes hacia atrás (de plástico para los modelos 225 y 250, de chapa de aluminio para los modelos 280 a 630), protegido con reja de seguridad antipájaros, motor de rotor exterior, con protector térmico e interruptor paro-marcha.

Motores

De 2, 4, ó 6 polos según versiones.

Tensión de alimentación

Monofásicos 230V-50/60Hz (1), IP54, Clase F, regulables por variación de tensión.

Trifásicos 230/400V-50/60Hz (2), IP54, Clase F.

Modelos trifásicos regulables por convertidor de frecuencia y por variación de tensión (excepto modelos 4-450 y 4-560).

(1) Modelos /4-500 y 6/630, 230V-50Hz.

(2) Modelos /4-450, 4/560 y 6/630, 230/400V-50Hz.



Bajo perfil

Motor de rotor exterior que permite limitar la altura del aparato.



Rodete centrífugo de álabes hacia atrás, de alta eficiencia

Fácil mantenimiento y bajo consumo.



Malla antipájaros

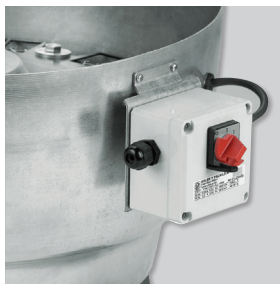

Interruptor paro-marcha incorporado

CARACTERÍSTICAS TÉCNICAS

Es imprescindible comprobar que las características eléctricas (voltaje, intensidad, frecuencia, etc.) del motor que aparecen en la placa del mismo son compatibles con las de la instalación.

Modelo	Velocidad media (r.p.m.)	Potencia absorbida máxima (W)	Intensidad máxima absorbida a 230V** (A)	Caudal máximo (m³/h)	Nivel presión sonora* (dB(A))		Temperatura de trabajo a 50Hz (°C)	Peso (kg)	Regulador de tensión	
					Aspiración	Descarga			REB	RMB
MONOFÁSICOS 2 POLOS										
CRHB/2-225N	2640	160	0,7	1.160	44	50	-40/+70	11	REB-1N	RMB-1,5
CRHB/2-250N	2630	236	1,0(1,1)	1.390	52	58	-40/+70	11,5	REB-2,5N	RMB-1,5
MONOFÁSICOS 4 POLOS										
CRHB/4-225N	1400	41	0,2	600	36	42	-40/+70	10	REB-1N	RMB-1,5
CRHB/4-250N	1320	46	0,2	740	38	44	-40/+70	10,5	REB-1N	RMB-1,5
CRHB/4-280N	1280	101	0,4	1.530	41	47	-40/+70	17	REB-1N	RMB-1,5
CRHB/4-315N	1370	157	0,7(0,8)	2.110	45	52	-40/+70	25,5	REB-1N	RMB-1,5
CRHB/4-355N	1370	302	1,3(1,5)	3.090	50	58	-40/+70	27	REB-2,5N	RMB-3,5
CRHB/4-400N	1380	544	2,3(2,7)	4.540	53	60	-40/+55	30,5	REB-5	RMB-3,5
CRHB/4-450N	1410	925	3,8(5,5)	6.310	60	68	-40/+70	42	REB-10	RMB-8
CRHB/4-500N	1410	1.588	6,6(9,1)	8.770	63	71	-40/+40	60	REB-10	RMB-10
MONOFÁSICOS 6 POLOS										
CRHB/6-315N	880	60	0,3	1.420	36	44	-40/+70	24	REB-1N	RMB-1,5
CRHB/6-355N	890	116	0,6	2.130	38	45	-40/+70	24,5	REB-1N	RMB-1,5
CRHB/6-400N	910	171	0,7	2.950	45	51	-40/+70	30,5	REB-1N	RMB-1,5
CRHB/6-450N	900	306	1,3	4.220	49	56	-40/+60	32	REB-2,5N	RMB-1,5
CRHB/6-500N	910	445	1,9(2,5)	5.930	51	58	-40/+70	47	REB-2,5N	RMB-3,5
CRHB/6-560N	930	917	4,4(5,1)	9.350	56	64	-40/+70	60	REB-10	RMB-8
CRHB/6-630N	890	1.533	5,7(7,1)	13.240	59	67	-40/+50	68	REB-10	RMB-8

* Nivel de presión acústica medido a 3 m, en propagación semiesférica, en el punto de trabajo 2 de la curva de rendimiento.

** Corriente máxima cuando la velocidad está controlada por la tensión.

Modelo	Velocidad media (r.p.m.)	Potencia absorbida máxima (W)	Intensidad máxima absorbida** (A)		Caudal máximo (m³/h)	Nivel presión sonora* (dB(A))		Temperatura de trabajo a 50Hz (°C)	Peso (kg)	Convertidor de frecuencia	
			230V	400V		Aspiración	Descarga			VFTM	
										1-230V	3-400V
TRIFÁSICOS 4 POLOS											
CRHT/4-315N	1370	162	0,7	0,4	2.200	44	51	-40/+70	24,5	0,18	0,37
CRHT/4-355N	1390	305	1,2	0,7	3.190	44	51	-40/+65	26	0,18	0,37
CRHT/4-400N	1370	517	1,9	1,1	4.630	54	60	-40/+70	29,5	0,37	0,37
CRHT/4-450N	1400	893	3,3	1,9	6.180	58	66	-40/+60	40	0,55	0,75
CRHT/4-500N	1420	1.552	5,4	3,1	8.680	64	71	-40/+70	53	1,1	1,5
CRHT/4-560N	1350	2.619	7,8	4,5	13.220	66	75	-40/+60	64,5	1,5	2,2
TRIFÁSICOS 6 POLOS											
CRHT/6-315N	920	67	0,3	0,2	1.450	35	43	-40/+70	24,5	0,18	0,37
CRHT/6-355N	900	119	0,5	0,3	2.140	38	49	-40/+70	25	0,18	0,37
CRHT/6-400N	910	155	0,5	0,3	2.940	45	51	-40/+70	29	0,18	0,37
CRHT/6-450N	890	269	0,9	0,5	4.080	47	53	-40/+70	29,5	0,18	0,37
CRHT/6-500N	910	500	1,7	1,0	6.030	49	57	-40/+70	40	0,37	0,37
CRHT/6-560N	930	889	3,5	2,0	9.420	55	64	-40/+70	58	0,75	0,75
CRHT/6-630N	910	1.519	6,3	3,6	13.400	58	66	-40/+55	65	1,1	1,5

* Nivel de presión acústica medido a 3 m, en propagación semiesférica, en el punto de trabajo 2 de la curva de rendimiento.

** A 50Hz sin convertidor de frecuencia.

DIMENSIONES CRHB-N/CRHT-N

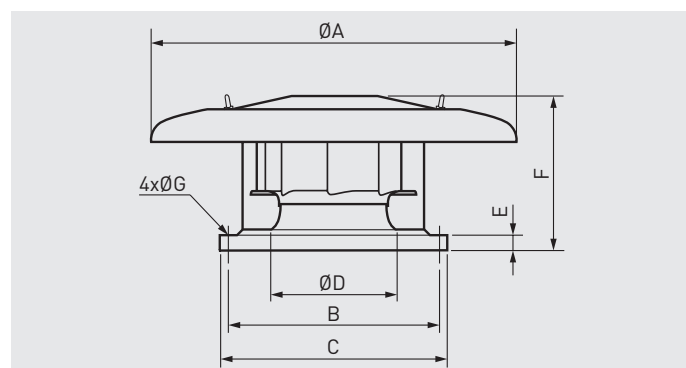

Modelo	ØA	B	C	ØD	E	F	ØG
225N	570	245	326	183	35	209	10
250N	570	245	326	204	35	209	10
280N	640	330	435	228	40	273,5	12
315N	895	450	560	257	40	324	12
355N	895	450	560	289	40	349	12
400N	1150	535	630	326	40	363	12
450N	1150	535	630	367	40	409/397*	12
500N	1150	590	710	407	40	435/424*	14
560N	1150	750	900	455	40	486	14
630N	1150	750	900	513	40	548	14

* 4p / 6p

CARACTERÍSTICAS TÉCNICAS

Es imprescindible comprobar que las características eléctricas (voltaje, intensidad, frecuencia, etc.) del motor que aparecen en la placa del mismo son compatibles con las de la instalación.

Modelo	Velocidad media (r.p.m.)	Potencia absorbida máxima (W)	Intensidad máxima absorbida a 230V** (A)	Caudal máximo (m³/h)	Nivel presión sonora* (dB(A))		Temperatura de trabajo a 50Hz (°C)	Peso (kg)	Regulador de tensión	
					Aspiración	Descarga			REB	RMB
MONOFÁSICOS 2 POLOS										
CRVB/2-225N	2660	157	0,7	1.080	49	54	-40/+70	11	REB-1N	RMB-1,5
CRVB/2-250N	2640	231	1,0(1,1)	1.320	52	58	-40/+70	11,5	REB-2,5N	RMB-1,5
MONOFÁSICOS 4 POLOS										
CRVB/4-225N	1410	41	0,2	570	36	40	-40/+70	10	REB-1N	RMB-1,5
CRVB/4-250N	1370	46	0,2	690	38	44	-40/+70	10,5	REB-1N	RMB-1,5
CRVB/4-280N	1280	99	0,4	1.350	43	48	-40/+70	17,5	REB-1N	RMB-1,5
CRVB/4-315N	1380	156	0,7(0,8)	2.050	48	53	-40/+70	27	REB-1N	RMB-1,5
CRVB/4-355N	1370	296	1,2	2.960	51	57	-40/+70	29,5	REB-2,5N	RMB-1,5
CRVB/4-400N	1380	570	2,4(2,8)	4.530	55	59	-40/+55	29	REB-5	RMB-3,5
CRVB/4-450N	1410	904	3,7(5,6)	6.280	61	65	-40/+70	40,5	REB-10	RMB-8
CRVB/4-500N	1410	1.587	6,5(9,1)	8.550	63	67	-40/+40	61,5	REB-10	RMB-10
MONOFÁSICOS 6 POLOS										
CRVB/6-315N	880	60	0,3	1.380	36	43	-40/+50	25,5	REB-1N	RMB-1,5
CRVB/6-355N	890	116	0,6	2.030	39	45	-40/+50	26,5	REB-1N	RMB-1,5
CRVB/6-400N	910	166	0,7	2.900	46	48	-40/+70	27,5	REB-1N	RMB-1,5
CRVB/6-450N	890	310	1,3	4.070	49	53	-40/+60	30	REB-2,5N	RMB-1,5
CRVB/6-500N	910	444	1,9(2,4)	5.750	51	56	-40/+70	48,5	REB-2,5N	RMB-3,5
CRVB/6-560N	930	930	4,4(5,1)	8.920	56	61	-40/+70	65	REB-10	RMB-8
CRVB/6-630N	900	1.550	6,6(6,9)	12.410	58	65	-40/+50	73	REB-10	RMB-8

* Nivel de presión acústica medido a 3 m, en propagación semiesférica, en el punto de trabajo 2 de la curva de rendimiento.

** Corriente máxima cuando la velocidad está controlada por la tensión.

Modelo	Velocidad media (r.p.m.)	Potencia absorbida máxima (W)	Intensidad máxima absorbida** (A)		Caudal máximo (m³/h)	Nivel presión sonora* (dB(A))		Temperatura de trabajo a 50Hz (°C)	Peso (kg)	Convertidor de frecuencia	
			230V	400V		Aspiración	Descarga			VFTM	
										1-230V	3-400V
TRIFÁSICOS 4 POLOS											
CRVT/4-315N	1370	160	0,7	0,4	2.130	46	51	-40/+70	26	0,18	0,37
CRVT/4-355N	1390	296	1,2	0,7	3.030	47	53	-40/+65	27	0,18	0,37
CRVT/4-400N	1380	504	1,9	1,1	4.540	54	58	-40/+70	28	0,37	0,37
CRVT/4-450N	1390	900	3,1	1,8	6.080	58	63	-40/+70	38,5	0,55	0,75
CRVT/4-500N	1420	1.588	5,4	3,1	8.530	64	68	-40/+70	54,5	1,1	1,5
CRVT/4-560N	1350	2.639	8,0	4,6	12.710	65	71	-40/+60	70	1,5	2,2
TRIFÁSICOS 6 POLOS											
CRVT/6-315N	920	66	0,3	0,2	1.410	36	43	-40/+70	26	0,18	0,37
CRVT/6-355N	900	118	0,5	0,3	2.080	39	54	-40/+70	27	0,18	0,37
CRVT/6-400N	920	153	0,5	0,3	2.830	44	49	-40/+70	27,5	0,18	0,37
CRVT/6-450N	890	267	0,9	0,5	3.800	48	51	-40/+70	28	0,18	0,37
CRVT/6-500N	920	498	1,9	1,1	5.940	50	55	-40/+70	41	0,37	0,37
CRVT/6-560N	930	882	3,5	2,0	9.010	57	60	-40/+70	63,5	0,75	0,75
CRVT/6-630N	900	1.521	6,4	3,7	12.550	58	64	-40/+55	70	1,1	1,5

* Nivel de presión acústica medido a 3 m, en propagación semiesférica, en el punto de trabajo 2 de la curva de rendimiento.

** A 50Hz sin convertidor de frecuencia.

DIMENSIONES CRVB-N/CRVT-N

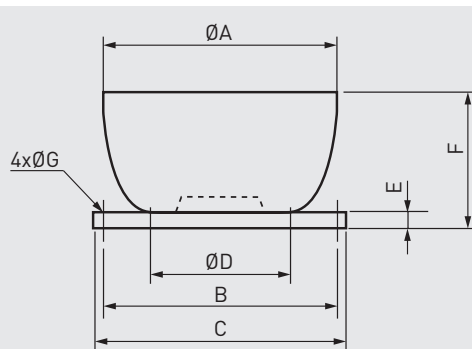

Modelo	ØA	B	C	ØD	E	F	ØG
225N	434	245	326	183	35	260	10
250N	434	245	326	204	35	260	10
280N	560	330	435	228	40	335	12
315N	754	450	560	257	40	395	12
355N	754	450	560	289	40	395	12
400N	857	535	630	326	40	459	12
450N	857	535	630	367	40	459	12
500N	950	590	710	407	40	530	14
560N	1216	750	900	455	40	580	14
630N	1216	750	900	513	40	580	14

CURVAS CARACTERÍSTICAS - CARACTERÍSTICAS ACÚSTICAS CRHB 2 Polos

- q_v = Caudal en m^3/h .
- p_{sf} = Presión estática en mmcda y Pa.
- Potencia absorbida en W.
- SFP curvas azules en $W/m^3/s$.
- Aire seco normal a $20^\circ C$ y 760 mmHg.
- Ensayos realizados de acuerdo a Norma ISO 5801 y AMCA 210-99.

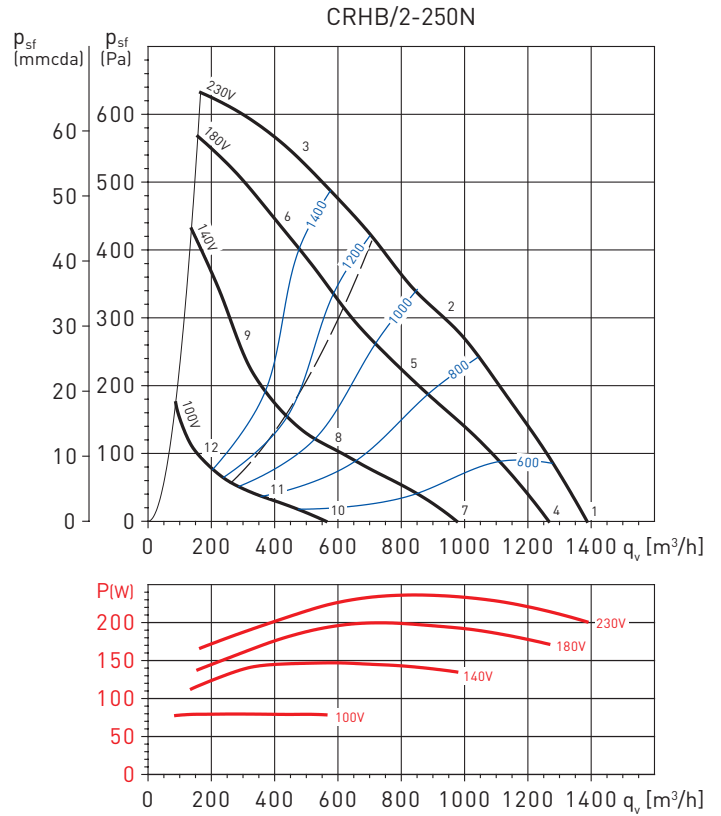
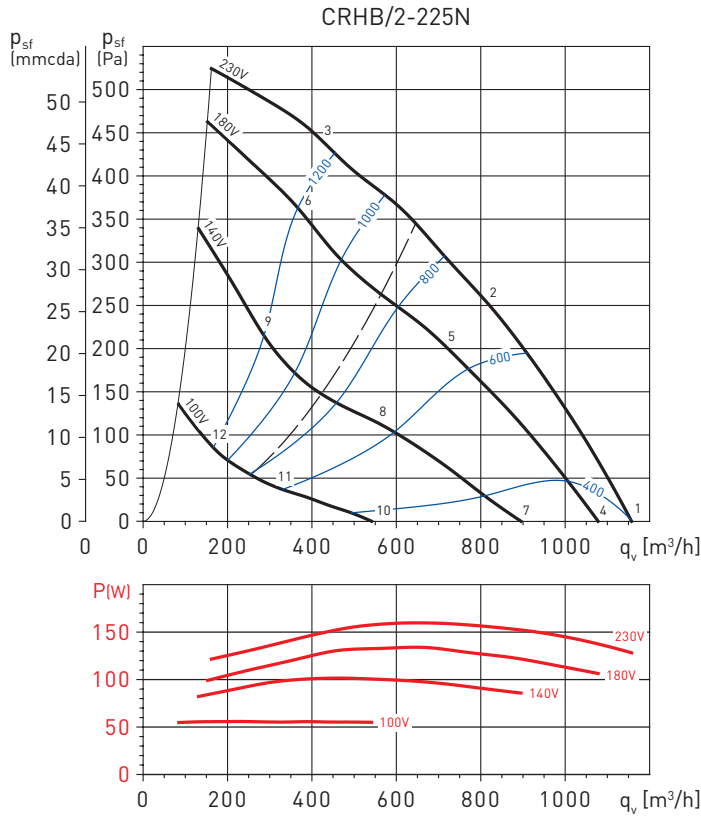

Punto de trabajo		63	125	250	500	1.000	2.000	4.000	8.000	LwA
1	Aspiración	39	50	61	68	71	69	69	67	76
	Descarga	40	50	63	71	77	76	72	70	81
2	Aspiración	34	43	56	59	61	60	62	56	67
	Descarga	38	44	60	62	69	68	64	59	73
3	Aspiración	38	49	62	64	62	62	61	55	70
	Descarga	40	50	64	67	70	70	65	59	75
4	Aspiración	37	48	59	66	69	67	67	65	75
	Descarga	38	48	61	69	75	74	70	68	80
5	Aspiración	31	40	53	56	58	57	59	53	65
	Descarga	35	41	57	59	66	65	61	56	70
6	Aspiración	36	47	60	62	60	60	59	53	67
	Descarga	38	48	62	65	68	68	63	57	73
7	Aspiración	34	45	56	63	66	64	64	62	71
	Descarga	35	45	58	66	72	71	67	65	76
8	Aspiración	25	34	47	50	52	51	53	47	59
	Descarga	29	35	51	53	60	59	55	50	65
9	Aspiración	30	41	54	56	54	54	53	47	62
	Descarga	32	42	56	59	62	62	57	51	67
10	Aspiración	23	34	45	52	55	53	53	51	60
	Descarga	24	34	47	55	61	60	56	54	65
11	Aspiración	14	23	36	39	41	40	42	36	48
	Descarga	18	24	40	42	49	48	44	39	53
12	Aspiración	20	31	44	46	44	44	43	37	51
	Descarga	22	32	46	49	52	52	47	41	57

Punto de trabajo		63	125	250	500	1.000	2.000	4.000	8.000	LwA
1	Aspiración	37	49	65	68	69	68	71	66	76
	Descarga	40	50	68	72	76	76	74	69	81
2	Aspiración	32	45	59	62	64	62	62	58	69
	Descarga	33	44	64	66	70	70	66	61	75
3	Aspiración	37	49	60	64	67	66	64	59	72
	Descarga	39	50	64	68	74	74	69	63	78
4	Aspiración	35	47	63	66	67	66	69	64	74
	Descarga	38	48	66	70	74	74	72	67	79
5	Aspiración	29	42	56	59	61	59	59	55	66
	Descarga	30	41	61	63	67	67	63	58	72
6	Aspiración	35	47	58	62	65	64	62	57	70
	Descarga	37	48	62	66	72	72	67	61	76
7	Aspiración	29	41	57	60	61	60	63	58	68
	Descarga	32	42	60	64	68	68	66	61	74
8	Aspiración	21	34	48	51	53	51	51	47	59
	Descarga	22	33	53	55	59	59	55	50	64
9	Aspiración	29	41	52	56	59	58	56	51	64
	Descarga	31	42	56	60	66	66	61	55	70
10	Aspiración	18	30	46	49	50	49	52	47	57
	Descarga	21	31	49	53	57	57	55	50	62
11	Aspiración	10	23	37	40	42	40	40	36	48
	Descarga	11	22	42	44	48	48	44	39	53
12	Aspiración	17	29	40	44	47	46	44	39	52
	Descarga	19	30	44	48	54	54	49	43	59

CURVAS CARACTERÍSTICAS - CARACTERÍSTICAS ACÚSTICAS CRHB 4 Polos

- q_v = Caudal en m^3/h .
- p_{sf} = Presión estática en mmcda y Pa.
- Potencia absorbida en W.
- SFP curvas azules en $W/m^3/s$.
- Aire seco normal a $20^\circ C$ y 760 mmHg.
- Ensayos realizados de acuerdo a Norma ISO 5801 y AMCA 210-99.

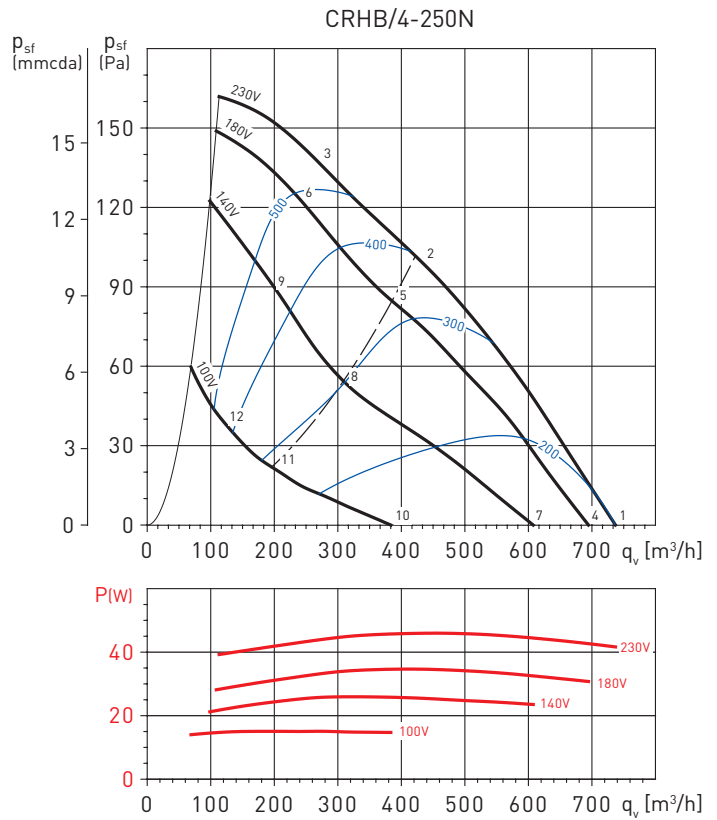
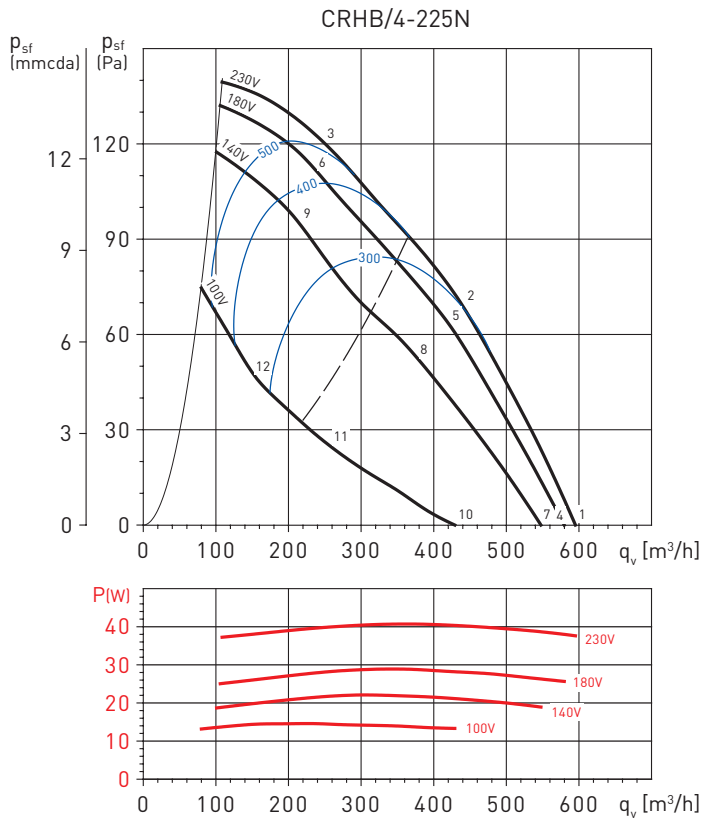

Punto de trabajo		63	125	250	500	1.000	2.000	4.000	8.000	LwA
1	Aspiración	25	43	45	53	55	58	50	38	61
	Descarga	26	44	48	56	61	63	52	40	66
2	Aspiración	20	43	41	46	46	51	45	35	54
	Descarga	20	41	43	51	54	56	44	36	59
3	Aspiración	22	43	42	46	46	46	42	33	52
	Descarga	23	42	45	51	56	54	43	35	59
4	Aspiración	24	42	44	52	54	57	49	37	61
	Descarga	25	43	47	55	60	62	51	39	65
5	Aspiración	19	42	40	45	45	50	44	34	53
	Descarga	19	40	42	50	53	55	43	35	58
6	Aspiración	21	42	41	45	45	45	41	32	52
	Descarga	22	41	44	50	55	53	42	34	58
7	Aspiración	23	41	43	51	53	56	48	36	59
	Descarga	24	42	46	54	59	61	50	38	64
8	Aspiración	17	40	38	43	43	48	42	32	51
	Descarga	17	38	40	48	51	53	41	33	56
9	Aspiración	19	40	39	43	43	43	39	30	50
	Descarga	20	39	42	48	53	51	40	32	57
10	Aspiración	18	36	38	46	48	51	43	31	54
	Descarga	19	37	41	49	54	56	45	33	59
11	Aspiración	9	32	30	35	35	40	34	24	43
	Descarga	9	30	32	40	43	45	33	25	48
12	Aspiración	12	33	32	36	36	36	32	23	42
	Descarga	13	32	35	41	46	44	33	25	49

Punto de trabajo		63	125	250	500	1.000	2.000	4.000	8.000	LwA
1	Aspiración	29	45	45	52	52	59	49	39	61
	Descarga	27	46	48	56	61	64	51	42	66
2	Aspiración	24	43	40	47	46	48	44	35	53
	Descarga	27	43	44	56	56	56	46	37	61
3	Aspiración	26	44	42	49	48	47	44	36	54
	Descarga	25	43	44	54	58	55	47	38	61
4	Aspiración	28	44	44	51	51	58	48	38	60
	Descarga	26	45	47	55	60	63	50	41	66
5	Aspiración	23	42	39	46	45	47	43	34	52
	Descarga	26	42	43	55	55	55	45	36	60
6	Aspiración	25	43	41	48	47	46	43	35	54
	Descarga	24	42	43	53	57	54	46	37	60
7	Aspiración	25	41	41	48	48	55	45	35	57
	Descarga	23	42	44	52	57	60	47	38	63
8	Aspiración	18	37	34	41	40	42	38	29	48
	Descarga	21	37	38	50	50	50	40	31	55
9	Aspiración	21	39	37	44	43	42	39	31	50
	Descarga	20	38	39	49	53	50	42	33	57
10	Aspiración	16	32	32	39	39	46	36	26	48
	Descarga	14	33	35	43	48	51	38	29	53
11	Aspiración	8	27	24	31	30	32	28	19	38
	Descarga	11	27	28	40	40	40	30	21	46
12	Aspiración	12	30	28	35	34	33	30	22	40
	Descarga	11	29	30	40	44	41	33	24	47

CURVAS CARACTERÍSTICAS - CARACTERÍSTICAS ACÚSTICAS CRHB 4 Polos

- q_v = Caudal en m^3/h .
- p_{sf} = Presión estática en mmcda y Pa.
- Potencia absorbida en W.
- SFP curvas azules en $W/m^3/s$.
- Aire seco normal a $20^\circ C$ y 760 mmHg.
- Ensayos realizados de acuerdo a Norma ISO 5801 y AMCA 210-99.

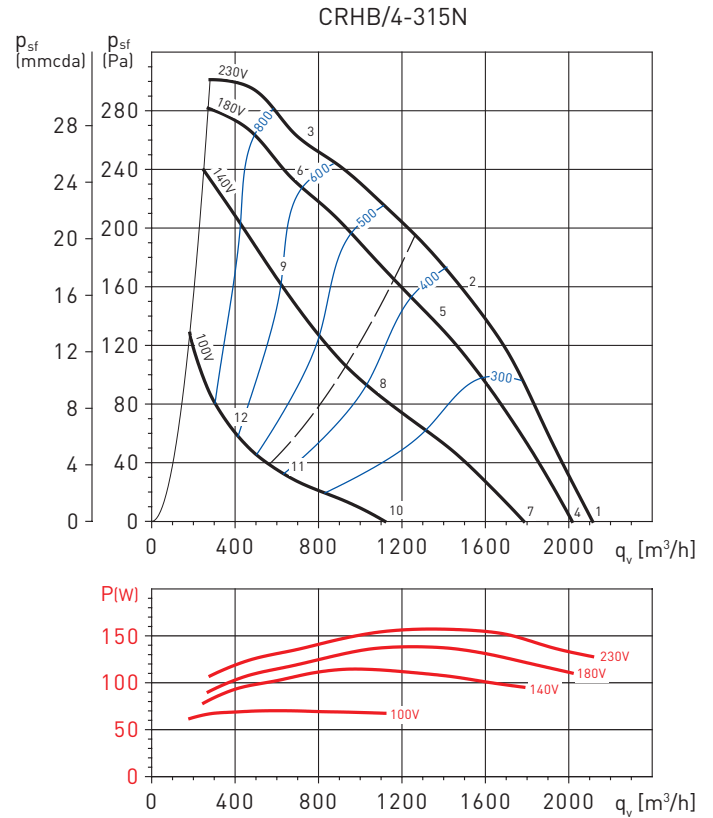
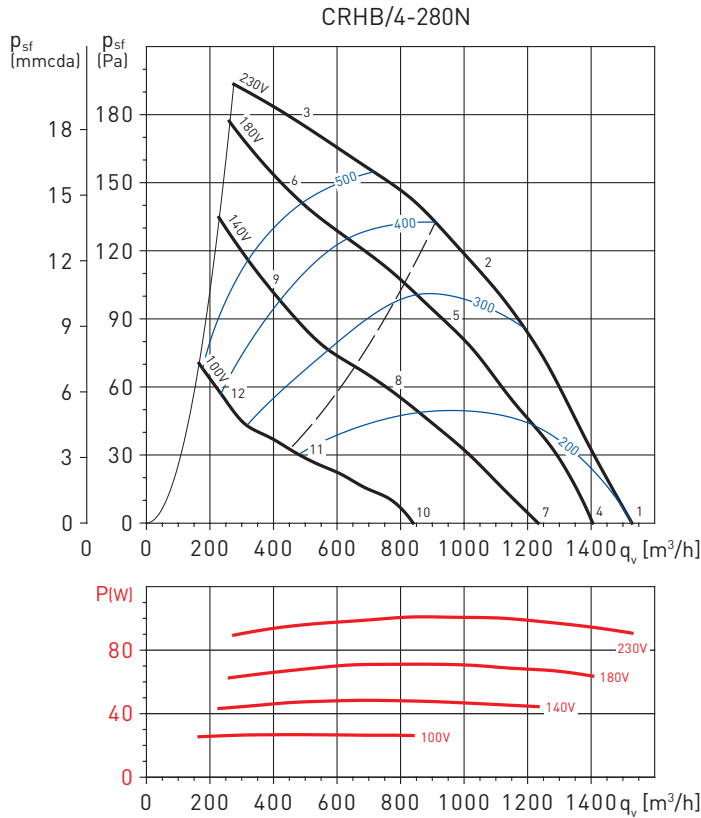

Punto de trabajo		63	125	250	500	1.000	2.000	4.000	8.000	LwA
1	Aspiración	35	48	53	58	54	58	55	40	63
	Descarga	36	55	56	60	64	65	60	46	69
2	Aspiración	30	43	49	56	50	51	47	37	59
	Descarga	32	50	51	58	61	58	51	41	65
3	Aspiración	39	48	52	60	52	50	44	36	62
	Descarga	40	50	53	59	63	59	53	44	66
4	Aspiración	33	46	51	56	52	56	53	38	62
	Descarga	34	53	54	58	62	63	58	44	68
5	Aspiración	28	41	47	54	48	49	45	35	56
	Descarga	30	48	49	56	59	56	49	39	62
6	Aspiración	37	46	50	58	50	48	42	34	60
	Descarga	38	48	51	57	61	57	51	42	64
7	Aspiración	30	43	48	53	49	53	50	35	59
	Descarga	31	50	51	55	59	60	55	41	65
8	Aspiración	23	36	42	49	43	44	40	30	52
	Descarga	25	43	44	51	54	51	44	34	58
9	Aspiración	33	42	46	54	46	44	38	30	56
	Descarga	34	44	47	53	57	53	47	38	60
10	Aspiración	23	36	41	46	42	46	43	28	51
	Descarga	24	43	44	48	52	53	48	34	57
11	Aspiración	15	28	34	41	35	36	32	22	44
	Descarga	17	35	36	43	46	43	36	26	50
12	Aspiración	26	35	39	47	39	37	31	23	48
	Descarga	27	37	40	46	50	46	40	31	53

Punto de trabajo		63	125	250	500	1.000	2.000	4.000	8.000	LwA
1	Aspiración	42	54	61	61	61	60	62	48	68
	Descarga	43	59	63	69	71	68	66	54	75
2	Aspiración	35	49	54	55	56	56	51	42	62
	Descarga	36	56	58	63	66	63	56	47	70
3	Aspiración	41	54	57	56	56	54	48	40	63
	Descarga	42	55	58	63	67	64	57	49	70
4	Aspiración	41	53	60	60	60	59	61	47	67
	Descarga	42	58	62	68	70	67	65	53	74
5	Aspiración	33	47	52	53	54	54	49	40	60
	Descarga	34	54	56	61	64	61	54	45	68
6	Aspiración	40	53	56	55	55	53	47	39	61
	Descarga	41	54	57	62	66	63	56	48	69
7	Aspiración	38	50	57	57	57	56	58	44	64
	Descarga	39	55	59	65	67	64	62	50	72
8	Aspiración	28	42	47	48	49	49	44	35	55
	Descarga	29	49	51	56	59	56	49	40	63
9	Aspiración	36	49	52	51	51	49	43	35	58
	Descarga	37	50	53	58	62	59	52	44	65
10	Aspiración	28	40	47	47	47	46	48	34	54
	Descarga	29	45	49	55	57	54	52	40	61
11	Aspiración	17	31	36	37	38	38	33	24	44
	Descarga	18	38	40	45	48	45	38	29	52
12	Aspiración	26	39	42	41	41	39	33	25	47
	Descarga	27	40	43	48	52	49	42	34	55

CURVAS CARACTERÍSTICAS - CARACTERÍSTICAS ACÚSTICAS CRHB 4 Polos

- q_v = Caudal en m^3/h .
- p_{sf} = Presión estática en mmca y Pa.
- Potencia absorbida en W.
- SFP curvas azules en $W/m^3/s$.
- Aire seco normal a $20^\circ C$ y 760 mmHg.
- Ensayos realizados de acuerdo a Norma ISO 5801 y AMCA 210-99.

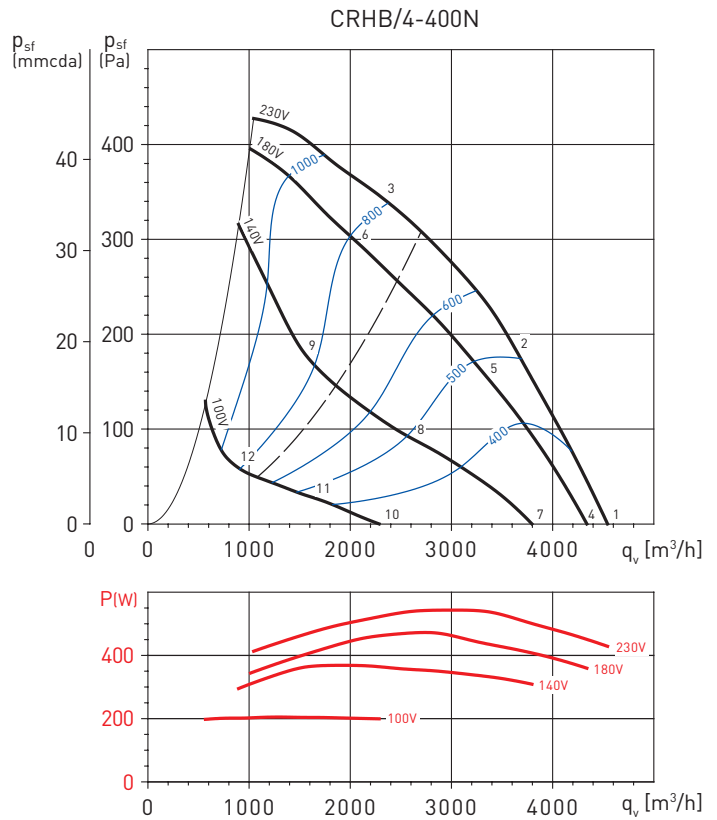
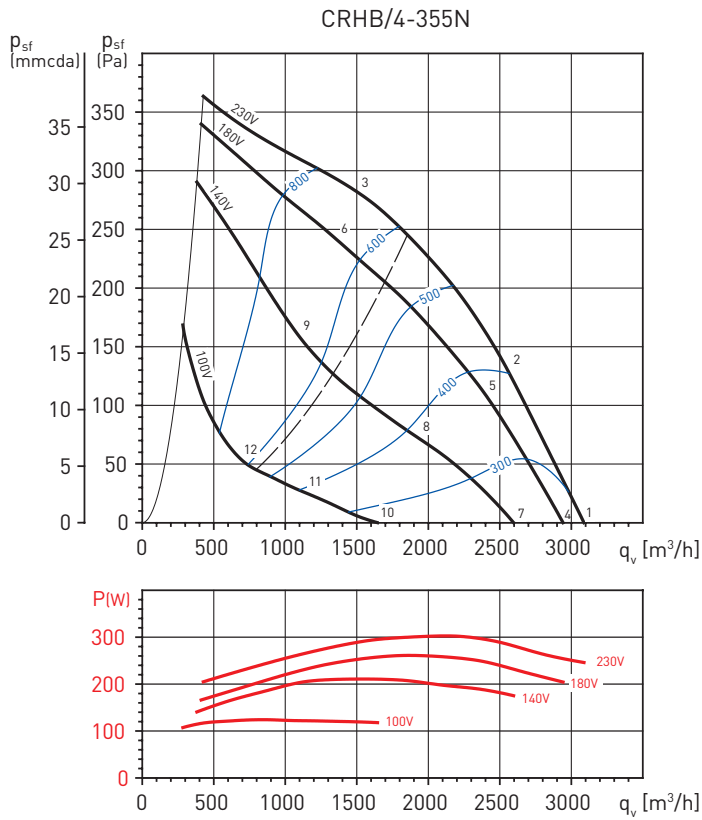

Punto de trabajo		63	125	250	500	1.000	2.000	4.000	8.000	LwA
1	Aspiración	47	59	66	64	65	63	62	55	72
	Descarga	48	63	67	73	76	72	69	60	80
2	Aspiración	43	54	61	59	61	61	58	50	67
	Descarga	43	59	62	69	72	69	66	56	76
3	Aspiración	38	50	56	56	60	59	55	47	65
	Descarga	40	57	60	67	71	69	63	54	75
4	Aspiración	46	58	65	63	64	62	61	54	70
	Descarga	47	62	66	72	75	71	68	59	79
5	Aspiración	41	52	59	57	59	59	56	48	66
	Descarga	41	57	60	67	70	67	64	54	74
6	Aspiración	36	48	54	54	58	57	53	45	63
	Descarga	38	55	58	65	69	67	61	52	73
7	Aspiración	43	55	62	60	61	59	58	51	68
	Descarga	44	59	63	69	72	68	65	56	76
8	Aspiración	37	48	55	53	55	55	52	44	61
	Descarga	37	53	56	63	66	63	60	50	70
9	Aspiración	32	44	50	50	54	53	49	41	59
	Descarga	34	51	54	61	65	63	57	48	68
10	Aspiración	33	45	52	50	51	49	48	41	58
	Descarga	34	49	53	59	62	58	55	46	66
11	Aspiración	25	36	43	41	43	43	40	32	50
	Descarga	25	41	44	51	54	51	48	38	58
12	Aspiración	21	33	39	39	43	42	38	30	48
	Descarga	23	40	43	50	54	52	46	37	57

Punto de trabajo		63	125	250	500	1.000	2.000	4.000	8.000	LwA
1	Aspiración	41	60	66	68	68	68	67	56	75
	Descarga	45	65	69	76	78	75	72	61	82
2	Aspiración	39	57	61	63	64	65	61	51	70
	Descarga	41	61	65	71	74	71	65	57	78
3	Aspiración	39	51	58	60	62	60	55	48	67
	Descarga	40	56	62	66	70	68	64	56	74
4	Aspiración	40	59	65	67	67	67	66	55	74
	Descarga	44	64	68	75	77	74	71	60	81
5	Aspiración	37	55	59	61	62	63	59	49	69
	Descarga	39	59	63	69	72	69	63	55	76
6	Aspiración	37	49	56	58	60	58	53	46	65
	Descarga	38	54	60	64	68	66	62	54	72
7	Aspiración	37	56	62	64	64	64	63	52	71
	Descarga	41	61	65	72	74	71	68	57	78
8	Aspiración	32	50	54	56	57	58	54	44	63
	Descarga	34	54	58	64	67	64	58	50	71
9	Aspiración	32	44	51	53	55	53	48	41	59
	Descarga	33	49	55	59	63	61	57	49	67
10	Aspiración	26	45	51	53	53	53	52	41	60
	Descarga	30	50	54	61	63	60	57	46	67
11	Aspiración	21	39	43	45	46	47	43	33	52
	Descarga	23	43	47	53	56	53	47	39	59
12	Aspiración	20	32	39	41	43	41	36	29	48
	Descarga	21	37	43	47	51	49	45	37	55

CURVAS CARACTERÍSTICAS - CARACTERÍSTICAS ACÚSTICAS CRHB 4 Polos

- q_v = Caudal en m^3/h .
- p_{sf} = Presión estática en mmcda y Pa.
- Potencia absorbida en W.
- SFP curvas azules en $W/m^3/s$.
- Aire seco normal a $20^\circ C$ y 760 mmHg.
- Ensayos realizados de acuerdo a Norma ISO 5801 y AMCA 210-99.

CRHB/4-450N

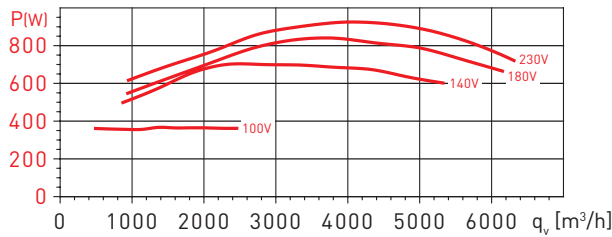
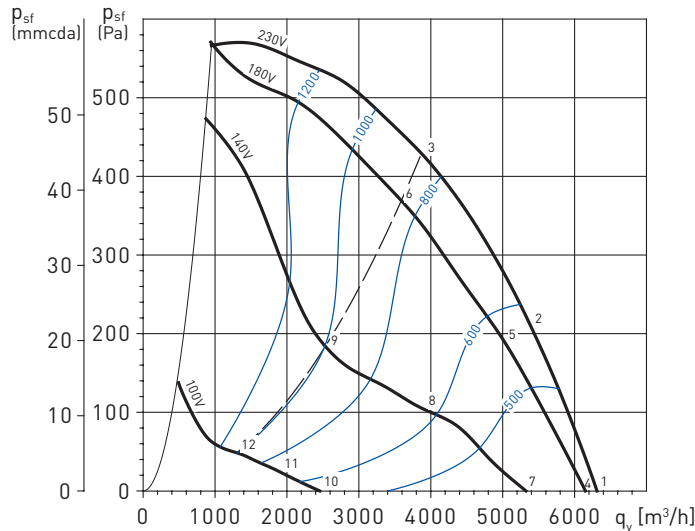

CRHB/4-500N

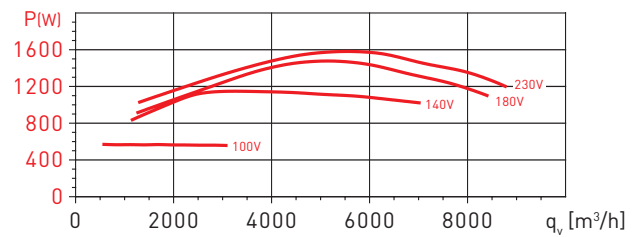
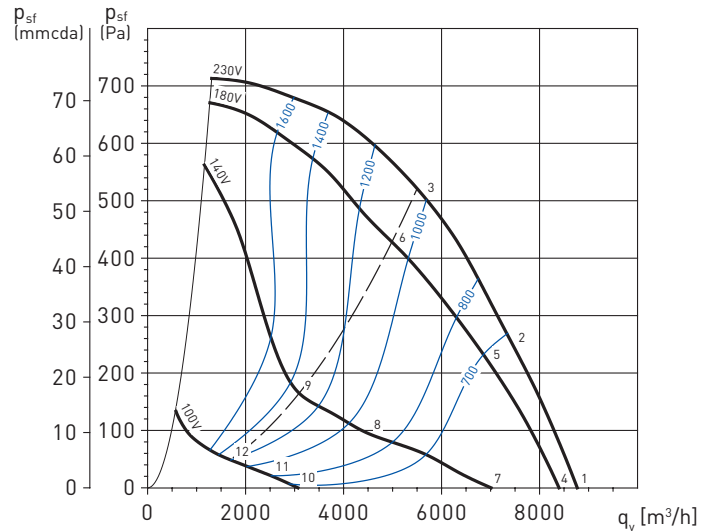

Punto de trabajo		63	125	250	500	1.000	2.000	4.000	8.000	LwA
1	Aspiración	50	67	74	76	74	73	72	66	81
	Descarga	54	71	76	82	85	82	79	75	89
2	Aspiración	46	62	69	71	70	71	68	62	77
	Descarga	50	67	72	78	81	79	75	70	85
3	Aspiración	40	57	63	68	68	71	66	60	75
	Descarga	42	63	67	73	79	79	74	69	83
4	Aspiración	49	66	73	75	73	72	71	65	80
	Descarga	53	70	75	81	84	81	78	74	88
5	Aspiración	45	61	68	70	69	70	67	61	76
	Descarga	49	66	71	77	80	78	74	69	84
6	Aspiración	38	55	61	66	66	69	64	58	74
	Descarga	40	61	65	71	77	77	72	67	82
7	Aspiración	46	63	70	72	70	69	68	62	77
	Descarga	50	67	72	78	81	78	75	71	85
8	Aspiración	39	55	62	64	63	64	61	55	70
	Descarga	43	60	65	71	74	72	68	63	78
9	Aspiración	31	48	54	59	59	62	57	51	66
	Descarga	33	54	58	64	70	70	65	60	74
10	Aspiración	29	46	53	55	53	52	51	45	60
	Descarga	33	50	55	61	64	61	58	54	68
11	Aspiración	23	39	46	48	47	48	45	39	54
	Descarga	27	44	49	55	58	56	52	47	62
12	Aspiración	16	33	39	44	44	47	42	36	51
	Descarga	18	39	43	49	55	55	50	45	60

Punto de trabajo		63	125	250	500	1.000	2.000	4.000	8.000	LwA
1	Aspiración	53	68	77	78	77	76	75	75	84
	Descarga	56	76	80	86	88	84	82	80	92
2	Aspiración	50	65	72	73	74	73	71	67	80
	Descarga	53	73	77	82	84	81	77	73	88
3	Aspiración	45	61	67	67	72	73	70	65	78
	Descarga	47	69	73	77	81	81	77	71	86
4	Aspiración	52	67	76	77	76	75	74	74	83
	Descarga	55	75	79	85	87	83	81	79	91
5	Aspiración	49	64	71	72	73	72	70	66	79
	Descarga	52	72	76	81	83	80	76	72	87
6	Aspiración	43	59	65	65	70	71	68	63	76
	Descarga	45	67	71	75	79	79	75	69	84
7	Aspiración	48	63	72	73	72	71	70	70	79
	Descarga	51	71	75	81	83	79	77	75	87
8	Aspiración	39	54	61	62	63	62	60	56	70
	Descarga	42	62	66	71	73	70	66	62	78
9	Aspiración	33	49	55	55	60	61	58	53	66
	Descarga	35	57	61	65	69	69	65	59	74
10	Aspiración	30	45	54	55	54	53	52	52	61
	Descarga	33	53	57	63	65	61	59	57	69
11	Aspiración	25	40	47	48	49	48	46	42	55
	Descarga	28	48	52	57	59	56	52	48	63
12	Aspiración	20	36	42	42	47	48	45	40	52
	Descarga	22	44	48	52	56	56	52	46	60

CURVAS CARACTERÍSTICAS - CARACTERÍSTICAS ACÚSTICAS CRHB 6 Polos

- q_v = Caudal en m^3/h .
- p_{sf} = Presión estática en mmca y Pa.
- Potencia absorbida en W.
- SFP curvas azules en $W/m^3/s$.
- Aire seco normal a $20^\circ C$ y 760 mmHg.
- Ensayos realizados de acuerdo a Norma ISO 5801 y AMCA 210-99.

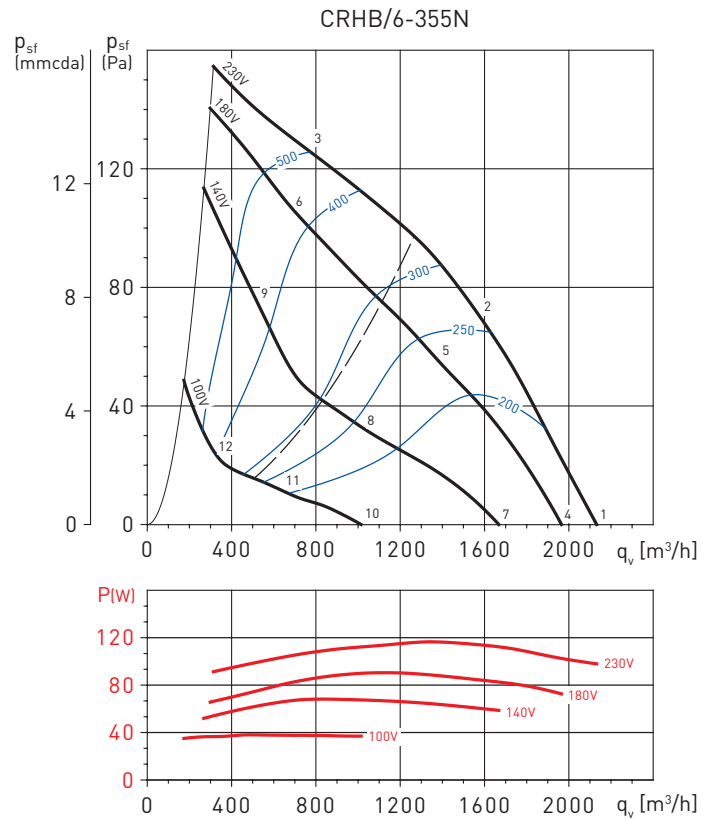
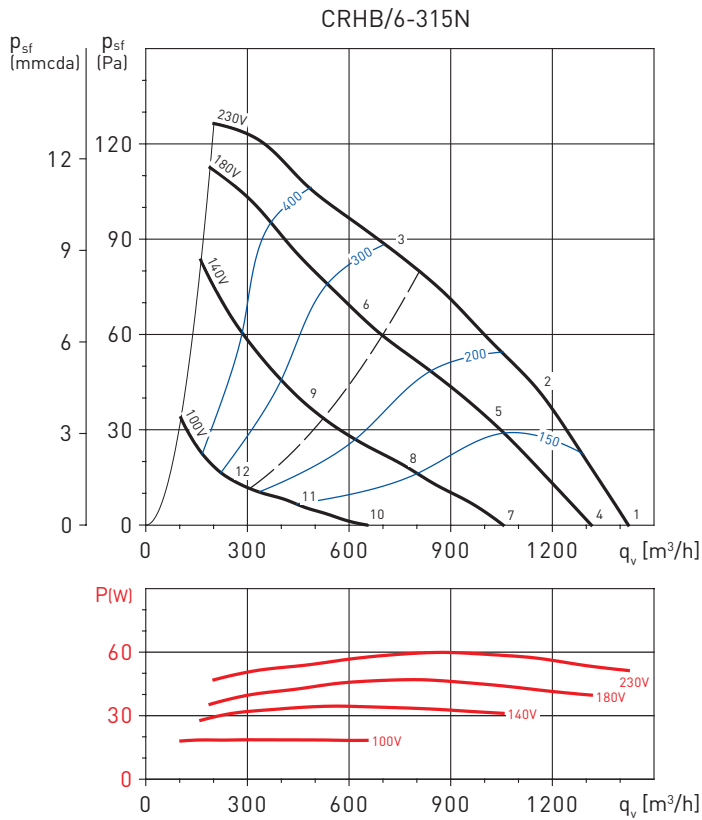

Punto de trabajo		63	125	250	500	1.000	2.000	4.000	8.000	LwA
1	Aspiración	34	43	49	49	51	54	44	33	58
	Descarga	41	53	53	59	59	60	48	37	65
2	Aspiración	30	40	46	48	49	48	39	31	54
	Descarga	38	52	52	58	56	54	44	34	62
3	Aspiración	28	37	43	47	48	41	35	29	52
	Descarga	36	50	51	58	54	47	40	31	61
4	Aspiración	32	41	47	47	49	52	42	31	56
	Descarga	39	51	51	57	57	58	46	35	63
5	Aspiración	27	37	43	45	46	45	36	28	51
	Descarga	35	49	49	55	53	51	41	31	59
6	Aspiración	26	35	41	45	46	39	33	27	49
	Descarga	34	48	49	56	52	45	38	29	58
7	Aspiración	28	37	43	43	45	48	38	27	51
	Descarga	35	47	47	53	53	54	42	31	59
8	Aspiración	21	31	37	39	40	39	30	22	45
	Descarga	29	43	43	49	47	45	35	25	53
9	Aspiración	19	28	34	38	39	32	26	20	43
	Descarga	27	41	42	49	45	38	31	22	52
10	Aspiración	17	26	32	32	34	37	27	16	41
	Descarga	24	36	36	42	42	43	31	20	48
11	Aspiración	10	20	26	28	29	28	19	11	34
	Descarga	18	32	32	38	36	34	24	14	42
12	Aspiración	8	17	23	27	28	21	15	9	32
	Descarga	16	30	31	38	34	27	20	11	41

Punto de trabajo		63	125	250	500	1.000	2.000	4.000	8.000	LwA
1	Aspiración	34	45	51	50	52	56	48	36	59
	Descarga	36	50	54	59	62	63	53	42	67
2	Aspiración	32	42	47	47	49	52	43	34	56
	Descarga	33	46	50	56	59	57	48	38	63
3	Aspiración	34	43	49	49	51	47	40	32	56
	Descarga	34	44	49	56	62	56	49	39	64
4	Aspiración	33	44	50	49	51	55	47	35	58
	Descarga	35	49	53	58	61	62	52	41	66
5	Aspiración	30	40	45	45	47	50	41	32	53
	Descarga	31	44	48	54	57	55	46	36	60
6	Aspiración	32	41	47	47	49	45	38	30	54
	Descarga	32	42	47	54	60	54	47	37	62
7	Aspiración	29	40	46	45	47	51	43	31	55
	Descarga	31	45	49	54	57	58	48	37	62
8	Aspiración	24	34	39	39	41	44	35	26	47
	Descarga	25	38	42	48	51	49	40	30	54
9	Aspiración	28	37	43	43	45	41	34	26	49
	Descarga	28	38	43	50	56	50	43	33	58
10	Aspiración	19	30	36	35	37	41	33	21	44
	Descarga	21	35	39	44	47	48	38	27	52
11	Aspiración	13	23	28	28	30	33	24	15	37
	Descarga	14	27	31	37	40	38	29	19	44
12	Aspiración	16	25	31	31	33	29	22	14	38
	Descarga	16	26	31	38	44	38	31	21	46

CURVAS CARACTERÍSTICAS - CARACTERÍSTICAS ACÚSTICAS CRHB 6 Polos

- q_v = Caudal en m^3/h .
- p_{sf} = Presión estática en mmcda y Pa.
- Potencia absorbida en W.
- SFP curvas azules en $W/m^3/s$.
- Aire seco normal a $20^\circ C$ y 760 mmHg.
- Ensayos realizados de acuerdo a Norma ISO 5801 y AMCA 210-99.

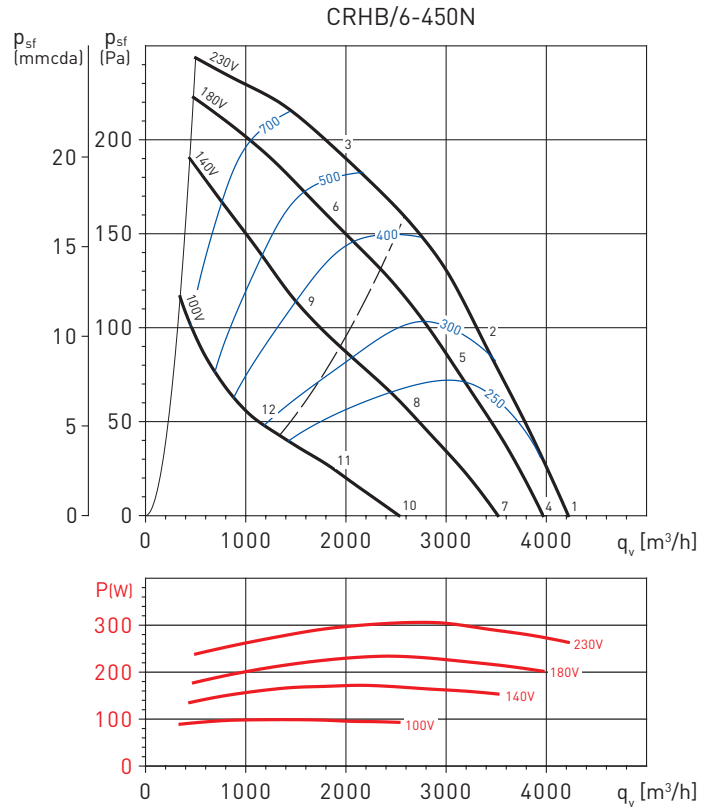
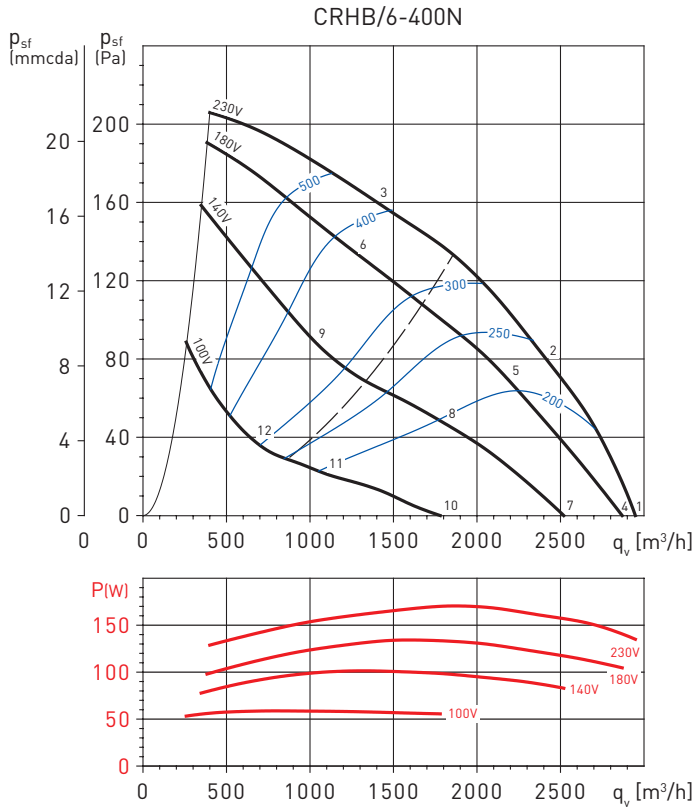

Punto de trabajo		63	125	250	500	1.000	2.000	4.000	8.000	LwA
1	Aspiración	37	48	57	58	62	64	52	42	67
	Descarga	39	54	59	64	68	68	57	47	72
2	Aspiración	33	43	51	55	59	58	48	39	63
	Descarga	37	50	55	61	65	62	53	43	68
3	Aspiración	33	42	49	54	53	53	46	37	59
	Descarga	37	48	53	60	63	59	51	42	66
4	Aspiración	36	47	56	57	61	63	51	41	66
	Descarga	38	53	58	63	67	67	56	46	71
5	Aspiración	31	41	49	53	57	56	46	37	61
	Descarga	35	48	53	59	63	60	51	41	66
6	Aspiración	31	40	47	52	51	51	44	35	57
	Descarga	35	46	51	58	61	57	49	40	64
7	Aspiración	33	44	53	54	58	60	48	38	64
	Descarga	35	50	55	60	64	64	53	43	69
8	Aspiración	27	37	45	49	53	52	42	33	57
	Descarga	31	44	49	55	59	56	47	37	62
9	Aspiración	27	36	43	48	47	47	40	31	53
	Descarga	31	42	47	54	57	53	45	36	60
10	Aspiración	26	37	46	47	51	53	41	31	56
	Descarga	28	43	48	53	57	57	46	36	61
11	Aspiración	18	28	36	40	44	43	33	24	48
	Descarga	22	35	40	46	50	47	38	28	53
12	Aspiración	17	26	33	38	37	37	30	21	43
	Descarga	21	32	37	44	47	43	35	26	51

Punto de trabajo		63	125	250	500	1.000	2.000	4.000	8.000	LwA
1	Aspiración	40	52	60	61	63	66	58	49	70
	Descarga	43	59	65	70	72	72	64	56	77
2	Aspiración	40	49	55	57	63	61	55	46	67
	Descarga	40	56	62	68	70	67	61	53	74
3	Aspiración	40	46	52	56	57	58	53	44	63
	Descarga	40	55	64	69	70	66	60	53	74
4	Aspiración	39	51	59	60	62	65	57	48	68
	Descarga	42	58	64	69	71	71	63	55	76
5	Aspiración	38	47	53	55	61	59	53	44	65
	Descarga	38	54	60	66	68	65	59	51	72
6	Aspiración	38	44	50	54	55	56	51	42	61
	Descarga	38	53	62	67	68	64	58	51	72
7	Aspiración	36	48	56	57	59	62	54	45	66
	Descarga	39	55	61	66	68	68	60	52	73
8	Aspiración	35	44	50	52	58	56	50	41	61
	Descarga	35	51	57	63	65	62	56	48	69
9	Aspiración	34	40	46	50	51	52	47	38	57
	Descarga	34	49	58	63	64	60	54	47	68
10	Aspiración	29	41	49	50	52	55	47	38	59
	Descarga	32	48	54	59	61	61	53	45	66
11	Aspiración	27	36	42	44	50	48	42	33	53
	Descarga	27	43	49	55	57	54	48	40	60
12	Aspiración	26	32	38	42	43	44	39	30	49
	Descarga	26	41	50	55	56	52	46	39	60

CURVAS CARACTERÍSTICAS - CARACTERÍSTICAS ACÚSTICAS CRHB 6 Polos

- q_v = Caudal en m^3/h .
- p_{sf} = Presión estática en mmcda y Pa.
- Potencia absorbida en W.
- SFP curvas azules en $W/m^3/s$.
- Aire seco normal a $20^\circ C$ y 760 mmHg.
- Ensayos realizados de acuerdo a Norma ISO 5801 y AMCA 210-99.

CRHB/6-500N

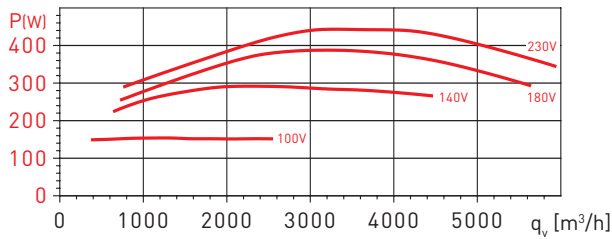
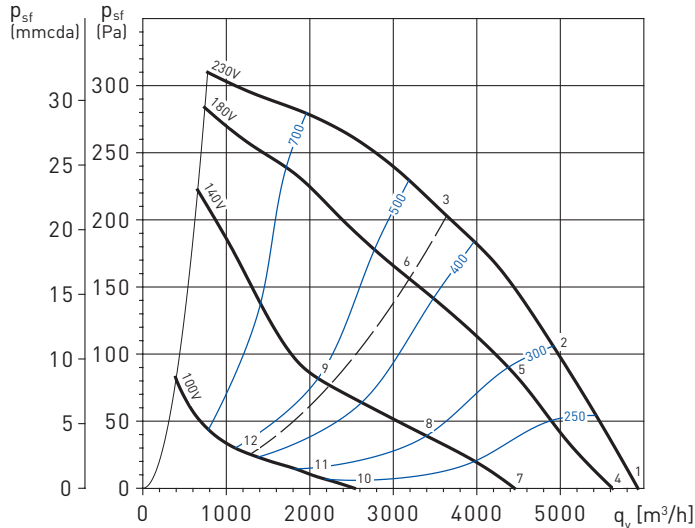

CRHB/6-560N

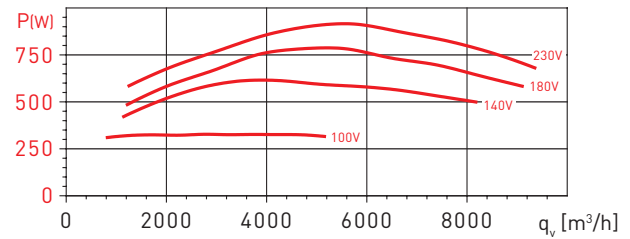
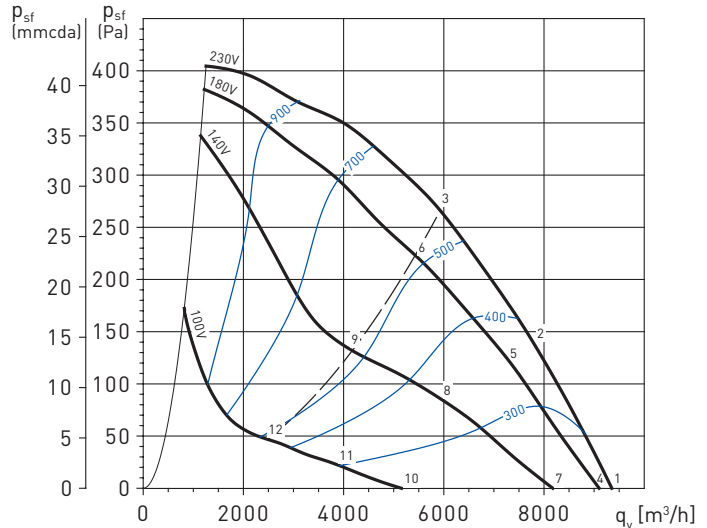

Punto de trabajo		63	125	250	500	1.000	2.000	4.000	8.000	LwA
1	Aspiración	45	56	64	63	64	66	62	53	71
	Descarga	47	61	67	72	74	73	69	59	79
2	Aspiración	41	52	60	60	62	63	59	51	68
	Descarga	43	58	64	69	71	69	65	57	75
3	Aspiración	37	49	56	58	60	62	57	50	66
	Descarga	42	54	60	67	71	69	64	56	75
4	Aspiración	44	55	63	62	63	65	61	52	70
	Descarga	46	60	66	71	73	72	68	58	78
5	Aspiración	39	50	58	58	60	61	57	49	66
	Descarga	41	56	62	67	69	67	63	55	73
6	Aspiración	34	46	53	55	57	59	54	47	64
	Descarga	39	51	57	64	68	66	61	53	72
7	Aspiración	39	50	58	57	58	60	56	47	65
	Descarga	41	55	61	66	68	67	63	53	72
8	Aspiración	32	43	51	51	53	54	50	42	59
	Descarga	34	49	55	60	62	60	56	48	66
9	Aspiración	26	38	45	47	49	51	46	39	56
	Descarga	31	43	49	56	60	58	53	45	64
10	Aspiración	27	38	46	45	46	48	44	35	53
	Descarga	29	43	49	54	56	55	51	41	60
11	Aspiración	20	31	39	39	41	42	38	30	47
	Descarga	22	37	43	48	50	48	44	36	54
12	Aspiración	14	26	33	35	37	39	34	27	44
	Descarga	19	31	37	44	48	46	41	33	52

Punto de trabajo		63	125	250	500	1.000	2.000	4.000	8.000	LwA
1	Aspiración	50	65	70	70	70	71	67	63	77
	Descarga	53	70	75	80	80	76	73	66	85
2	Aspiración	46	61	67	68	66	65	62	57	73
	Descarga	49	68	72	77	76	70	67	61	81
3	Aspiración	42	57	65	65	65	63	60	55	71
	Descarga	43	63	68	72	73	69	65	61	78
4	Aspiración	49	64	69	69	69	70	66	62	76
	Descarga	52	69	74	79	79	75	72	65	84
5	Aspiración	45	60	66	67	65	64	61	56	72
	Descarga	48	67	71	76	75	69	66	60	80
6	Aspiración	40	55	63	63	63	61	58	53	69
	Descarga	41	61	66	70	71	67	63	59	76
7	Aspiración	47	62	67	67	67	68	64	60	74
	Descarga	50	67	72	77	77	73	70	63	82
8	Aspiración	41	56	62	63	61	60	57	52	68
	Descarga	44	63	67	72	71	65	62	56	76
9	Aspiración	35	50	58	58	58	56	53	48	64
	Descarga	36	56	61	65	66	62	58	54	70
10	Aspiración	37	52	57	57	57	58	54	50	64
	Descarga	40	57	62	67	67	63	60	53	72
11	Aspiración	29	44	50	51	49	48	45	40	56
	Descarga	32	51	55	60	59	53	50	44	64
12	Aspiración	23	38	46	46	46	44	41	36	53
	Descarga	24	44	49	53	54	50	46	42	59

CURVAS CARACTERÍSTICAS - CARACTERÍSTICAS ACÚSTICAS CRHB 6 Polos

- q_v = Caudal en m^3/h .
- p_{sf} = Presión estática en mmcda y Pa.
- Potencia absorbida en W.
- SFP curvas azules en $W/m^3/s$.
- Aire seco normal a $20^\circ C$ y 760 mmHg.
- Ensayos realizados de acuerdo a Norma ISO 5801 y AMCA 210-99.

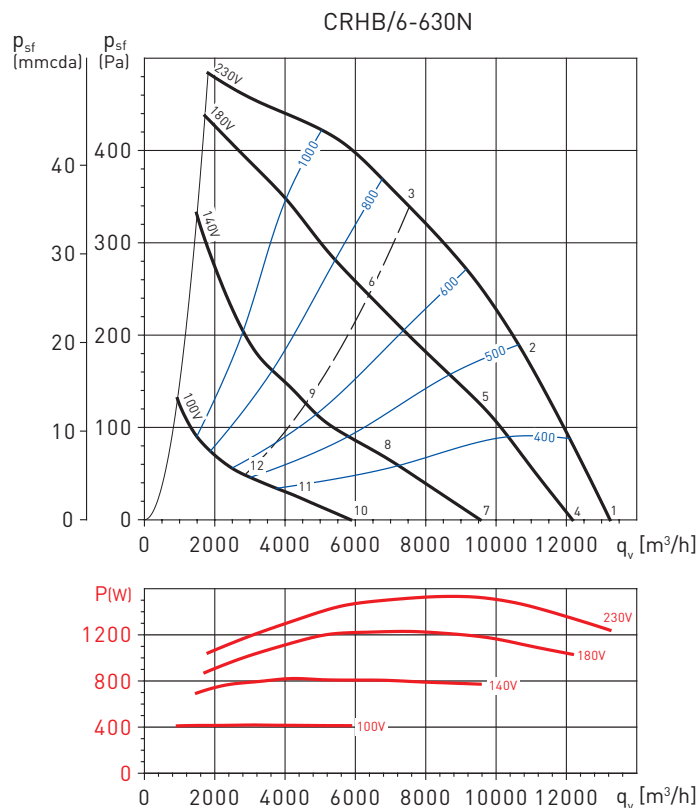

Punto de trabajo		63	125	250	500	1.000	2.000	4.000	8.000	LwA
1	Aspiración	54	71	74	72	74	75	67	63	81
	Descarga	58	77	79	84	83	81	75	68	89
2	Aspiración	50	67	71	67	70	68	64	58	76
	Descarga	55	74	76	79	78	75	71	64	84
3	Aspiración	48	64	69	64	68	66	62	56	74
	Descarga	51	69	72	74	76	75	70	64	81
4	Aspiración	52	69	72	70	72	73	65	61	79
	Descarga	56	75	77	82	81	79	73	66	87
5	Aspiración	47	64	68	64	67	65	61	55	73
	Descarga	52	71	73	76	75	72	68	61	81
6	Aspiración	44	60	65	60	64	62	58	52	70
	Descarga	47	65	68	70	72	71	66	60	77
7	Aspiración	47	64	67	65	67	68	60	56	74
	Descarga	51	70	72	77	76	74	68	61	82
8	Aspiración	40	57	61	57	60	58	54	48	66
	Descarga	45	64	66	69	68	65	61	54	74
9	Aspiración	37	53	58	53	57	55	51	45	63
	Descarga	40	58	61	63	65	64	59	53	70
10	Aspiración	36	53	56	54	56	57	49	45	63
	Descarga	40	59	61	66	65	63	57	50	71
11	Aspiración	29	46	50	46	49	47	43	37	56
	Descarga	34	53	55	58	57	54	50	43	64
12	Aspiración	27	43	48	43	47	45	41	35	53
	Descarga	30	48	51	53	55	54	49	43	60

CURVAS CARACTERÍSTICAS - CARACTERÍSTICAS ACÚSTICAS CRHT 4 Polos

- q_v = Caudal en m^3/h .
- p_{sf} = Presión estática en mmca y Pa.
- Potencia absorbida en W.
- SFP curvas azules en $W/m^3/s$.
- Aire seco normal a $20^\circ C$ y 760 mmHg.
- Ensayos realizados de acuerdo a Norma ISO 5801 y AMCA 210-99.

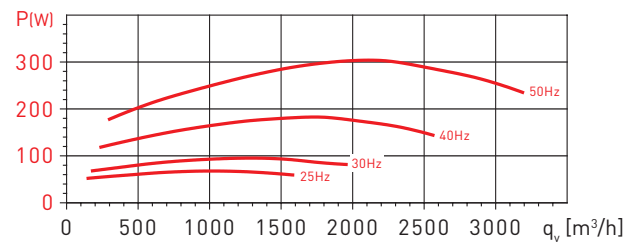
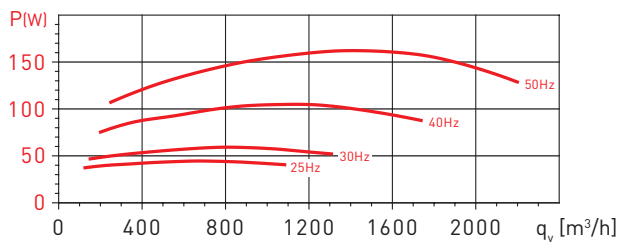
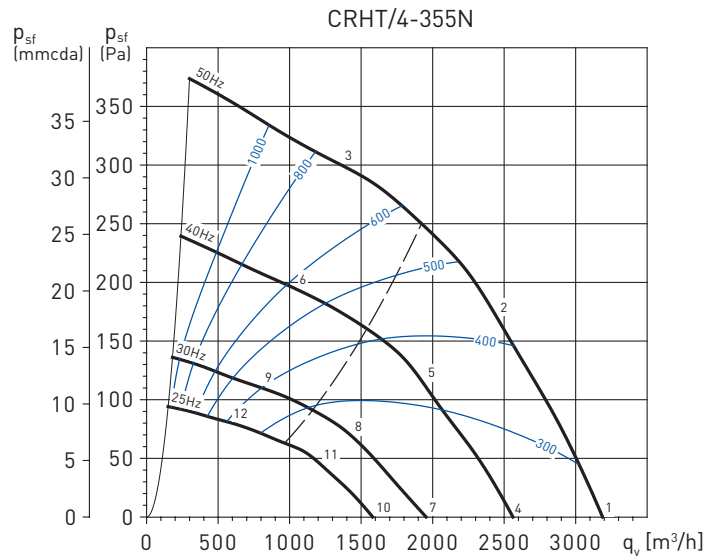
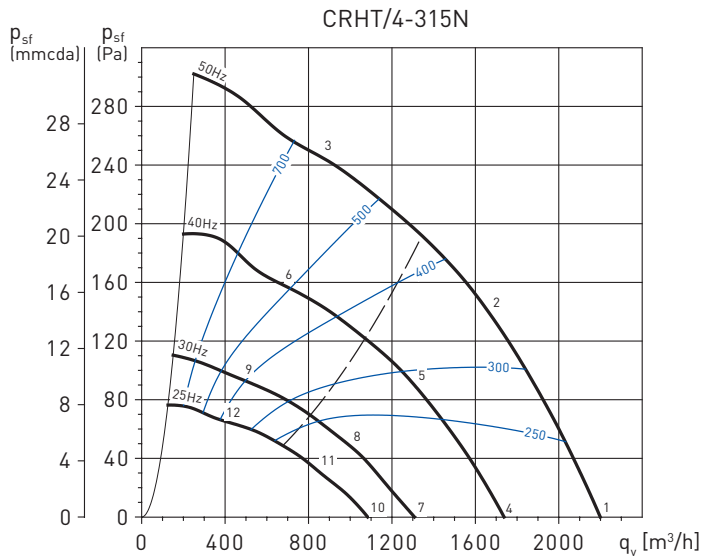

Punto de trabajo		63	125	250	500	1.000	2.000	4.000	8.000	LwA
1	Aspiración	39	55	60	59	60	61	60	46	67
	Descarga	40	58	61	67	69	67	65	52	74
2	Aspiración	34	50	54	54	54	56	51	41	61
	Descarga	35	54	56	62	65	63	55	46	69
3	Aspiración	39	51	55	54	55	52	46	38	61
	Descarga	40	53	56	61	66	62	55	47	69
4	Aspiración	34	50	55	54	55	56	55	41	63
	Descarga	35	53	56	62	64	62	60	47	69
5	Aspiración	29	45	49	49	49	51	46	36	57
	Descarga	30	49	51	57	60	58	50	41	64
6	Aspiración	34	46	50	49	50	47	41	33	56
	Descarga	35	48	51	56	61	57	50	42	64
7	Aspiración	28	44	49	48	49	50	49	35	57
	Descarga	29	47	50	56	58	56	54	41	63
8	Aspiración	23	39	43	43	43	45	40	30	51
	Descarga	24	43	45	51	54	52	44	35	58
9	Aspiración	28	40	44	43	44	41	35	27	50
	Descarga	29	42	45	50	55	51	44	36	58
10	Aspiración	24	40	45	44	45	46	45	31	53
	Descarga	25	43	46	52	54	52	50	37	59
11	Aspiración	19	35	39	39	39	41	36	26	47
	Descarga	20	39	41	47	50	48	40	31	54
12	Aspiración	24	36	40	39	40	37	31	23	46
	Descarga	25	38	41	46	51	47	40	32	54

Punto de trabajo		63	125	250	500	1.000	2.000	4.000	8.000	LwA
1	Aspiración	41	57	62	61	62	63	62	48	69
	Descarga	42	60	63	69	71	69	67	54	75
2	Aspiración	36	52	56	56	56	58	53	43	64
	Descarga	37	56	58	64	67	65	57	48	71
3	Aspiración	41	53	57	56	57	54	48	40	63
	Descarga	42	55	58	63	68	64	57	49	71
4	Aspiración	36	52	57	56	57	58	57	43	64
	Descarga	37	55	58	64	66	64	62	49	71
5	Aspiración	32	48	52	52	52	54	49	39	59
	Descarga	33	52	54	60	63	61	53	44	66
6	Aspiración	36	48	52	51	52	49	43	35	58
	Descarga	37	50	53	58	63	59	52	44	66
7	Aspiración	30	46	51	50	51	52	51	37	58
	Descarga	31	49	52	58	60	58	56	43	64
8	Aspiración	26	42	46	46	46	48	43	33	53
	Descarga	27	46	48	54	57	55	47	38	60
9	Aspiración	30	42	46	45	46	43	37	29	52
	Descarga	31	44	47	52	57	53	46	38	60
10	Aspiración	26	42	47	46	47	48	47	33	54
	Descarga	27	45	48	54	56	54	52	39	61
11	Aspiración	22	38	42	42	42	44	39	29	49
	Descarga	23	42	44	50	53	51	43	34	57
12	Aspiración	26	38	42	41	42	39	33	25	48
	Descarga	27	40	43	48	53	49	42	34	56

CURVAS CARACTERÍSTICAS - CARACTERÍSTICAS ACÚSTICAS CRHT 4 Polos

- q_v = Caudal en m^3/h .
- p_{sf} = Presión estática en mmcda y Pa.
- Potencia absorbida en W.
- SFP curvas azules en $W/m^3/s$.
- Aire seco normal a $20^\circ C$ y 760 mmHg.
- Ensayos realizados de acuerdo a Norma ISO 5801 y AMCA 210-99.

CRHT/4-400N

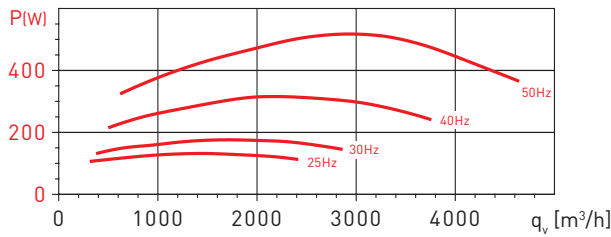
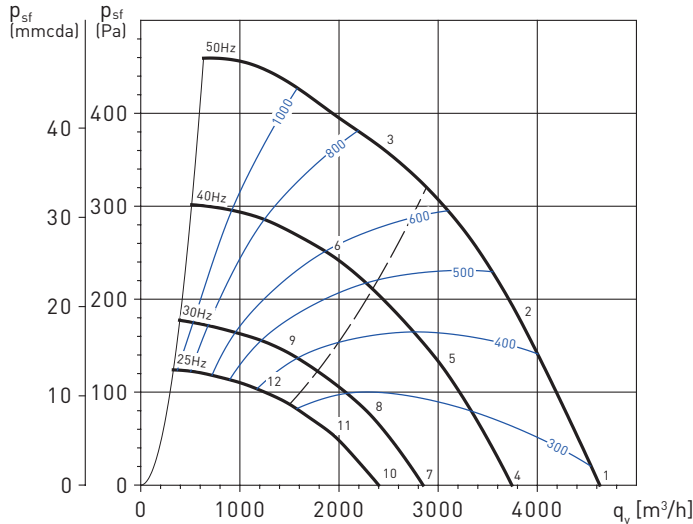

CRHT/4-450N

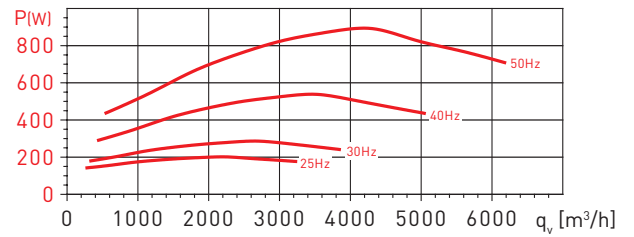
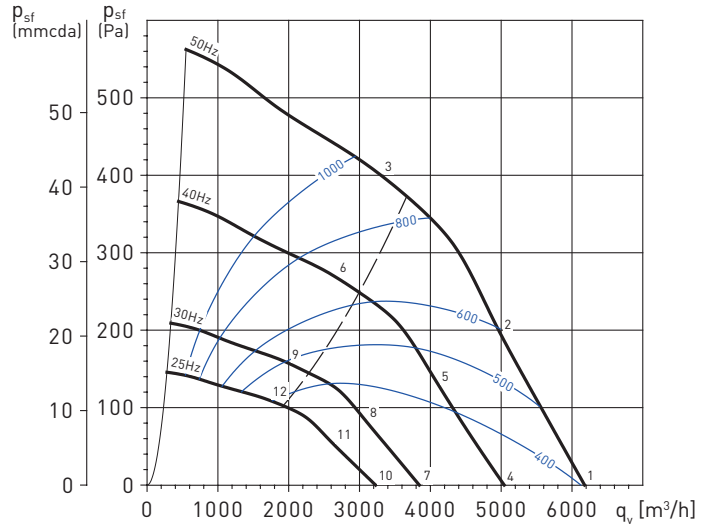

Punto de trabajo		63	125	250	500	1.000	2.000	4.000	8.000	LwA
1	Aspiración	40	60	67	69	67	69	68	58	75
	Descarga	44	65	69	75	78	75	73	63	82
2	Aspiración	38	56	60	63	64	67	64	56	71
	Descarga	40	61	64	70	74	72	68	61	78
3	Aspiración	37	52	58	60	63	65	62	54	69
	Descarga	38	57	62	68	73	71	67	60	77
4	Aspiración	35	55	62	64	62	64	63	53	71
	Descarga	39	60	64	70	73	70	68	58	78
5	Aspiración	34	52	56	59	60	63	60	52	67
	Descarga	36	57	60	66	70	68	64	57	74
6	Aspiración	33	48	54	56	59	61	58	50	65
	Descarga	34	53	58	64	69	67	63	56	72
7	Aspiración	30	50	57	59	57	59	58	48	65
	Descarga	34	55	59	65	68	65	63	53	72
8	Aspiración	28	46	50	53	54	57	54	46	61
	Descarga	30	51	54	60	64	62	58	51	68
9	Aspiración	27	42	48	50	53	55	52	44	59
	Descarga	28	47	52	58	63	61	57	50	67
10	Aspiración	26	46	53	55	53	55	54	44	61
	Descarga	30	51	55	61	64	61	59	49	68
11	Aspiración	24	42	46	49	50	53	50	42	57
	Descarga	26	47	50	56	60	58	54	47	64
12	Aspiración	23	38	44	46	49	51	48	40	56
	Descarga	24	43	48	54	59	57	53	46	63

Punto de trabajo		63	125	250	500	1.000	2.000	4.000	8.000	LwA
1	Aspiración	44	64	69	72	72	72	71	62	79
	Descarga	48	70	73	80	83	80	78	71	87
2	Aspiración	41	60	66	68	68	70	66	58	75
	Descarga	45	67	70	76	79	77	73	67	83
3	Aspiración	43	55	63	65	66	67	63	56	72
	Descarga	46	62	67	72	77	76	71	65	81
4	Aspiración	40	60	65	68	68	68	67	58	74
	Descarga	44	66	69	76	79	76	74	67	83
5	Aspiración	37	56	62	64	64	66	62	54	71
	Descarga	41	63	66	72	75	73	69	63	79
6	Aspiración	39	51	59	61	62	63	59	52	68
	Descarga	42	58	63	68	73	72	67	61	77
7	Aspiración	34	54	59	62	62	62	61	52	68
	Descarga	38	60	63	70	73	70	68	61	77
8	Aspiración	31	50	56	58	58	60	56	48	65
	Descarga	35	57	60	66	69	67	63	57	73
9	Aspiración	33	45	53	55	56	57	53	46	62
	Descarga	36	52	57	62	67	66	61	55	71
10	Aspiración	30	50	55	58	58	58	57	48	64
	Descarga	34	56	59	66	69	66	64	57	73
11	Aspiración	27	46	52	54	54	56	52	44	61
	Descarga	31	53	56	62	65	63	59	53	69
12	Aspiración	29	41	49	51	52	53	49	42	58
	Descarga	32	48	53	58	63	62	57	51	67

CURVAS CARACTERÍSTICAS - CARACTERÍSTICAS ACÚSTICAS CRHT 4 Polos

- q_v = Caudal en m^3/h .
- p_{sf} = Presión estática en mmcda y Pa.
- Potencia absorbida en W.
- SFP curvas azules en $W/m^3/s$.
- Aire seco normal a $20^\circ C$ y 760 mmHg.
- Ensayos realizados de acuerdo a Norma ISO 5801 y AMCA 210-99.

CRHT/4-500N

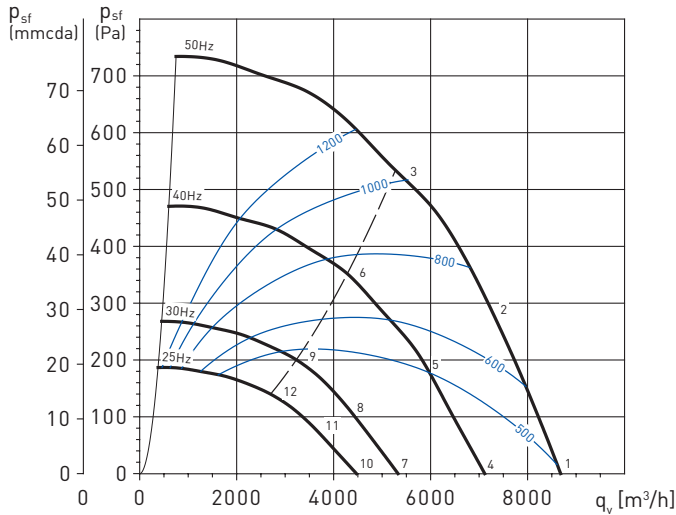

CRHT/4-560N

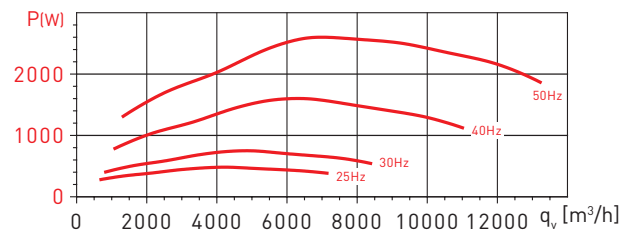
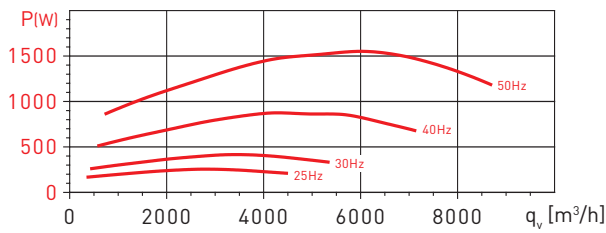
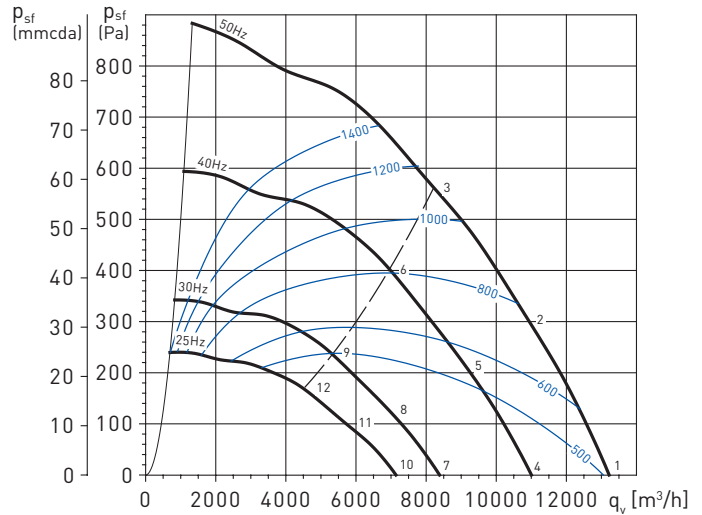

Punto de trabajo		63	125	250	500	1.000	2.000	4.000	8.000	LwA
1	Aspiración	52	68	77	78	77	77	76	75	85
	Descarga	58	75	80	86	88	85	83	81	93
2	Aspiración	50	65	73	72	74	75	74	67	81
	Descarga	53	71	76	81	84	82	79	74	88
3	Aspiración	44	60	67	67	72	75	73	66	79
	Descarga	47	66	71	77	81	82	78	72	86
4	Aspiración	47	63	72	73	72	72	71	70	80
	Descarga	53	70	75	81	83	80	78	76	88
5	Aspiración	45	60	68	67	69	70	69	62	76
	Descarga	48	66	71	76	79	77	74	69	84
6	Aspiración	39	55	62	62	67	70	68	61	74
	Descarga	42	61	66	72	76	77	73	67	82
7	Aspiración	41	57	66	67	66	66	65	64	74
	Descarga	47	64	69	75	77	74	72	70	82
8	Aspiración	39	54	62	61	63	64	63	56	70
	Descarga	42	60	65	70	73	71	68	63	78
9	Aspiración	33	49	56	56	61	64	62	55	68
	Descarga	36	55	60	66	70	71	67	61	75
10	Aspiración	37	53	62	63	62	62	61	60	70
	Descarga	43	60	65	71	73	70	68	66	78
11	Aspiración	35	50	58	57	59	60	59	52	66
	Descarga	38	56	61	66	69	67	64	59	74
12	Aspiración	29	45	52	52	57	60	58	51	64
	Descarga	32	51	56	62	66	67	63	57	72

Punto de trabajo		63	125	250	500	1.000	2.000	4.000	8.000	LwA
1	Aspiración	55	72	81	80	81	79	78	77	87
	Descarga	59	76	86	91	92	86	85	81	96
2	Aspiración	52	71	77	76	77	75	71	69	83
	Descarga	56	75	83	87	88	82	77	75	92
3	Aspiración	48	67	71	70	72	72	69	66	79
	Descarga	51	71	77	81	83	79	76	71	87
4	Aspiración	51	68	77	76	77	75	74	73	83
	Descarga	55	72	82	87	88	82	81	77	92
5	Aspiración	48	67	73	72	73	71	67	65	79
	Descarga	52	71	79	83	84	78	73	71	88
6	Aspiración	44	63	67	66	68	68	65	62	75
	Descarga	47	67	73	77	79	75	72	67	83
7	Aspiración	45	62	71	70	71	69	68	67	77
	Descarga	49	66	76	81	82	76	75	71	86
8	Aspiración	42	61	67	66	67	65	61	59	73
	Descarga	46	65	73	77	78	72	67	65	82
9	Aspiración	38	57	61	60	62	62	59	56	69
	Descarga	41	61	67	71	73	69	66	61	78
10	Aspiración	41	58	67	66	67	65	64	63	74
	Descarga	45	62	72	77	78	72	71	67	82
11	Aspiración	38	57	63	62	63	61	57	55	70
	Descarga	42	61	69	73	74	68	63	61	79
12	Aspiración	35	54	58	57	59	59	56	53	65
	Descarga	38	58	64	68	70	66	63	58	74

CURVAS CARACTERÍSTICAS - CARACTERÍSTICAS ACÚSTICAS CRHT 6 Polos

- q_v = Caudal en m^3/h .
- p_{sf} = Presión estática en mmcda y Pa.
- Potencia absorbida en W.
- SFP curvas azules en $W/m^3/s$.
- Aire seco normal a $20^\circ C$ y 760 mmHg.
- Ensayos realizados de acuerdo a Norma ISO 5801 y AMCA 210-99.

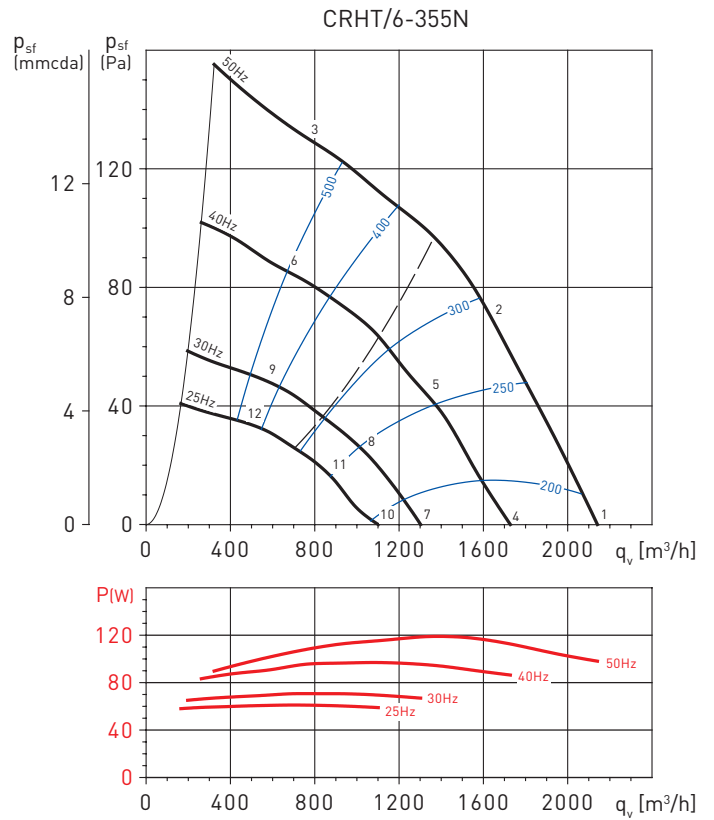
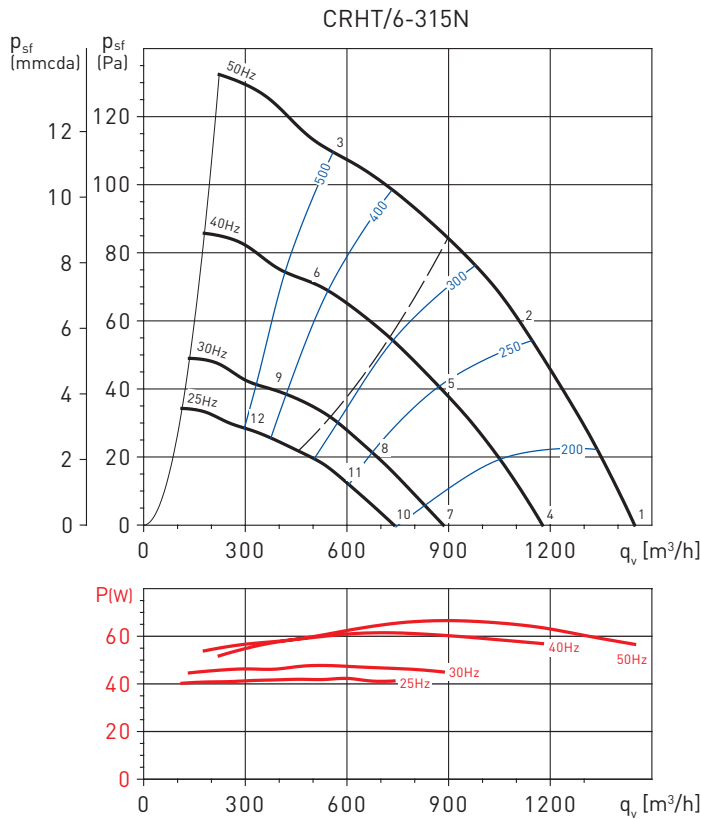

Punto de trabajo		63	125	250	500	1.000	2.000	4.000	8.000	LwA
1	Aspiración	35	46	49	48	52	60	41	33	61
	Descarga	38	50	51	56	61	65	46	36	67
2	Aspiración	33	45	44	44	49	46	35	28	53
	Descarga	41	45	47	52	58	52	40	34	60
3	Aspiración	34	45	45	45	46	39	32	27	51
	Descarga	38	44	47	54	56	48	39	34	59
4	Aspiración	30	41	44	43	47	55	36	28	57
	Descarga	33	45	46	51	56	60	41	31	62
5	Aspiración	28	40	39	39	44	41	30	23	48
	Descarga	36	40	42	47	53	47	35	29	56
6	Aspiración	29	40	40	40	41	34	27	22	47
	Descarga	33	39	42	49	51	43	34	29	54
7	Aspiración	24	35	38	37	41	49	30	22	51
	Descarga	27	39	40	45	50	54	35	25	56
8	Aspiración	22	34	33	33	38	35	24	17	43
	Descarga	30	34	36	41	47	41	29	23	50
9	Aspiración	23	34	34	34	35	28	21	16	41
	Descarga	27	33	36	43	45	37	28	23	48
10	Aspiración	20	31	34	33	37	45	26	18	47
	Descarga	23	35	36	41	46	50	31	21	53
11	Aspiración	19	31	30	30	35	32	21	14	39
	Descarga	27	31	33	38	44	38	26	20	46
12	Aspiración	19	30	30	30	31	24	17	12	37
	Descarga	23	29	32	39	41	33	24	19	44

Punto de trabajo		63	125	250	500	1.000	2.000	4.000	8.000	LwA
1	Aspiración	37	47	52	50	53	56	46	35	60
	Descarga	42	52	54	61	63	63	50	40	68
2	Aspiración	38	44	47	47	49	49	40	30	55
	Descarga	45	50	52	62	61	57	46	37	66
3	Aspiración	36	45	48	49	48	44	37	29	54
	Descarga	40	49	52	64	62	54	45	37	67
4	Aspiración	33	43	48	46	49	52	42	31	56
	Descarga	38	48	50	57	59	59	46	36	63
5	Aspiración	34	40	43	43	45	45	36	26	51
	Descarga	41	46	48	58	57	53	42	33	62
6	Aspiración	32	41	44	45	44	40	33	25	50
	Descarga	36	45	48	60	58	50	41	33	62
7	Aspiración	27	37	42	40	43	46	36	25	50
	Descarga	32	42	44	51	53	53	40	30	57
8	Aspiración	28	34	37	37	39	39	30	20	45
	Descarga	35	40	42	52	51	47	36	27	56
9	Aspiración	26	35	38	39	38	34	27	19	44
	Descarga	30	39	42	54	52	44	35	27	56
10	Aspiración	23	33	38	36	39	42	32	21	46
	Descarga	28	38	40	47	49	49	36	26	54
11	Aspiración	24	30	33	33	35	35	26	16	41
	Descarga	31	36	38	48	47	43	32	23	52
12	Aspiración	22	31	34	35	34	30	23	15	40
	Descarga	26	35	38	50	48	40	31	23	53

CURVAS CARACTERÍSTICAS - CARACTERÍSTICAS ACÚSTICAS CRHT 6 Polos

- q_v = Caudal en m^3/h .
- p_{sf} = Presión estática en mmcda y Pa.
- Potencia absorbida en W.
- SFP curvas azules en $W/m^3/s$.
- Aire seco normal a $20^\circ C$ y 760 mmHg.
- Ensayos realizados de acuerdo a Norma ISO 5801 y AMCA 210-99.

CRHT/6-400N

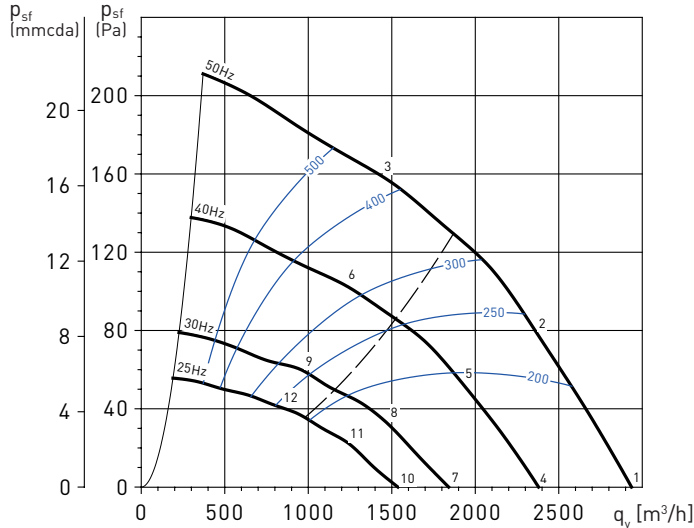

CRHT/6-450N

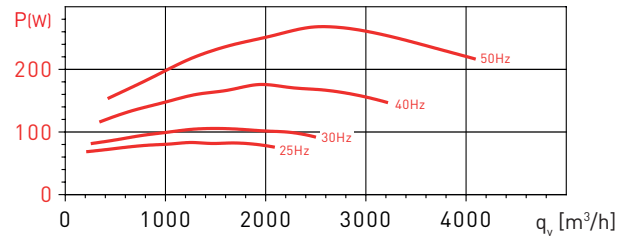
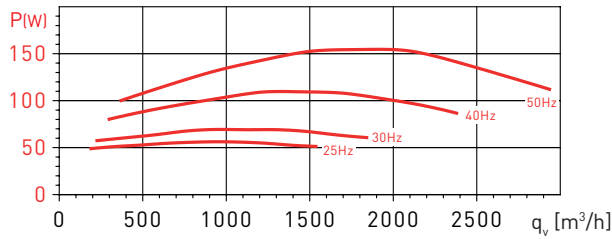
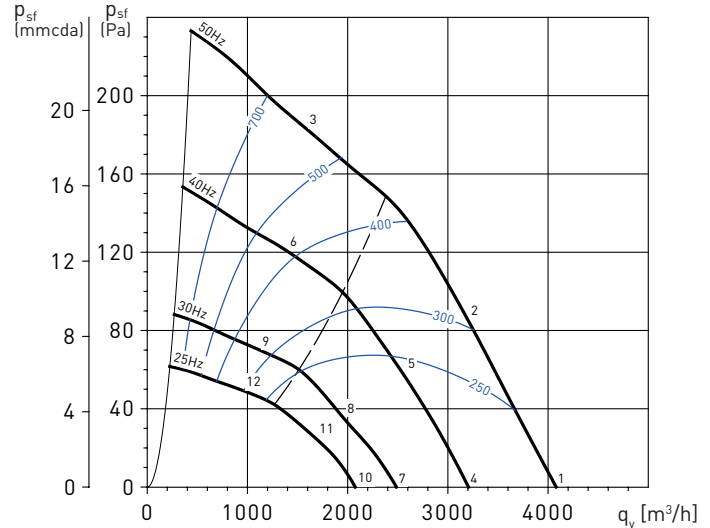

Punto de trabajo		63	125	250	500	1.000	2.000	4.000	8.000	LwA
1	Aspiración	38	50	57	58	63	64	52	42	68
	Descarga	41	55	60	65	68	68	56	48	72
2	Aspiración	34	46	52	54	58	58	48	38	63
	Descarga	35	50	55	61	65	62	52	43	68
3	Aspiración	33	43	50	53	53	52	45	37	59
	Descarga	36	49	53	60	63	58	51	42	66
4	Aspiración	33	45	52	53	58	59	47	37	63
	Descarga	36	50	55	60	63	63	51	43	68
5	Aspiración	30	42	48	50	54	54	44	34	58
	Descarga	31	46	51	57	61	58	48	39	64
6	Aspiración	29	39	46	49	49	48	41	33	54
	Descarga	32	45	49	56	59	54	47	38	62
7	Aspiración	27	39	46	47	52	53	41	31	57
	Descarga	30	44	49	54	57	57	45	37	62
8	Aspiración	24	36	42	44	48	48	38	28	52
	Descarga	25	40	45	51	55	52	42	33	58
9	Aspiración	23	33	40	43	43	42	35	27	48
	Descarga	26	39	43	50	53	48	41	32	56
10	Aspiración	24	36	43	44	49	50	38	28	53
	Descarga	27	41	46	51	54	54	42	34	58
11	Aspiración	20	32	38	40	44	44	34	24	48
	Descarga	21	36	41	47	51	48	38	29	54
12	Aspiración	19	29	36	39	39	38	31	23	45
	Descarga	22	35	39	46	49	44	37	28	52

Punto de trabajo		63	125	250	500	1.000	2.000	4.000	8.000	LwA
1	Aspiración	43	49	57	59	64	64	55	46	68
	Descarga	40	55	61	66	70	70	61	53	74
2	Aspiración	45	46	54	55	62	58	49	40	65
	Descarga	41	51	57	63	67	64	56	48	70
3	Aspiración	46	47	53	54	55	54	48	39	61
	Descarga	40	50	55	61	67	64	58	50	70
4	Aspiración	39	45	53	55	60	60	51	42	64
	Descarga	36	51	57	62	66	66	57	49	70
5	Aspiración	41	42	50	51	58	54	45	36	60
	Descarga	37	47	53	59	63	60	52	44	66
6	Aspiración	42	43	49	50	51	50	44	35	56
	Descarga	36	46	51	57	63	60	54	46	66
7	Aspiración	33	39	47	49	54	54	45	36	58
	Descarga	30	45	51	56	60	60	51	43	64
8	Aspiración	34	35	43	44	51	47	38	29	54
	Descarga	30	40	46	52	56	53	45	37	59
9	Aspiración	36	37	43	44	45	44	38	29	51
	Descarga	30	40	45	51	57	54	48	40	60
10	Aspiración	29	35	43	45	50	50	41	32	54
	Descarga	26	41	47	52	56	56	47	39	60
11	Aspiración	30	31	39	40	47	43	34	25	50
	Descarga	26	36	42	48	52	49	41	33	56
12	Aspiración	32	33	39	40	41	40	34	25	47
	Descarga	26	36	41	47	53	50	44	36	56

CURVAS CARACTERÍSTICAS - CARACTERÍSTICAS ACÚSTICAS CRHT 6 Polos

- q_v = Caudal en m^3/h .
- p_{sf} = Presión estática en mmcda y Pa.
- Potencia absorbida en W.
- SFP curvas azules en $W/m^3/s$.
- Aire seco normal a $20^\circ C$ y 760 mmHg.
- Ensayos realizados de acuerdo a Norma ISO 5801 y AMCA 210-99.

CRHT/6-500N

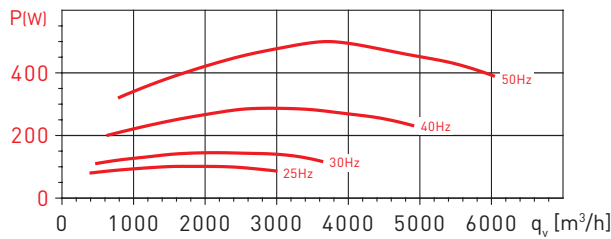
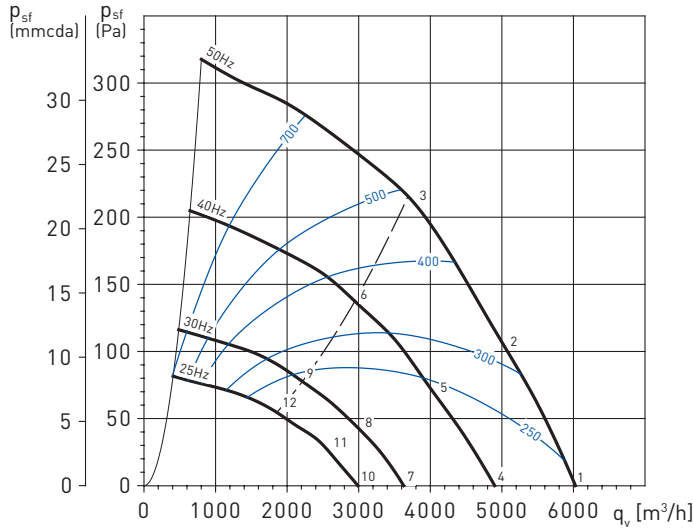

CRHT/6-560N

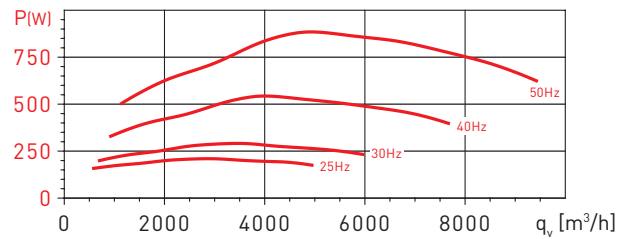
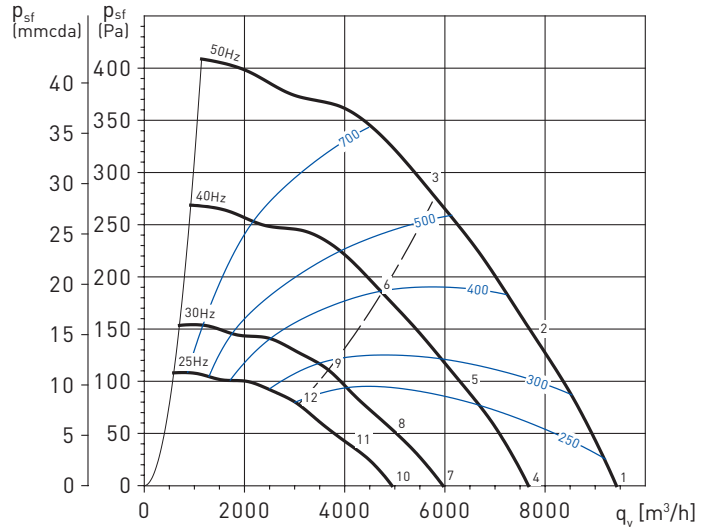

Punto de trabajo		63	125	250	500	1.000	2.000	4.000	8.000	LwA
1	Aspiración	43	56	63	61	62	65	61	53	70
	Descarga	45	62	66	72	73	72	68	61	78
2	Aspiración	38	53	58	57	59	61	58	51	66
	Descarga	41	59	63	68	70	68	64	58	75
3	Aspiración	34	49	55	56	59	60	57	50	65
	Descarga	38	55	60	67	70	68	63	56	74
4	Aspiración	38	51	58	56	57	60	56	48	65
	Descarga	40	57	61	67	68	67	63	56	73
5	Aspiración	33	48	53	52	54	56	53	46	61
	Descarga	36	54	58	63	65	63	59	53	70
6	Aspiración	29	44	50	51	54	55	52	45	60
	Descarga	33	50	55	62	65	63	58	51	69
7	Aspiración	32	45	52	50	51	54	50	42	59
	Descarga	34	51	55	61	62	61	57	50	67
8	Aspiración	27	42	47	46	48	50	47	40	55
	Descarga	30	48	52	57	59	57	53	47	64
9	Aspiración	23	38	44	45	48	49	46	39	54
	Descarga	27	44	49	56	59	57	52	45	63
10	Aspiración	28	41	48	46	47	50	46	38	55
	Descarga	30	47	51	57	58	57	53	46	63
11	Aspiración	23	38	43	42	44	46	43	36	52
	Descarga	26	44	48	53	55	53	49	43	60
12	Aspiración	19	34	40	41	44	45	42	35	51
	Descarga	23	40	45	52	55	53	48	41	59

Punto de trabajo		63	125	250	500	1.000	2.000	4.000	8.000	LwA
1	Aspiración	49	65	70	69	70	71	68	62	77
	Descarga	53	74	76	80	80	77	73	65	85
2	Aspiración	45	62	67	65	66	65	63	57	73
	Descarga	49	72	73	77	76	70	66	58	81
3	Aspiración	40	57	62	61	63	64	61	56	70
	Descarga	44	65	69	72	72	70	66	60	78
4	Aspiración	44	60	65	64	65	66	63	57	73
	Descarga	48	69	71	75	75	72	68	60	81
5	Aspiración	41	58	63	61	62	61	59	53	68
	Descarga	45	68	69	73	72	66	62	54	77
6	Aspiración	36	53	58	57	59	60	57	52	65
	Descarga	40	61	65	68	68	66	62	56	73
7	Aspiración	38	54	59	58	59	60	57	51	67
	Descarga	42	63	65	69	69	66	62	54	75
8	Aspiración	35	52	57	55	56	55	53	47	63
	Descarga	39	62	63	67	66	60	56	48	71
9	Aspiración	30	47	52	51	53	54	51	46	60
	Descarga	34	55	59	62	62	60	56	50	67
10	Aspiración	35	51	56	55	56	57	54	48	63
	Descarga	39	60	62	66	66	63	59	51	71
11	Aspiración	31	48	53	51	52	51	49	43	59
	Descarga	35	58	59	63	62	56	52	44	67
12	Aspiración	26	43	48	47	49	50	47	42	56
	Descarga	30	51	55	58	58	56	52	46	64

CURVAS CARACTERÍSTICAS - CARACTERÍSTICAS ACÚSTICAS CRHT 6 Polos

- q_v = Caudal en m^3/h .
- p_{sf} = Presión estática en mmcda y Pa.
- Potencia absorbida en W.
- SFP curvas azules en $W/m^3/s$.
- Aire seco normal a $20^\circ C$ y 760 mmHg.
- Ensayos realizados de acuerdo a Norma ISO 5801 y AMCA 210-99.

CRHT/6-630N

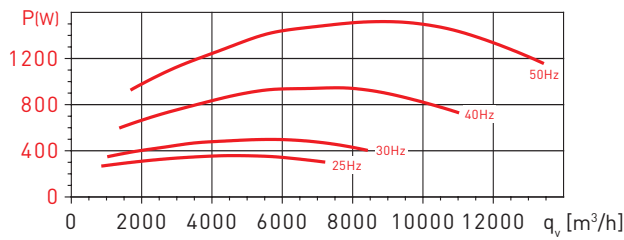
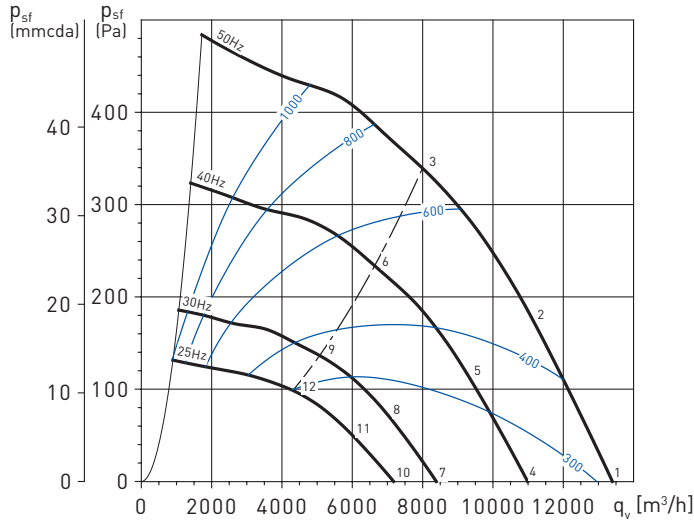

Punto de trabajo		63	125	250	500	1.000	2.000	4.000	8.000	LwA
1	Aspiración	53	69	74	71	73	75	67	62	80
	Descarga	57	73	78	83	82	81	74	68	88
2	Aspiración	49	66	70	67	69	68	64	58	76
	Descarga	52	69	75	79	78	75	70	64	84
3	Aspiración	46	62	66	63	67	66	62	56	73
	Descarga	49	64	70	75	77	75	70	64	81
4	Aspiración	49	65	70	67	69	71	63	58	76
	Descarga	53	69	74	79	78	77	70	64	83
5	Aspiración	45	62	66	63	65	64	60	54	71
	Descarga	48	65	71	75	74	71	66	60	79
6	Aspiración	42	58	62	59	63	62	58	52	69
	Descarga	45	60	66	71	73	71	66	60	77
7	Aspiración	43	59	64	61	63	65	57	52	70
	Descarga	47	63	68	73	72	71	64	58	78
8	Aspiración	39	56	60	57	59	58	54	48	66
	Descarga	42	59	65	69	68	65	60	54	74
9	Aspiración	36	52	56	53	57	56	52	46	63
	Descarga	39	54	60	65	67	65	60	54	72
10	Aspiración	39	55	60	57	59	61	53	48	66
	Descarga	43	59	64	69	68	67	60	54	74
11	Aspiración	35	52	56	53	55	54	50	44	62
	Descarga	38	55	61	65	64	61	56	50	70
12	Aspiración	32	48	52	49	53	52	48	42	59
	Descarga	35	50	56	61	63	61	56	50	68

CURVAS CARACTERÍSTICAS - CARACTERÍSTICAS ACÚSTICAS CRVB 2 Polos

- q_v = Caudal en m^3/h .
- p_{sf} = Presión estática en mmcda y Pa.
- Potencia absorbida en W.
- SFP curvas azules en $W/m^3/s$.
- Aire seco normal a $20^\circ C$ y 760 mmHg.
- Ensayos realizados de acuerdo a Norma ISO 5801 y AMCA 210-99.

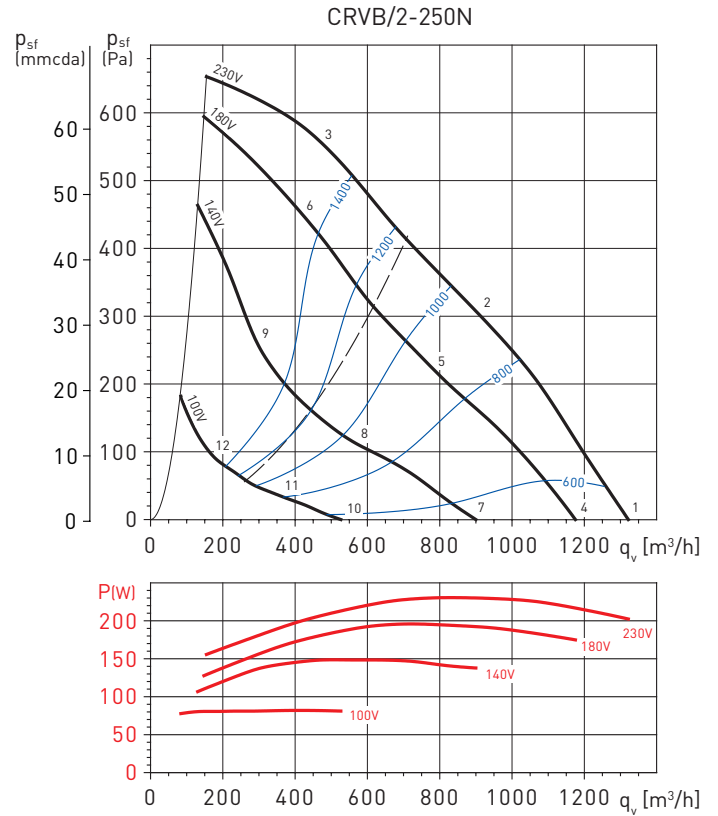
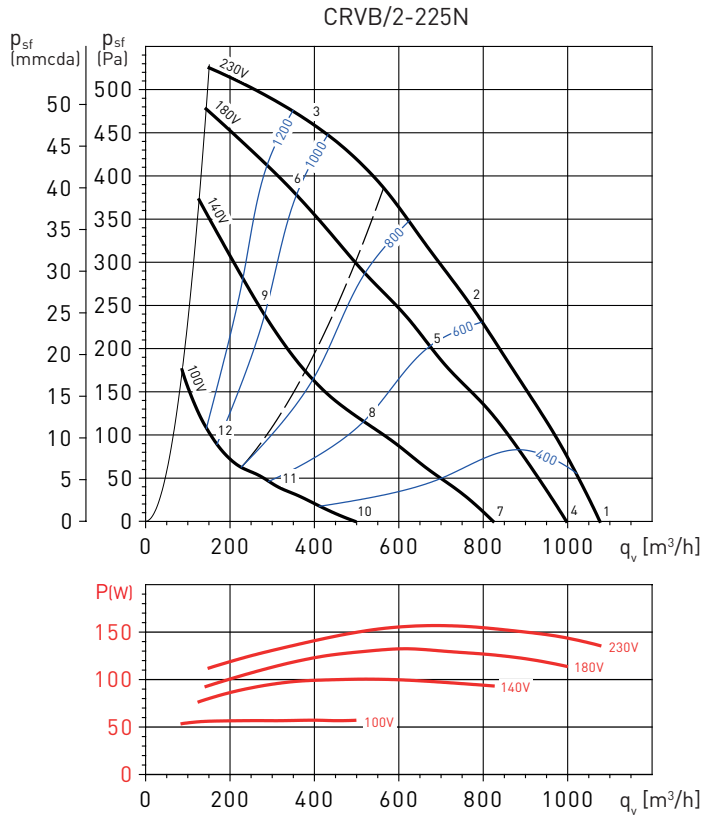

Punto de trabajo		63	125	250	500	1.000	2.000	4.000	8.000	LwA
1	Aspiración	35	48	61	67	70	69	69	62	75
	Descarga	37	48	62	70	74	74	71	64	79
2	Aspiración	32	39	55	60	60	60	61	53	67
	Descarga	32	40	61	64	66	66	62	55	71
3	Aspiración	35	46	58	62	60	61	59	53	67
	Descarga	35	47	61	64	68	68	62	57	73
4	Aspiración	33	46	59	65	68	67	67	60	74
	Descarga	35	46	60	68	72	72	69	62	77
5	Aspiración	29	36	52	57	57	57	58	50	64
	Descarga	29	37	58	61	63	63	59	52	69
6	Aspiración	33	44	56	60	58	59	57	51	65
	Descarga	33	45	59	62	66	66	60	55	71
7	Aspiración	29	42	55	61	64	63	63	56	69
	Descarga	31	42	56	64	68	68	65	58	73
8	Aspiración	23	30	46	51	51	51	52	44	58
	Descarga	23	31	52	55	57	57	53	46	63
9	Aspiración	28	39	51	55	53	54	52	46	60
	Descarga	28	40	54	57	61	61	55	50	66
10	Aspiración	18	31	44	50	53	52	52	45	58
	Descarga	20	31	45	53	57	57	54	47	62
11	Aspiración	13	20	36	41	41	41	42	34	47
	Descarga	13	21	42	45	47	47	43	36	52
12	Aspiración	17	28	40	44	42	43	41	35	50
	Descarga	17	29	43	46	50	50	44	39	55

Punto de trabajo		63	125	250	500	1.000	2.000	4.000	8.000	LwA
1	Aspiración	36	47	64	68	69	69	69	62	75
	Descarga	39	49	68	71	74	76	73	66	80
2	Aspiración	33	43	58	62	62	64	62	56	69
	Descarga	33	43	61	66	70	72	66	60	76
3	Aspiración	36	49	59	63	64	68	64	59	72
	Descarga	36	50	60	66	71	76	70	64	78
4	Aspiración	34	45	62	66	67	67	67	60	73
	Descarga	37	47	66	69	72	74	71	64	78
5	Aspiración	30	40	55	59	59	61	59	53	66
	Descarga	30	40	58	63	67	69	63	57	72
6	Aspiración	34	47	57	61	62	66	62	57	70
	Descarga	34	48	58	64	69	74	68	62	76
7	Aspiración	28	39	56	60	61	61	61	54	67
	Descarga	31	41	60	63	66	68	65	58	72
8	Aspiración	23	33	48	52	52	54	52	46	59
	Descarga	23	33	51	56	60	62	56	50	65
9	Aspiración	28	41	51	55	56	60	56	51	64
	Descarga	28	42	52	58	63	68	62	56	70
10	Aspiración	16	27	44	48	49	49	49	42	56
	Descarga	19	29	48	51	54	56	53	46	60
11	Aspiración	12	22	37	41	41	43	41	35	48
	Descarga	12	22	40	45	49	51	45	39	54
12	Aspiración	16	29	39	43	44	48	44	39	52
	Descarga	16	30	40	46	51	56	50	44	59

CURVAS CARACTERÍSTICAS - CARACTERÍSTICAS ACÚSTICAS CRVB 4 Polos

- q_v = Caudal en m^3/h .
- p_{sf} = Presión estática en mmca y Pa.
- Potencia absorbida en W.
- SFP curvas azules en $W/m^3/s$.
- Aire seco normal a $20^\circ C$ y 760 mmHg.
- Ensayos realizados de acuerdo a Norma ISO 5801 y AMCA 210-99.

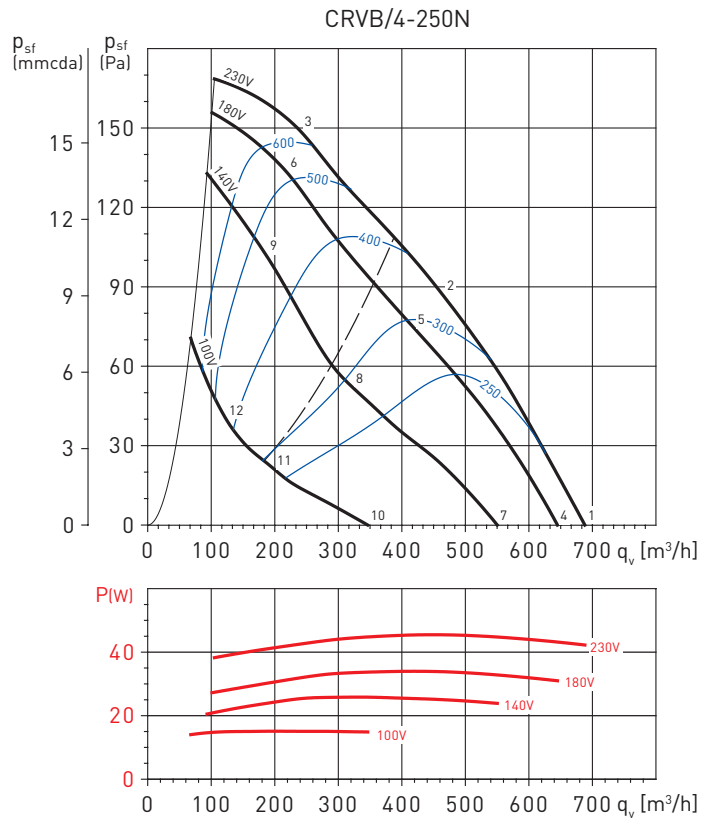
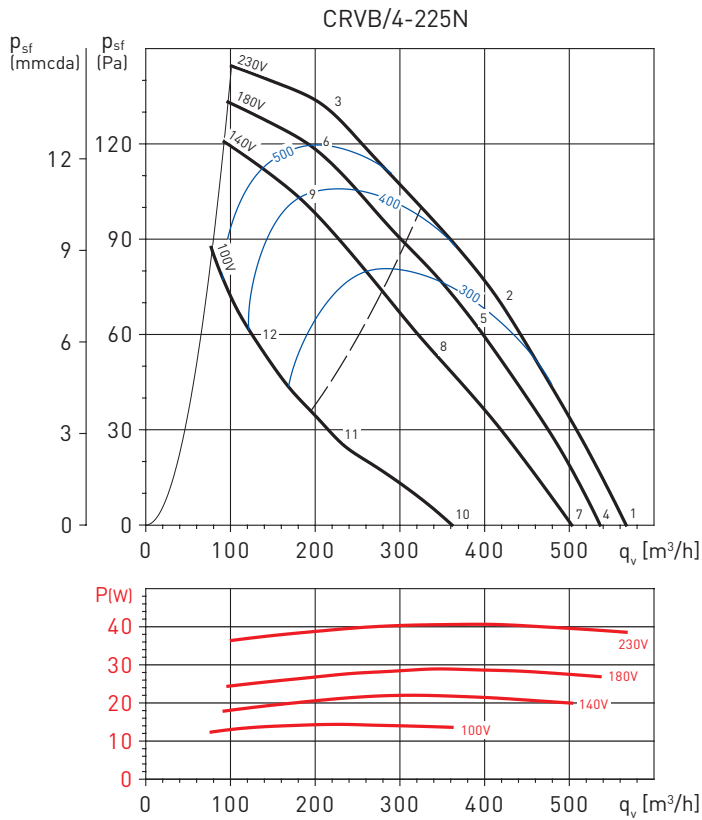

Punto de trabajo		63	125	250	500	1.000	2.000	4.000	8.000	LwA
1	Aspiración	27	42	46	51	55	56	48	37	60
	Descarga	27	44	48	54	58	61	49	38	64
2	Aspiración	25	42	43	45	47	49	43	35	53
	Descarga	25	42	46	50	52	55	42	35	58
3	Aspiración	35	43	45	46	47	45	40	33	53
	Descarga	27	43	46	51	54	51	41	34	58
4	Aspiración	26	41	45	50	54	55	47	36	59
	Descarga	26	43	47	53	57	60	48	37	63
5	Aspiración	24	41	42	44	46	48	42	34	53
	Descarga	24	41	45	49	51	54	41	34	57
6	Aspiración	34	42	44	45	46	44	39	32	52
	Descarga	26	42	45	50	53	50	40	33	57
7	Aspiración	25	40	44	49	53	54	46	35	58
	Descarga	25	42	46	52	56	59	47	36	61
8	Aspiración	22	39	40	42	44	46	40	32	50
	Descarga	22	39	43	47	49	52	39	32	55
9	Aspiración	33	41	43	44	45	43	38	31	50
	Descarga	25	41	44	49	52	49	39	32	55
10	Aspiración	18	33	37	42	46	47	39	28	51
	Descarga	18	35	39	45	49	52	40	29	55
11	Aspiración	14	31	32	34	36	38	32	24	43
	Descarga	14	31	35	39	41	44	31	24	47
12	Aspiración	26	34	36	37	38	36	31	24	44
	Descarga	18	34	37	42	45	42	32	25	49

Punto de trabajo		63	125	250	500	1.000	2.000	4.000	8.000	LwA
1	Aspiración	27	47	44	49	53	56	47	38	59
	Descarga	29	46	48	53	58	62	49	40	64
2	Aspiración	26	45	41	45	47	50	42	35	54
	Descarga	30	44	47	50	54	58	45	38	60
3	Aspiración	30	47	44	50	50	49	43	36	56
	Descarga	32	46	49	54	58	57	48	39	62
4	Aspiración	26	46	43	48	52	55	46	37	58
	Descarga	28	45	47	52	57	61	48	39	63
5	Aspiración	24	43	39	43	45	48	40	33	52
	Descarga	28	42	45	48	52	56	43	36	59
6	Aspiración	29	46	43	49	49	48	42	35	55
	Descarga	31	45	48	53	57	56	47	38	61
7	Aspiración	22	42	39	44	48	51	42	33	55
	Descarga	24	41	43	48	53	57	44	35	60
8	Aspiración	20	39	35	39	41	44	36	29	47
	Descarga	24	38	41	44	48	52	39	32	54
9	Aspiración	26	43	40	46	46	45	39	32	51
	Descarga	28	42	45	50	54	53	44	35	58
10	Aspiración	13	33	30	35	39	42	33	24	45
	Descarga	15	32	34	39	44	48	35	26	50
11	Aspiración	9	28	24	28	30	33	25	18	37
	Descarga	13	27	30	33	37	41	28	21	44
12	Aspiración	16	33	30	36	36	35	29	22	42
	Descarga	18	32	35	40	44	43	34	25	48

CURVAS CARACTERÍSTICAS - CARACTERÍSTICAS ACÚSTICAS CRVB 4 Polos

- q_v = Caudal en m^3/h .
- p_{sf} = Presión estática en mmcda y Pa.
- Potencia absorbida en W.
- SFP curvas azules en $W/m^3/s$.
- Aire seco normal a $20^\circ C$ y 760 mmHg.
- Ensayos realizados de acuerdo a Norma ISO 5801 y AMCA 210-99.

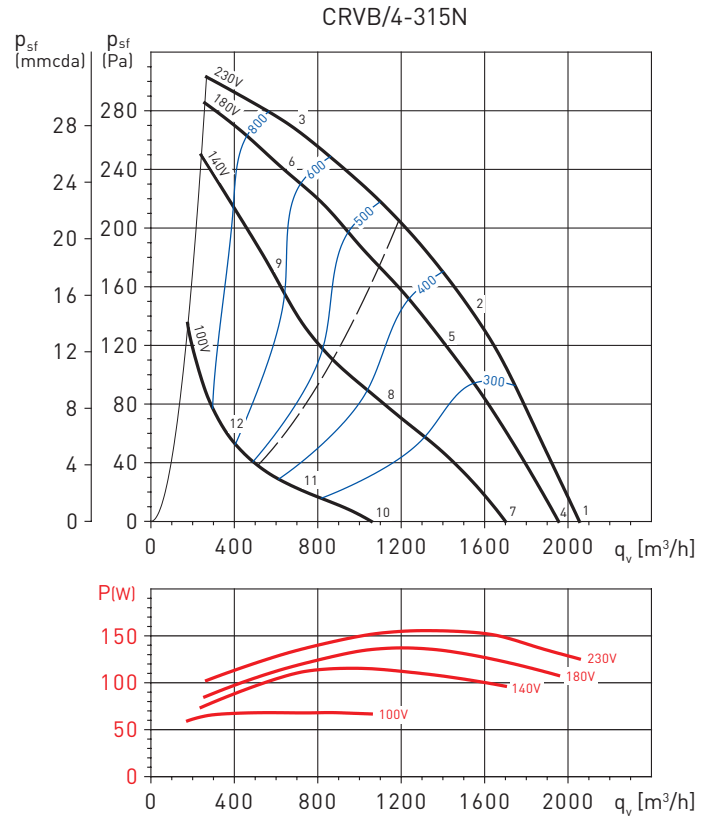
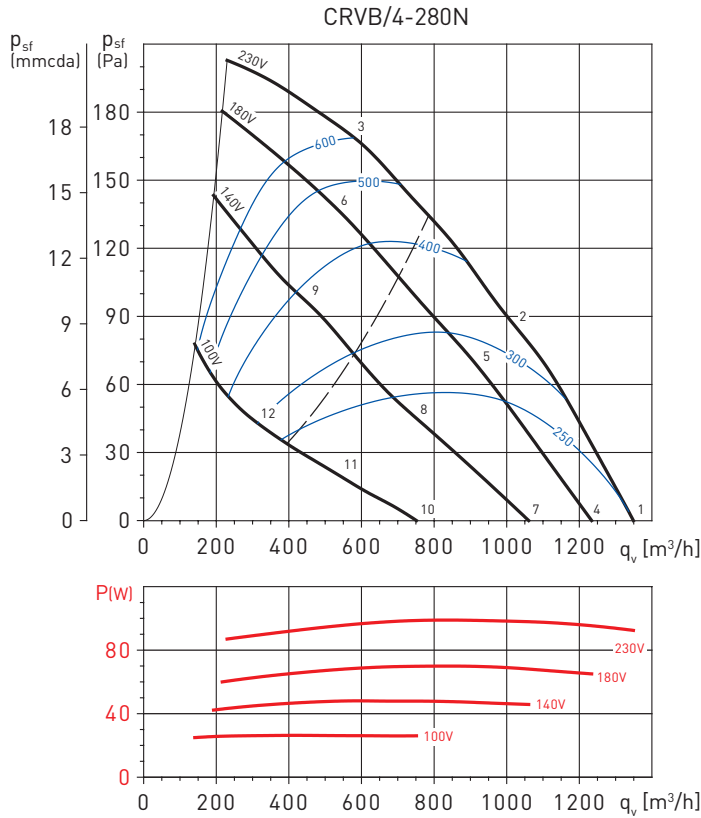

Punto de trabajo		63	125	250	500	1.000	2.000	4.000	8.000	LwA
1	Aspiración	37	49	53	57	61	65	54	42	67
	Descarga	43	53	54	62	66	65	54	43	70
2	Aspiración	37	48	52	55	53	53	48	38	60
	Descarga	43	52	52	60	62	58	50	39	66
3	Aspiración	41	49	54	56	52	52	47	39	60
	Descarga	43	51	53	61	62	59	51	42	66
4	Aspiración	35	47	51	55	59	63	52	40	65
	Descarga	41	51	52	60	64	63	52	41	68
5	Aspiración	35	46	50	53	51	51	46	36	58
	Descarga	41	50	50	58	60	56	48	37	63
6	Aspiración	39	47	52	54	50	50	45	37	58
	Descarga	41	49	51	59	60	57	49	40	64
7	Aspiración	32	44	48	52	56	60	49	37	62
	Descarga	38	48	49	57	61	60	49	38	65
8	Aspiración	30	41	45	48	46	46	41	31	53
	Descarga	36	45	45	53	55	51	43	32	59
9	Aspiración	35	43	48	50	46	46	41	33	55
	Descarga	37	45	47	55	56	53	45	36	60
10	Aspiración	24	36	40	44	48	52	41	29	55
	Descarga	30	40	41	49	53	52	41	30	57
11	Aspiración	22	33	37	40	38	38	33	23	45
	Descarga	28	37	37	45	47	43	35	24	51
12	Aspiración	27	35	40	42	38	38	33	25	46
	Descarga	29	37	39	47	48	45	37	28	52

Punto de trabajo		63	125	250	500	1.000	2.000	4.000	8.000	LwA
1	Aspiración	42	55	62	63	64	62	64	49	70
	Descarga	41	60	66	69	70	68	66	52	75
2	Aspiración	35	50	57	58	60	59	56	44	65
	Descarga	36	55	62	64	66	64	58	47	71
3	Aspiración	41	51	59	59	60	57	52	43	65
	Descarga	42	55	60	63	68	64	57	48	71
4	Aspiración	41	54	61	62	63	61	63	48	69
	Descarga	40	59	65	68	69	67	65	51	74
5	Aspiración	33	48	55	56	58	57	54	42	64
	Descarga	34	53	60	62	64	62	56	45	69
6	Aspiración	40	50	58	58	59	56	51	42	64
	Descarga	41	54	59	62	67	63	56	47	70
7	Aspiración	38	51	58	59	60	58	60	45	66
	Descarga	37	56	62	65	66	64	62	48	71
8	Aspiración	28	43	50	51	53	52	49	37	59
	Descarga	29	48	55	57	59	57	51	40	64
9	Aspiración	36	46	54	54	55	52	47	38	60
	Descarga	37	50	55	58	63	59	52	43	66
10	Aspiración	28	41	48	49	50	48	50	35	56
	Descarga	27	46	52	55	56	54	52	38	61
11	Aspiración	17	32	39	40	42	41	38	26	47
	Descarga	18	37	44	46	48	46	40	29	52
12	Aspiración	25	35	43	43	44	41	36	27	49
	Descarga	26	39	44	47	52	48	41	32	55

CURVAS CARACTERÍSTICAS - CARACTERÍSTICAS ACÚSTICAS CRVB 4 Polos

- q_v = Caudal en m^3/h .
- p_{sf} = Presión estática en mmcda y Pa.
- Potencia absorbida en W.
- SFP curvas azules en $W/m^3/s$.
- Aire seco normal a $20^\circ C$ y 760 mmHg.
- Ensayos realizados de acuerdo a Norma ISO 5801 y AMCA 210-99.

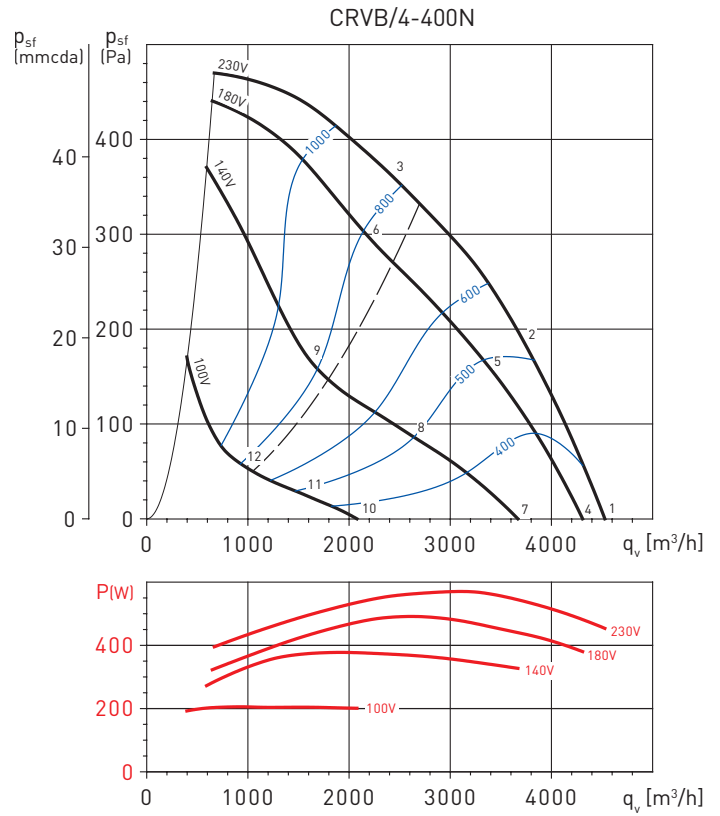
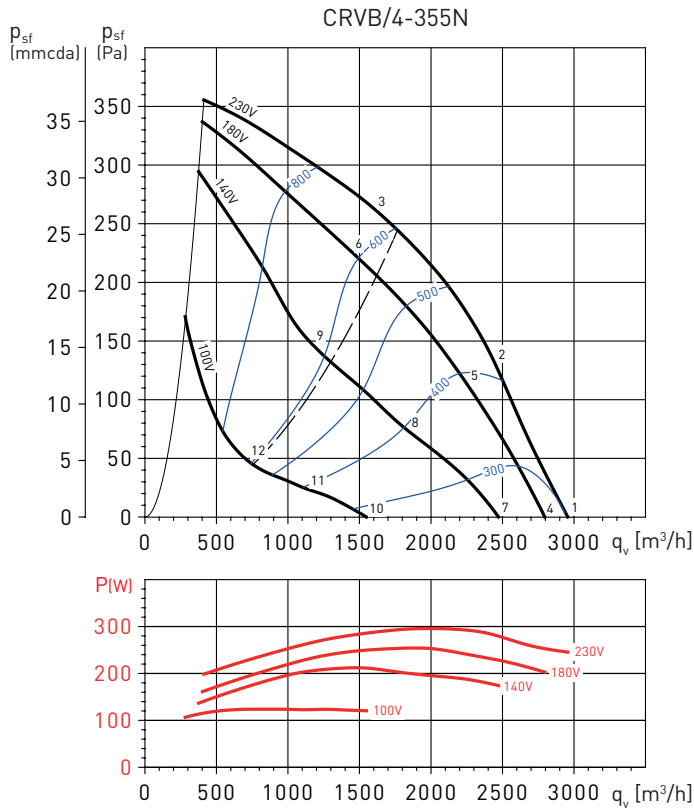

Punto de trabajo		63	125	250	500	1.000	2.000	4.000	8.000	LwA
1	Aspiración	45	56	65	66	65	64	62	53	72
	Descarga	45	61	68	71	74	70	66	57	78
2	Aspiración	41	53	61	61	62	62	59	50	68
	Descarga	41	58	64	67	70	67	63	54	74
3	Aspiración	35	48	58	58	61	60	56	48	66
	Descarga	36	56	61	65	70	66	61	52	73
4	Aspiración	44	55	64	65	64	63	61	52	71
	Descarga	44	60	67	70	73	69	65	56	77
5	Aspiración	39	51	59	59	60	60	57	48	67
	Descarga	39	56	62	65	68	65	61	52	72
6	Aspiración	33	46	56	56	59	58	54	46	64
	Descarga	34	54	59	63	68	64	59	50	71
7	Aspiración	41	52	61	62	61	60	58	49	68
	Descarga	41	57	64	67	70	66	62	53	74
8	Aspiración	35	47	55	55	56	56	53	44	62
	Descarga	35	52	58	61	64	61	57	48	68
9	Aspiración	29	42	52	52	55	54	50	42	60
	Descarga	30	50	55	59	64	60	55	46	67
10	Aspiración	31	42	51	52	51	50	48	39	58
	Descarga	31	47	54	57	60	56	52	43	64
11	Aspiración	24	36	44	44	45	45	42	33	51
	Descarga	24	41	47	50	53	50	46	37	57
12	Aspiración	17	30	40	40	43	42	38	30	48
	Descarga	18	38	43	47	52	48	43	34	55

Punto de trabajo		63	125	250	500	1.000	2.000	4.000	8.000	LwA
1	Aspiración	40	61	66	69	69	71	68	58	76
	Descarga	43	66	70	74	75	74	71	61	80
2	Aspiración	37	56	62	64	66	68	64	56	72
	Descarga	40	65	66	69	72	70	67	59	77
3	Aspiración	37	52	60	61	65	65	62	55	70
	Descarga	39	60	64	67	71	69	65	58	75
4	Aspiración	39	60	65	68	68	70	67	57	75
	Descarga	42	65	69	73	74	73	70	60	79
5	Aspiración	35	54	60	62	64	66	62	54	71
	Descarga	38	63	64	67	70	68	65	57	75
6	Aspiración	35	50	58	59	63	63	60	53	68
	Descarga	37	58	62	65	69	67	63	56	73
7	Aspiración	35	56	61	64	64	66	63	53	72
	Descarga	38	61	65	69	70	69	66	56	76
8	Aspiración	29	48	54	56	58	60	56	48	65
	Descarga	32	57	58	61	64	62	59	51	69
9	Aspiración	29	44	52	53	57	57	54	47	62
	Descarga	31	52	56	59	63	61	57	50	67
10	Aspiración	23	44	49	52	52	54	51	41	59
	Descarga	26	49	53	57	58	57	54	44	64
11	Aspiración	17	36	42	44	46	48	44	36	53
	Descarga	20	45	46	49	52	50	47	39	57
12	Aspiración	17	32	40	41	45	45	42	35	50
	Descarga	19	40	44	47	51	49	45	38	55

CURVAS CARACTERÍSTICAS - CARACTERÍSTICAS ACÚSTICAS CRVB 4 Polos

- q_v = Caudal en m^3/h .
- p_{sf} = Presión estática en mmcda y Pa.
- Potencia absorbida en W.
- SFP curvas azules en $W/m^3/s$.
- Aire seco normal a $20^\circ C$ y 760 mmHg.
- Ensayos realizados de acuerdo a Norma ISO 5801 y AMCA 210-99.

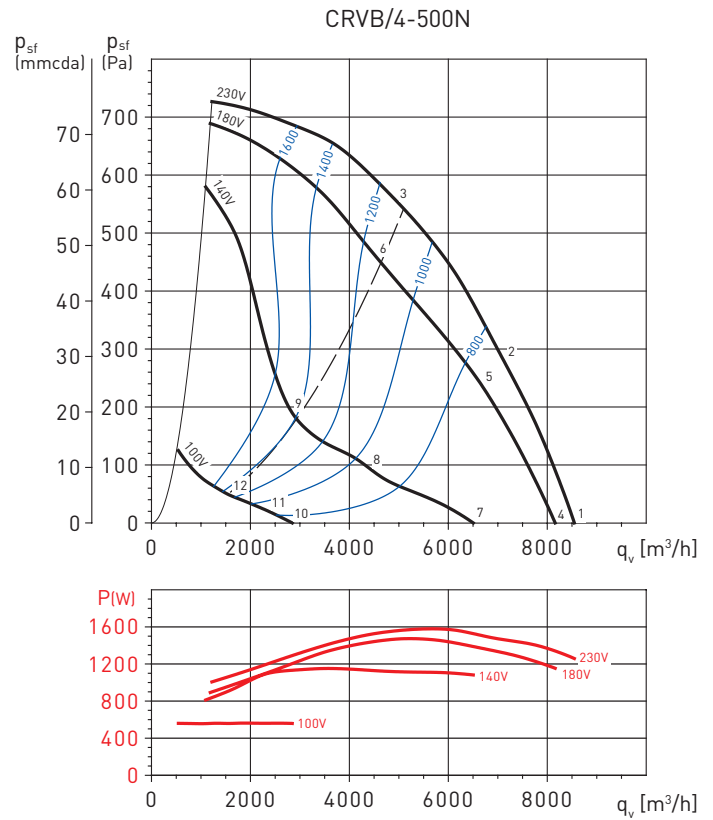
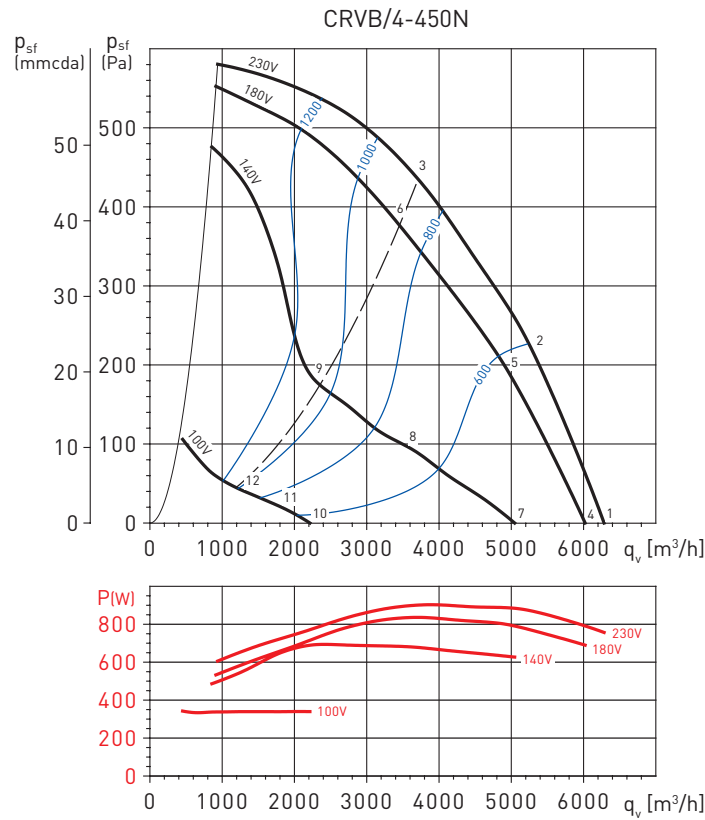

Punto de trabajo		63	125	250	500	1.000	2.000	4.000	8.000	LwA
1	Aspiración	49	65	73	76	75	74	73	65	82
	Descarga	53	71	75	79	83	79	76	69	87
2	Aspiración	46	63	69	72	71	72	69	62	78
	Descarga	48	69	71	74	79	76	73	67	83
3	Aspiración	41	58	65	67	69	71	67	61	76
	Descarga	42	63	66	70	77	77	73	68	82
4	Aspiración	48	64	72	75	74	73	72	64	81
	Descarga	52	70	74	78	82	78	75	68	86
5	Aspiración	45	62	68	71	70	71	68	61	77
	Descarga	47	68	70	73	78	75	72	66	81
6	Aspiración	39	56	63	65	67	69	65	59	74
	Descarga	40	61	64	68	75	75	71	66	80
7	Aspiración	44	60	68	71	70	69	68	60	77
	Descarga	48	66	70	74	78	74	71	64	82
8	Aspiración	37	54	60	63	62	63	60	53	69
	Descarga	39	60	62	65	70	67	64	58	74
9	Aspiración	32	49	56	58	60	62	58	52	66
	Descarga	33	54	57	61	68	68	64	59	72
10	Aspiración	27	43	51	54	53	52	51	43	59
	Descarga	31	49	53	57	61	57	54	47	64
11	Aspiración	22	39	45	48	47	48	45	38	54
	Descarga	24	45	47	50	55	52	49	43	59
12	Aspiración	17	34	41	43	45	47	43	37	51
	Descarga	18	39	42	46	53	53	49	44	57

Punto de trabajo		63	125	250	500	1.000	2.000	4.000	8.000	LwA
1	Aspiración	52	71	77	78	78	77	75	72	85
	Descarga	56	72	77	82	84	82	79	75	89
2	Aspiración	50	68	73	73	74	74	72	67	81
	Descarga	52	69	73	77	80	78	75	70	85
3	Aspiración	45	64	67	68	73	74	71	66	79
	Descarga	48	65	68	73	78	79	75	70	83
4	Aspiración	51	70	76	77	77	76	74	71	84
	Descarga	55	71	76	81	83	81	78	74	88
5	Aspiración	48	66	71	71	72	72	70	65	79
	Descarga	50	67	71	75	78	76	73	68	83
6	Aspiración	43	62	65	66	71	72	69	64	77
	Descarga	46	63	66	71	76	77	73	68	81
7	Aspiración	46	65	71	72	72	71	69	66	78
	Descarga	50	66	71	76	78	76	73	69	82
8	Aspiración	39	57	62	62	63	63	61	56	70
	Descarga	41	58	62	66	69	67	64	59	73
9	Aspiración	34	53	56	57	62	63	60	55	67
	Descarga	37	54	57	62	67	68	64	59	72
10	Aspiración	28	47	53	54	54	53	51	48	60
	Descarga	32	48	53	58	60	58	55	51	65
11	Aspiración	24	42	47	47	48	48	46	41	55
	Descarga	26	43	47	51	54	52	49	44	59
12	Aspiración	19	38	41	42	47	48	45	40	53
	Descarga	22	39	42	47	52	53	49	44	58

CURVAS CARACTERÍSTICAS - CARACTERÍSTICAS ACÚSTICAS CRVB 6 Polos

- q_v = Caudal en m^3/h .
- p_{sf} = Presión estática en mmca y Pa.
- Potencia absorbida en W.
- SFP curvas azules en $W/m^3/s$.
- Aire seco normal a $20^\circ C$ y 760 mmHg.
- Ensayos realizados de acuerdo a Norma ISO 5801 y AMCA 210-99.

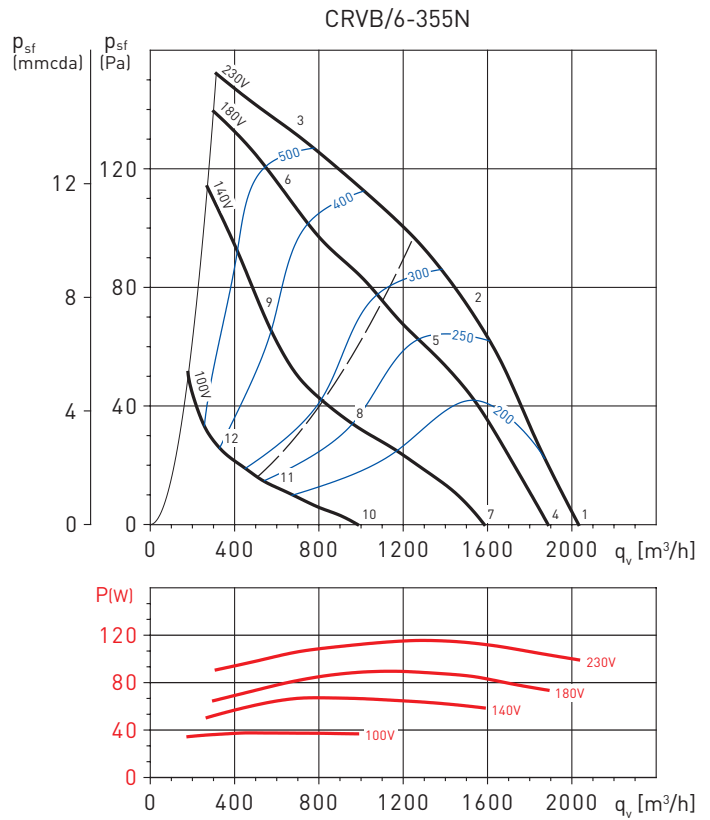
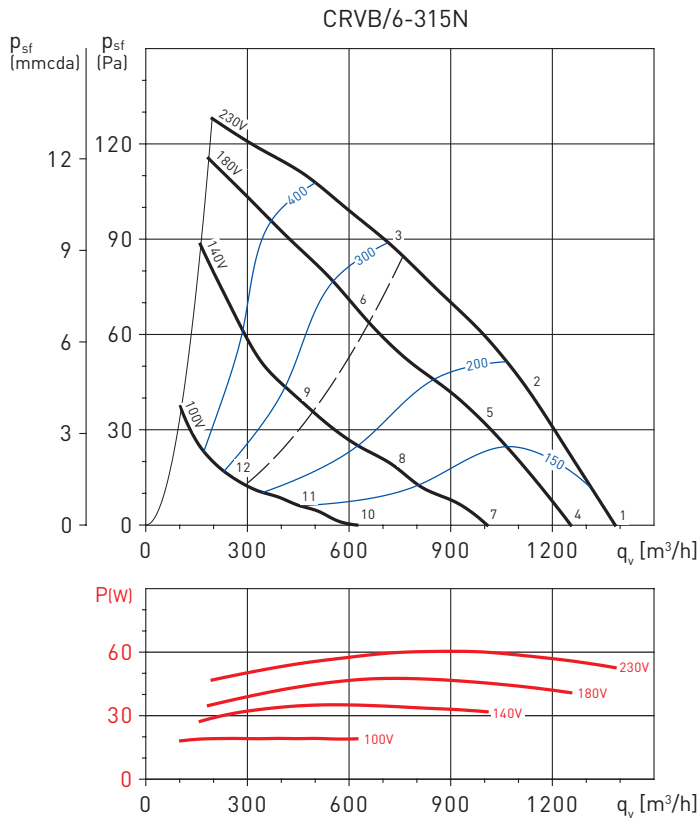

Punto de trabajo		63	125	250	500	1.000	2.000	4.000	8.000	LwA
1	Aspiración	34	44	50	50	51	54	43	33	58
	Descarga	34	50	54	56	58	61	47	37	64
2	Aspiración	30	41	48	47	48	49	39	30	54
	Descarga	30	49	53	54	56	55	42	33	61
3	Aspiración	29	38	47	45	45	42	34	28	52
	Descarga	29	48	49	51	53	47	37	30	58
4	Aspiración	32	42	48	48	49	52	41	31	56
	Descarga	32	48	52	54	56	59	45	35	62
5	Aspiración	27	38	45	44	45	46	36	27	51
	Descarga	27	46	50	51	53	52	39	30	58
6	Aspiración	26	35	44	42	42	39	31	25	49
	Descarga	26	45	46	48	50	44	34	27	55
7	Aspiración	27	37	43	43	44	47	36	26	51
	Descarga	27	43	47	49	51	54	40	30	58
8	Aspiración	21	32	39	38	39	40	30	21	45
	Descarga	21	40	44	45	47	46	33	24	52
9	Aspiración	20	29	38	36	36	33	25	19	42
	Descarga	20	39	40	42	44	38	28	21	48
10	Aspiración	17	27	33	33	34	37	26	16	41
	Descarga	17	33	37	39	41	44	30	20	47
11	Aspiración	10	21	28	27	28	29	19	10	34
	Descarga	10	29	33	34	36	35	22	13	41
12	Aspiración	9	18	27	25	25	22	14	8	32
	Descarga	9	28	29	31	33	27	17	10	37

Punto de trabajo		63	125	250	500	1.000	2.000	4.000	8.000	LwA
1	Aspiración	36	44	51	52	53	57	48	37	60
	Descarga	36	50	55	58	61	61	51	40	66
2	Aspiración	31	40	48	48	50	53	45	36	57
	Descarga	32	47	52	54	59	56	48	38	62
3	Aspiración	35	42	48	49	52	50	43	35	56
	Descarga	35	46	51	54	61	55	48	39	63
4	Aspiración	35	43	50	51	52	56	47	36	59
	Descarga	35	49	54	57	60	60	50	39	64
5	Aspiración	29	38	46	46	48	51	43	34	54
	Descarga	30	45	50	52	57	54	46	36	60
6	Aspiración	33	40	46	47	50	48	41	33	54
	Descarga	33	44	49	52	59	53	46	37	61
7	Aspiración	31	39	46	47	48	52	43	32	55
	Descarga	31	45	50	53	56	56	46	35	60
8	Aspiración	23	32	40	40	42	45	37	28	49
	Descarga	24	39	44	46	51	48	40	30	54
9	Aspiración	28	35	41	42	45	43	36	28	49
	Descarga	28	39	44	47	54	48	41	32	56
10	Aspiración	21	29	36	37	38	42	33	22	45
	Descarga	21	35	40	43	46	46	36	25	50
11	Aspiración	12	21	29	29	31	34	26	17	38
	Descarga	13	28	33	35	40	37	29	19	43
12	Aspiración	17	24	30	31	34	32	25	17	38
	Descarga	17	28	33	36	43	37	30	21	45

CURVAS CARACTERÍSTICAS - CARACTERÍSTICAS ACÚSTICAS CRVB 6 Polos

- q_v = Caudal en m^3/h .
- p_{sf} = Presión estática en mmcda y Pa.
- Potencia absorbida en W.
- SFP curvas azules en $W/m^3/s$.
- Aire seco normal a $20^\circ C$ y 760 mmHg.
- Ensayos realizados de acuerdo a Norma ISO 5801 y AMCA 210-99.

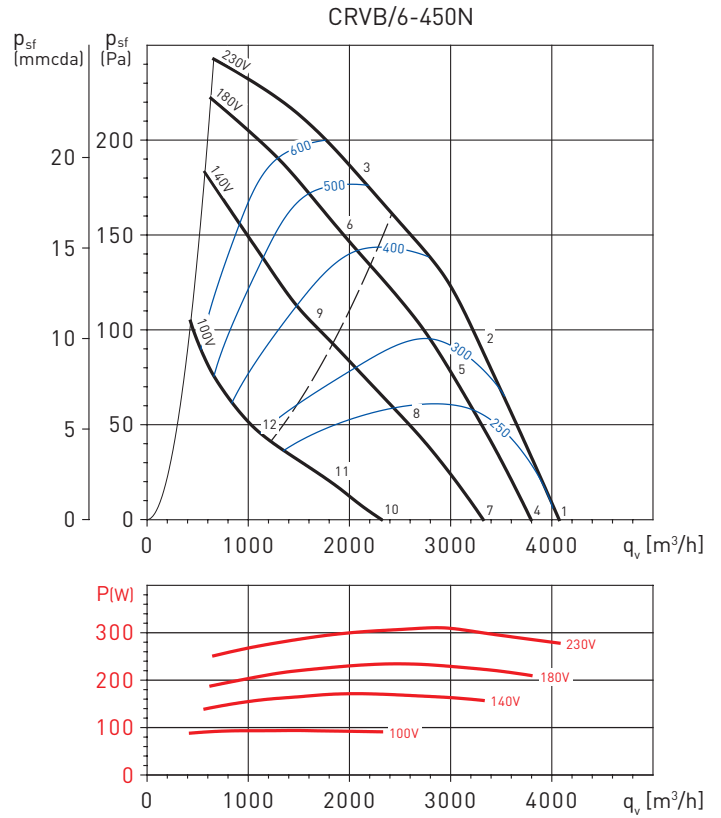
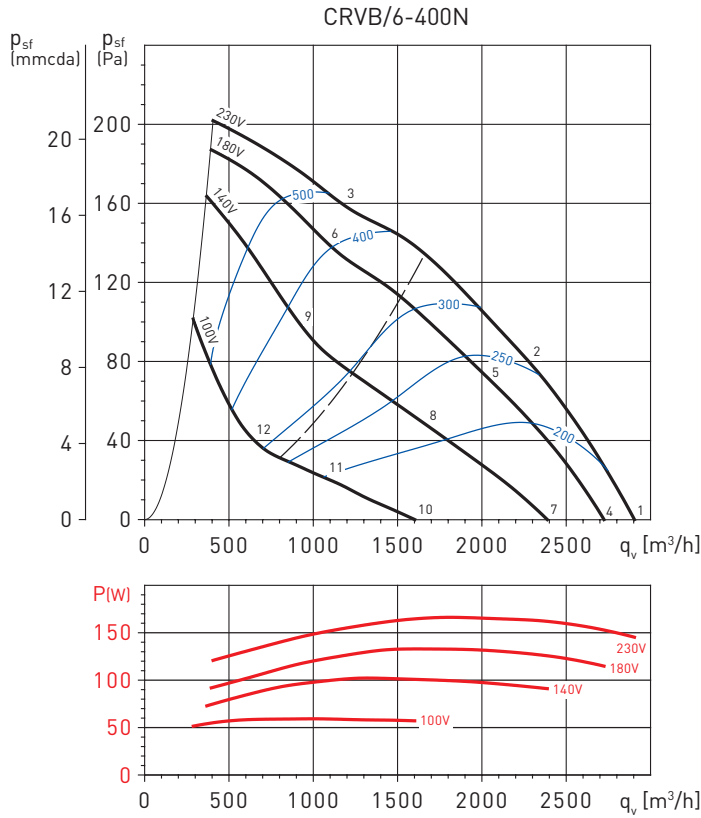

Punto de trabajo		63	125	250	500	1.000	2.000	4.000	8.000	LwA
1	Aspiración	35	46	55	58	65	63	51	41	68
	Descarga	37	53	58	61	66	65	53	44	70
2	Aspiración	31	44	51	55	61	54	46	36	63
	Descarga	31	49	55	59	63	57	49	39	66
3	Aspiración	38	45	52	55	55	50	45	37	60
	Descarga	36	50	55	59	63	57	51	41	66
4	Aspiración	34	45	54	57	64	62	50	40	67
	Descarga	36	52	57	60	65	64	52	43	68
5	Aspiración	29	42	49	53	59	52	44	34	61
	Descarga	29	47	53	57	61	55	47	37	64
6	Aspiración	36	43	50	53	53	48	43	35	58
	Descarga	34	48	53	57	61	55	49	39	64
7	Aspiración	31	42	51	54	61	59	47	37	64
	Descarga	33	49	54	57	62	61	49	40	65
8	Aspiración	25	38	45	49	55	48	40	30	57
	Descarga	25	43	49	53	57	51	43	33	60
9	Aspiración	33	40	47	50	50	45	40	32	54
	Descarga	31	45	50	54	58	52	46	36	60
10	Aspiración	23	34	43	46	53	51	39	29	56
	Descarga	25	41	46	49	54	53	41	32	58
11	Aspiración	16	29	36	40	46	39	31	21	48
	Descarga	16	34	40	44	48	42	34	24	51
12	Aspiración	24	31	38	41	41	36	31	23	46
	Descarga	22	36	41	45	49	43	37	27	52

Punto de trabajo		63	125	250	500	1.000	2.000	4.000	8.000	LwA
1	Aspiración	37	52	58	60	65	67	57	48	70
	Descarga	40	56	62	65	70	68	61	53	74
2	Aspiración	34	50	55	57	63	61	54	45	66
	Descarga	36	53	60	62	67	64	57	48	70
3	Aspiración	32	46	53	56	59	58	53	45	64
	Descarga	34	52	58	61	67	63	57	49	70
4	Aspiración	36	51	57	59	64	66	56	47	69
	Descarga	39	55	61	64	69	67	60	52	72
5	Aspiración	32	48	53	55	61	59	52	43	65
	Descarga	34	51	58	60	65	62	55	46	68
6	Aspiración	30	44	51	54	57	56	51	43	62
	Descarga	32	50	56	59	65	61	55	47	68
7	Aspiración	33	48	54	56	61	63	53	44	66
	Descarga	36	52	58	61	66	64	57	49	69
8	Aspiración	28	44	49	51	57	55	48	39	61
	Descarga	30	47	54	56	61	58	51	42	65
9	Aspiración	26	40	47	50	53	52	47	39	58
	Descarga	28	46	52	55	61	57	51	43	64
10	Aspiración	25	40	46	48	53	55	45	36	58
	Descarga	28	44	50	53	58	56	49	41	62
11	Aspiración	20	36	41	43	49	47	40	31	52
	Descarga	22	39	46	48	53	50	43	34	56
12	Aspiración	17	31	38	41	44	43	38	30	49
	Descarga	19	37	43	46	52	48	42	34	55

CURVAS CARACTERÍSTICAS - CARACTERÍSTICAS ACÚSTICAS CRVB 6 Polos

- q_v = Caudal en m^3/h .
- p_{sf} = Presión estática en mmcda y Pa.
- Potencia absorbida en W.
- SFP curvas azules en $W/m^3/s$.
- Aire seco normal a $20^\circ C$ y 760 mmHg.
- Ensayos realizados de acuerdo a Norma ISO 5801 y AMCA 210-99.

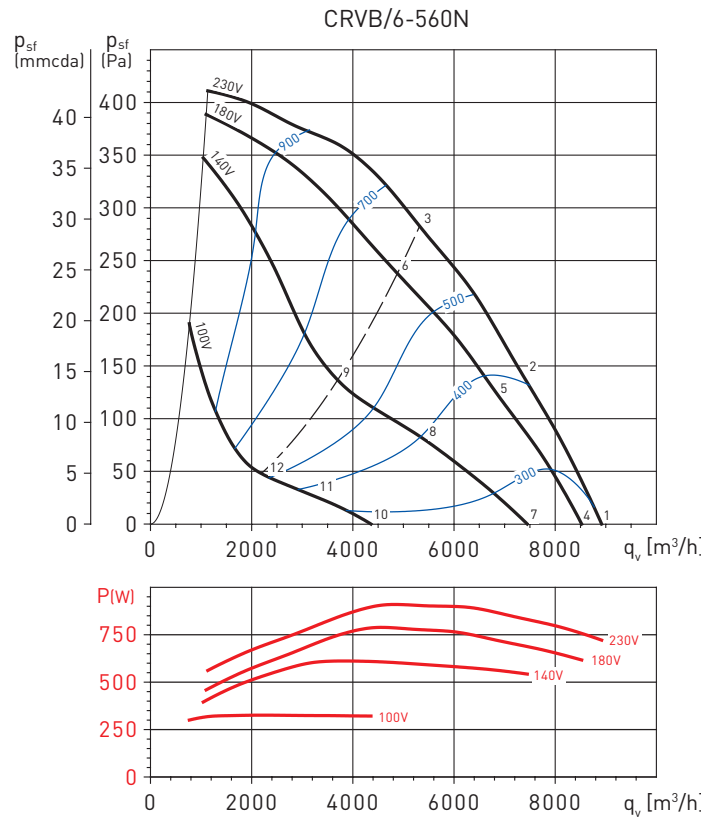
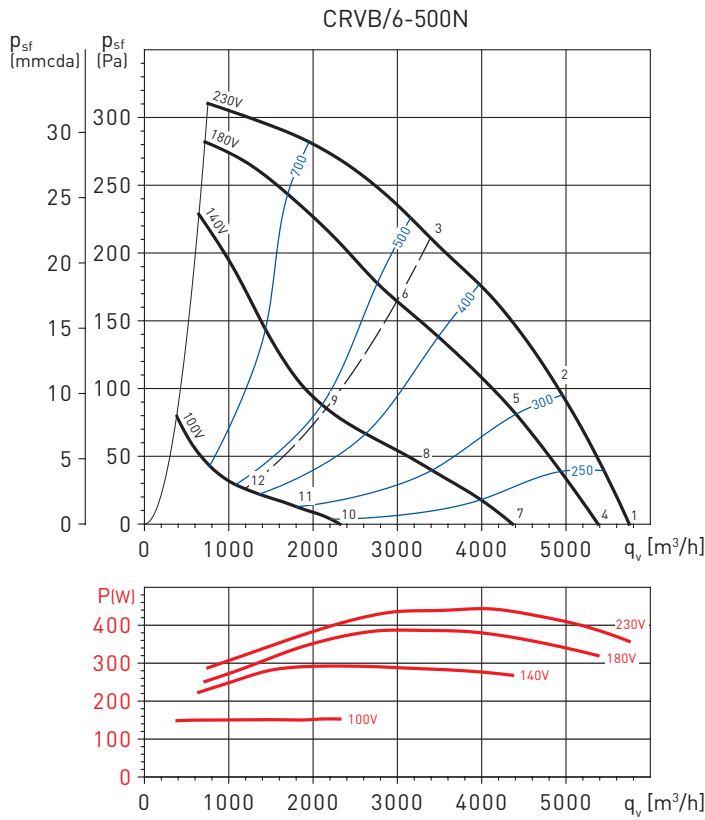

Punto de trabajo		63	125	250	500	1.000	2.000	4.000	8.000	LwA
1	Aspiración	44	56	63	63	65	66	63	54	71
	Descarga	46	61	66	69	71	70	65	56	76
2	Aspiración	40	53	59	60	62	63	60	52	68
	Descarga	44	59	62	65	69	67	62	54	73
3	Aspiración	37	51	56	59	62	62	58	51	67
	Descarga	43	58	57	64	69	67	61	54	73
4	Aspiración	42	54	61	61	63	64	61	52	70
	Descarga	44	59	64	67	69	68	63	54	74
5	Aspiración	38	51	57	58	60	61	58	50	66
	Descarga	42	57	60	63	67	65	60	52	71
6	Aspiración	34	48	53	56	59	59	55	48	64
	Descarga	40	55	54	61	66	64	58	51	70
7	Aspiración	38	50	57	57	59	60	57	48	65
	Descarga	40	55	60	63	65	64	59	50	70
8	Aspiración	31	44	50	51	53	54	51	43	60
	Descarga	35	50	53	56	60	58	53	45	64
9	Aspiración	27	41	46	49	52	52	48	41	57
	Descarga	33	48	47	54	59	57	51	44	63
10	Aspiración	24	36	43	43	45	46	43	34	52
	Descarga	26	41	46	49	51	50	45	36	56
11	Aspiración	18	31	37	38	40	41	38	30	46
	Descarga	22	37	40	43	47	45	40	32	51
12	Aspiración	14	28	33	36	39	39	35	28	44
	Descarga	20	35	34	41	46	44	38	31	50

Punto de trabajo		63	125	250	500	1.000	2.000	4.000	8.000	LwA
1	Aspiración	48	65	69	70	69	71	65	62	77
	Descarga	52	72	74	75	77	73	67	65	82
2	Aspiración	46	62	66	67	66	66	61	54	73
	Descarga	47	69	71	73	74	69	64	59	79
3	Aspiración	40	58	61	64	67	64	60	55	71
	Descarga	42	64	67	69	71	68	64	59	76
4	Aspiración	47	64	68	69	68	70	64	61	76
	Descarga	51	71	73	74	76	72	66	64	81
5	Aspiración	45	61	65	66	65	65	60	53	72
	Descarga	46	68	70	72	73	68	63	58	77
6	Aspiración	38	56	59	62	65	62	58	53	69
	Descarga	40	62	65	67	69	66	62	57	74
7	Aspiración	44	61	65	66	65	67	61	58	72
	Descarga	48	68	70	71	73	69	63	61	77
8	Aspiración	40	56	60	61	60	60	55	48	67
	Descarga	41	63	65	67	68	63	58	53	72
9	Aspiración	32	50	53	56	59	56	52	47	63
	Descarga	34	56	59	61	63	60	56	51	68
10	Aspiración	32	49	53	54	53	55	49	46	61
	Descarga	36	56	58	59	61	57	51	49	66
11	Aspiración	28	44	48	49	48	48	43	36	55
	Descarga	29	51	53	55	56	51	46	41	61
12	Aspiración	21	39	42	45	48	45	41	36	52
	Descarga	23	45	48	50	52	49	45	40	56

CURVAS CARACTERÍSTICAS - CARACTERÍSTICAS ACÚSTICAS CRVB 6 Polos

- q_v = Caudal en m^3/h .
- p_{sf} = Presión estática en mmcda y Pa.
- Potencia absorbida en W.
- SFP curvas azules en $W/m^3/s$.
- Aire seco normal a $20^\circ C$ y 760 mmHg.
- Ensayos realizados de acuerdo a Norma ISO 5801 y AMCA 210-99.

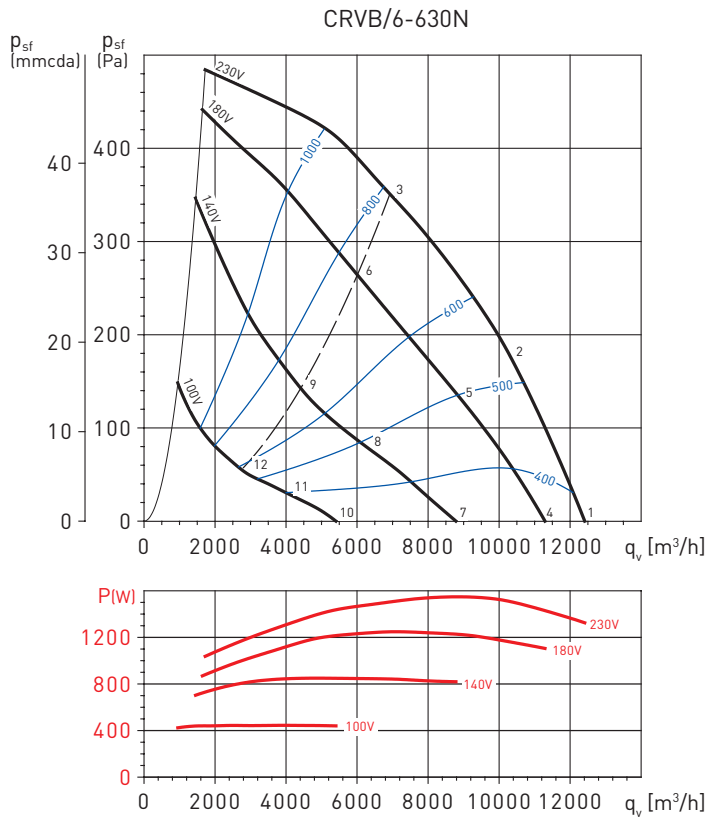

Punto de trabajo		63	125	250	500	1.000	2.000	4.000	8.000	LwA
1	Aspiración	53	67	73	72	74	73	68	63	80
	Descarga	57	75	78	79	79	78	72	67	85
2	Aspiración	49	65	70	68	70	68	64	59	76
	Descarga	52	73	76	75	76	73	69	64	82
3	Aspiración	49	62	68	67	69	69	65	59	75
	Descarga	49	67	74	74	75	75	70	65	81
4	Aspiración	51	65	71	70	72	71	66	61	78
	Descarga	55	73	76	77	77	76	70	65	83
5	Aspiración	46	62	67	65	67	65	61	56	73
	Descarga	49	70	73	72	73	70	66	61	79
6	Aspiración	46	59	65	64	66	66	62	56	72
	Descarga	46	64	71	71	72	72	67	62	78
7	Aspiración	45	59	65	64	66	65	60	55	72
	Descarga	49	67	70	71	71	70	64	59	78
8	Aspiración	40	56	61	59	61	59	55	50	66
	Descarga	43	64	67	66	67	64	60	55	73
9	Aspiración	39	52	58	57	59	59	55	49	65
	Descarga	39	57	64	64	65	65	60	55	71
10	Aspiración	35	49	55	54	56	55	50	45	62
	Descarga	39	57	60	61	61	60	54	49	67
11	Aspiración	29	45	50	48	50	48	44	39	56
	Descarga	32	53	56	55	56	53	49	44	63
12	Aspiración	29	42	48	47	49	49	45	39	55
	Descarga	29	47	54	54	55	55	50	45	61

CURVAS CARACTERÍSTICAS - CARACTERÍSTICAS ACÚSTICAS CRVT 4 Polos

- q_v = Caudal en m^3/h .
- p_{sf} = Presión estática en mmcda y Pa.
- Potencia absorbida en W.
- SFP curvas azules en $W/m^3/s$.
- Aire seco normal a $20^\circ C$ y 760 mmHg.
- Ensayos realizados de acuerdo a Norma ISO 5801 y AMCA 210-99.

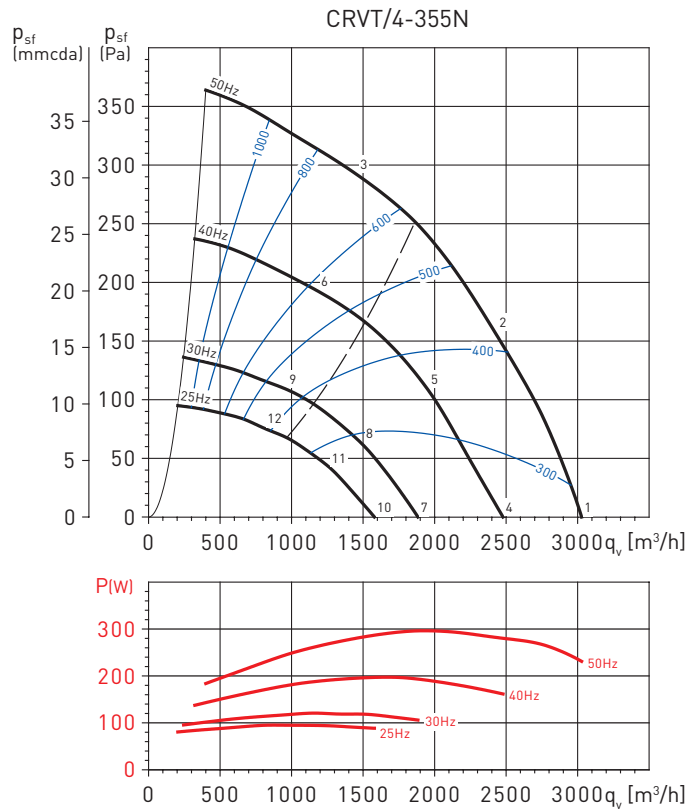
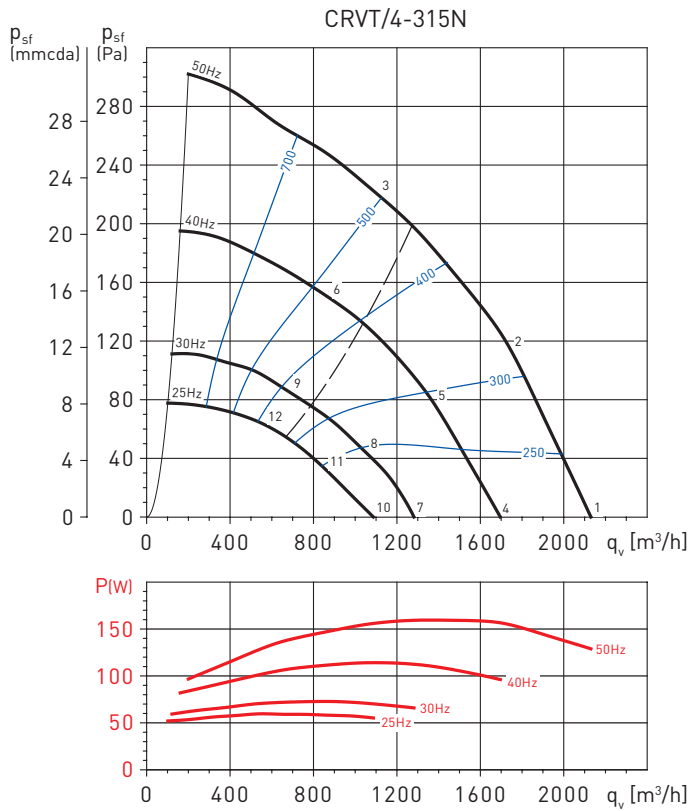

Punto de trabajo		63	125	250	500	1.000	2.000	4.000	8.000	LwA
1	Aspiración	39	52	59	61	61	62	60	47	68
	Descarga	38	56	63	66	67	66	64	50	73
2	Aspiración	33	47	55	57	57	59	53	43	64
	Descarga	34	53	58	62	64	63	56	46	69
3	Aspiración	31	43	53	55	57	54	48	40	61
	Descarga	33	53	56	60	65	60	53	43	68
4	Aspiración	35	48	55	57	57	58	56	43	63
	Descarga	34	52	59	62	63	62	60	46	68
5	Aspiración	28	42	50	52	52	54	48	38	59
	Descarga	29	48	53	57	59	58	51	41	64
6	Aspiración	27	39	49	51	53	50	44	36	57
	Descarga	29	49	52	56	61	56	49	39	63
7	Aspiración	29	42	49	51	51	52	50	37	57
	Descarga	28	46	53	56	57	56	54	40	62
8	Aspiración	23	37	45	47	47	49	43	33	53
	Descarga	24	43	48	52	54	53	46	36	58
9	Aspiración	21	33	43	45	47	44	38	30	51
	Descarga	23	43	46	50	55	50	43	33	58
10	Aspiración	25	38	45	47	47	48	46	33	54
	Descarga	24	42	49	52	53	52	50	36	58
11	Aspiración	19	33	41	43	43	45	39	29	50
	Descarga	20	39	44	48	50	49	42	32	54
12	Aspiración	17	29	39	41	43	40	34	26	47
	Descarga	19	39	42	46	51	46	39	29	54

Punto de trabajo		63	125	250	500	1.000	2.000	4.000	8.000	LwA
1	Aspiración	45	58	65	66	65	64	63	52	72
	Descarga	44	63	67	70	73	70	67	56	77
2	Aspiración	40	54	59	60	60	61	58	48	67
	Descarga	39	61	61	65	69	66	62	52	73
3	Aspiración	37	50	57	58	62	59	55	46	66
	Descarga	38	58	59	65	71	66	60	52	74
4	Aspiración	40	53	60	61	60	59	58	47	67
	Descarga	39	58	62	65	68	65	62	51	72
5	Aspiración	36	50	55	56	56	57	54	44	63
	Descarga	35	57	57	61	65	62	58	48	69
6	Aspiración	33	46	53	54	58	55	51	42	62
	Descarga	34	54	55	61	67	62	56	48	69
7	Aspiración	34	47	54	55	54	53	52	41	61
	Descarga	33	52	56	59	62	59	56	45	66
8	Aspiración	29	43	48	49	49	50	47	37	56
	Descarga	28	50	50	54	58	55	51	41	62
9	Aspiración	26	39	46	47	51	48	44	35	55
	Descarga	27	47	48	54	60	55	49	41	63
10	Aspiración	30	43	50	51	50	49	48	37	57
	Descarga	29	48	52	55	58	55	52	41	63
11	Aspiración	26	40	45	46	46	47	44	34	53
	Descarga	25	47	47	51	55	52	48	38	58
12	Aspiración	22	35	42	43	47	44	40	31	51
	Descarga	23	43	44	50	56	51	45	37	59

CURVAS CARACTERÍSTICAS - CARACTERÍSTICAS ACÚSTICAS CRVT 4 Polos

- q_v = Caudal en m^3/h .
- p_{sf} = Presión estática en mmcda y Pa.
- Potencia absorbida en W.
- SFP curvas azules en $W/m^3/s$.
- Aire seco normal a $20^\circ C$ y 760 mmHg.
- Ensayos realizados de acuerdo a Norma ISO 5801 y AMCA 210-99.

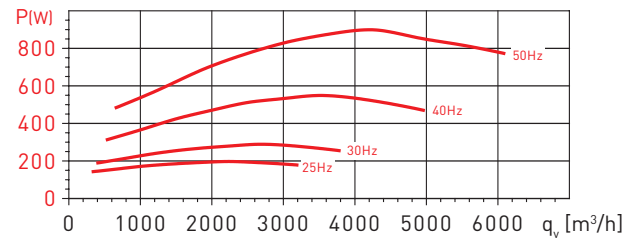
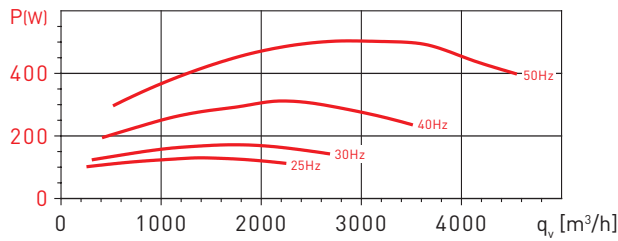
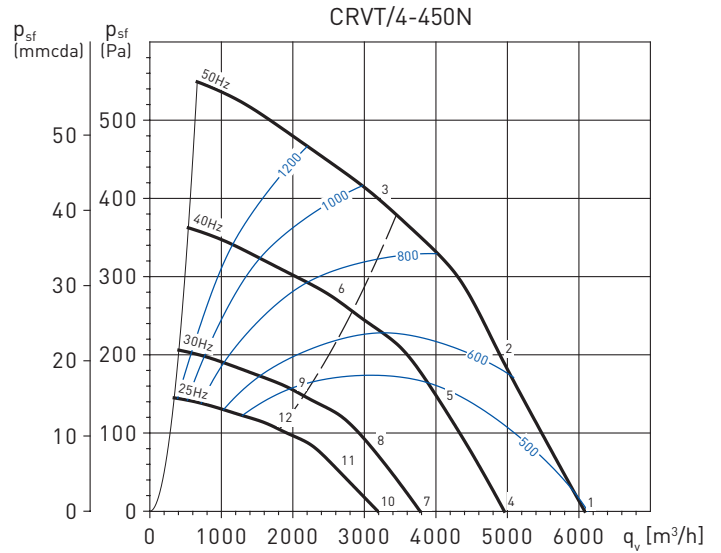
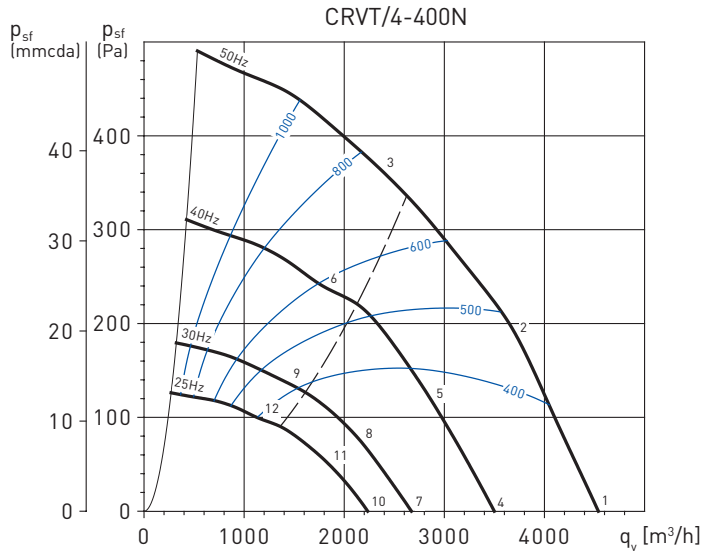

Punto de trabajo	63	125	250	500	1.000	2.000	4.000	8.000	LwA	
1	Aspiración	39	60	66	68	67	68	67	57	74
	Descarga	45	66	69	73	74	73	70	61	79
2	Aspiración	36	55	61	62	65	67	63	56	71
	Descarga	39	64	65	68	71	70	66	58	76
3	Aspiración	38	51	60	61	64	64	61	54	70
	Descarga	39	60	63	67	72	69	65	58	76
4	Aspiración	35	56	62	64	63	64	63	53	70
	Descarga	41	62	65	69	70	69	66	57	75
5	Aspiración	32	51	57	58	61	63	59	52	67
	Descarga	35	60	61	64	67	66	62	54	72
6	Aspiración	34	47	56	57	60	60	57	50	65
	Descarga	35	56	59	63	68	65	61	54	71
7	Aspiración	29	50	56	58	57	58	57	47	64
	Descarga	35	56	59	63	64	63	60	51	69
8	Aspiración	26	45	51	52	55	57	53	46	61
	Descarga	29	54	55	58	61	60	56	48	66
9	Aspiración	28	41	50	51	54	54	51	44	59
	Descarga	29	50	53	57	62	59	55	48	65
10	Aspiración	25	46	52	54	53	54	53	43	60
	Descarga	31	52	55	59	60	59	56	47	65
11	Aspiración	22	41	47	48	51	53	49	42	57
	Descarga	25	50	51	54	57	56	52	44	62
12	Aspiración	24	37	46	47	50	50	47	40	56
	Descarga	25	46	49	53	58	55	51	44	62

Punto de trabajo	63	125	250	500	1.000	2.000	4.000	8.000	LwA	
1	Aspiración	43	62	68	71	70	73	71	63	78
	Descarga	52	69	71	75	79	78	75	67	84
2	Aspiración	39	61	66	67	67	71	66	59	75
	Descarga	44	67	69	72	76	75	70	64	81
3	Aspiración	40	57	64	65	68	69	64	58	74
	Descarga	45	63	66	69	76	75	70	64	80
4	Aspiración	39	58	64	67	66	69	67	59	74
	Descarga	48	65	67	71	75	74	71	63	79
5	Aspiración	35	57	62	63	63	67	62	55	71
	Descarga	40	63	65	68	72	71	66	60	76
6	Aspiración	36	53	60	61	64	65	60	54	69
	Descarga	41	59	62	65	72	71	66	60	76
7	Aspiración	33	52	58	61	60	63	61	53	68
	Descarga	42	59	61	65	69	68	65	57	73
8	Aspiración	29	51	56	57	57	61	56	49	65
	Descarga	34	57	59	62	66	65	60	54	70
9	Aspiración	30	47	54	55	58	59	54	48	64
	Descarga	35	53	56	59	66	65	60	54	70
10	Aspiración	29	48	54	57	56	59	57	49	64
	Descarga	38	55	57	61	65	64	61	53	70
11	Aspiración	25	47	52	53	53	57	52	45	61
	Descarga	30	53	55	58	62	61	56	50	67
12	Aspiración	26	43	50	51	54	55	50	44	60
	Descarga	31	49	52	55	62	61	56	50	66

CURVAS CARACTERÍSTICAS - CARACTERÍSTICAS ACÚSTICAS CRVT 4 Polos

- q_v = Caudal en m^3/h .
- p_{sf} = Presión estática en mmcda y Pa.
- Potencia absorbida en W.
- SFP curvas azules en $W/m^3/s$.
- Aire seco normal a $20^\circ C$ y 760 mmHg.
- Ensayos realizados de acuerdo a Norma ISO 5801 y AMCA 210-99.

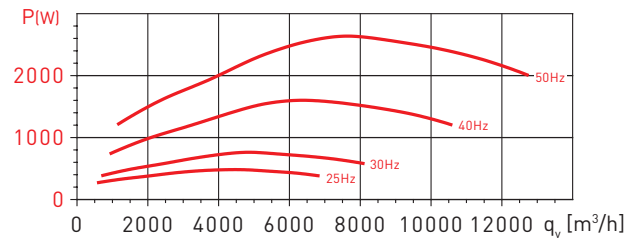
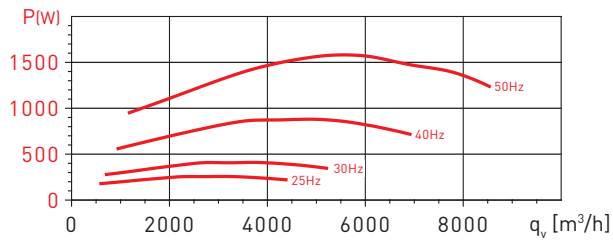
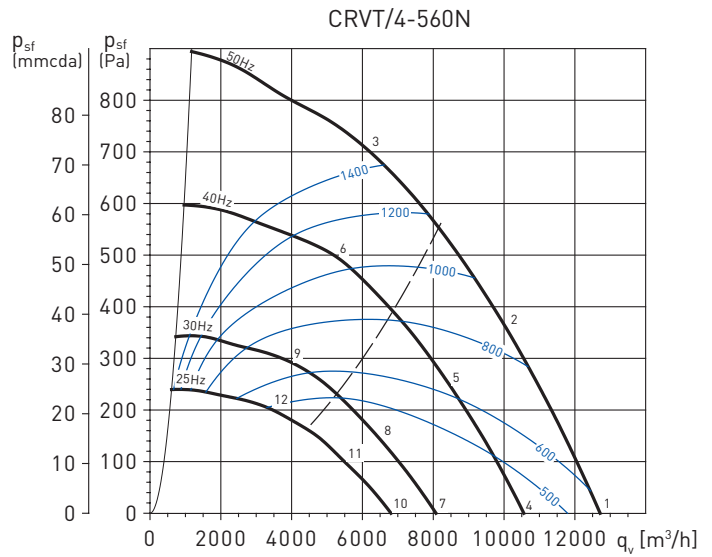
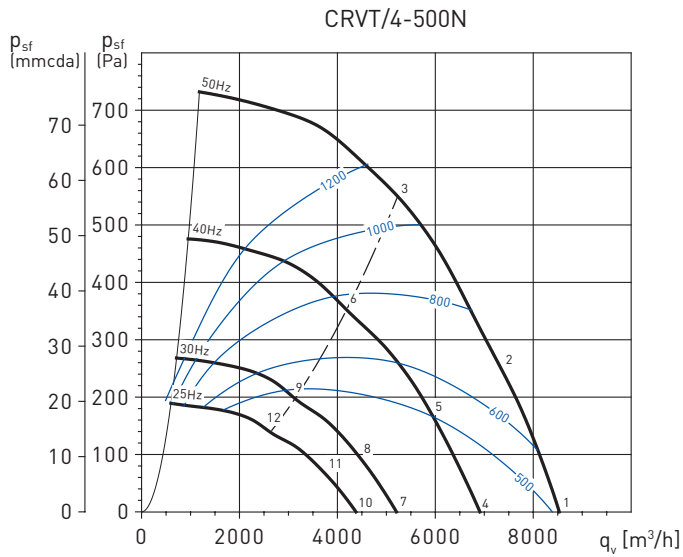

Punto de trabajo		63	125	250	500	1.000	2.000	4.000	8.000	LwA
1	Aspiración	51	70	77	77	78	77	76	72	84
	Descarga	57	72	78	82	84	82	79	75	89
2	Aspiración	50	67	73	73	75	75	73	68	81
	Descarga	53	69	74	78	81	80	76	70	86
3	Aspiración	42	64	69	68	73	75	72	67	80
	Descarga	45	63	69	74	78	80	76	70	84
4	Aspiración	46	65	72	72	73	72	71	67	80
	Descarga	52	67	73	77	79	77	74	70	84
5	Aspiración	45	62	68	68	70	70	68	63	77
	Descarga	48	64	69	73	76	75	71	65	81
6	Aspiración	37	59	64	63	68	70	67	62	75
	Descarga	40	58	64	69	73	75	71	65	79
7	Aspiración	40	59	66	66	67	66	65	61	74
	Descarga	46	61	67	71	73	71	68	64	78
8	Aspiración	39	56	62	62	64	64	62	57	70
	Descarga	42	58	63	67	70	69	65	59	75
9	Aspiración	31	53	58	57	62	64	61	56	69
	Descarga	34	52	58	63	67	69	65	59	73
10	Aspiración	36	55	62	62	63	62	61	57	70
	Descarga	42	57	63	67	69	67	64	60	74
11	Aspiración	35	52	58	58	60	60	58	53	67
	Descarga	38	54	59	63	66	65	61	55	71
12	Aspiración	27	49	54	53	58	60	57	52	65
	Descarga	30	48	54	59	63	65	61	55	69

Punto de trabajo		63	125	250	500	1.000	2.000	4.000	8.000	LwA
1	Aspiración	54	72	80	81	80	79	78	72	87
	Descarga	63	78	88	86	88	83	81	76	93
2	Aspiración	51	71	76	76	76	75	71	67	83
	Descarga	54	76	82	81	83	79	75	70	88
3	Aspiración	63	74	87	81	79	78	72	67	89
	Descarga	64	74	83	82	85	82	77	72	90
4	Aspiración	50	68	76	77	76	75	74	68	83
	Descarga	59	74	84	82	84	79	77	72	89
5	Aspiración	47	67	72	72	72	71	67	63	79
	Descarga	50	72	78	77	79	75	71	66	84
6	Aspiración	59	70	83	77	75	74	68	63	85
	Descarga	60	70	79	78	81	78	73	68	86
7	Aspiración	44	62	70	71	70	69	68	62	77
	Descarga	53	68	78	76	78	73	71	66	83
8	Aspiración	41	61	66	66	66	65	61	57	73
	Descarga	44	66	72	71	73	69	65	60	79
9	Aspiración	53	64	77	71	69	68	62	57	80
	Descarga	54	64	73	72	75	72	67	62	80
10	Aspiración	40	58	66	67	66	65	64	58	73
	Descarga	49	64	74	72	74	69	67	62	79
11	Aspiración	38	58	63	63	63	62	58	54	69
	Descarga	41	63	69	68	70	66	62	57	75
12	Aspiración	50	61	74	68	66	65	59	54	76
	Descarga	51	61	70	69	72	69	64	59	76

CURVAS CARACTERÍSTICAS - CARACTERÍSTICAS ACÚSTICAS CRVT 6 Polos

- q_v = Caudal en m^3/h .
- p_{sf} = Presión estática en mmcda y Pa.
- Potencia absorbida en W.
- SFP curvas azules en $W/m^3/s$.
- Aire seco normal a $20^\circ C$ y 760 mmHg.
- Ensayos realizados de acuerdo a Norma ISO 5801 y AMCA 210-99.

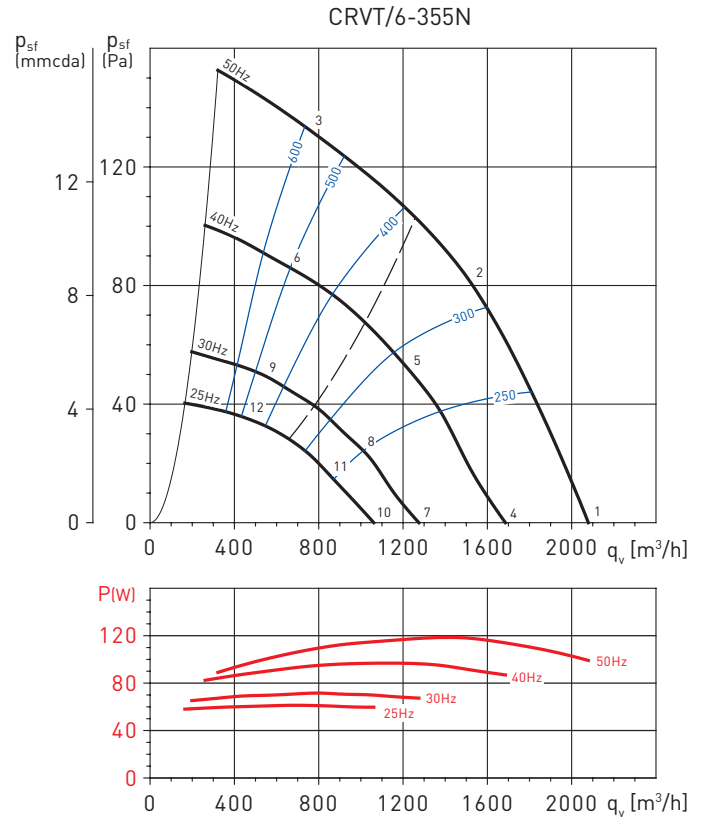
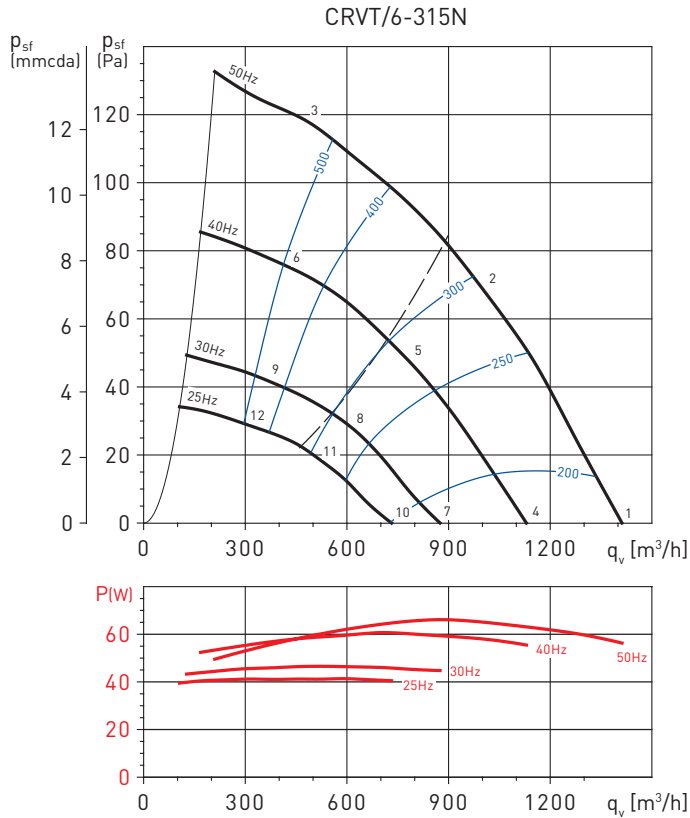

Punto de trabajo		63	125	250	500	1.000	2.000	4.000	8.000	LwA
1	Aspiración	36	46	47	49	52	55	40	33	58
	Descarga	37	47	51	54	57	58	43	35	62
2	Aspiración	37	46	45	46	48	43	36	33	53
	Descarga	39	47	49	52	54	47	39	34	58
3	Aspiración	37	45	47	47	48	42	36	32	54
	Descarga	38	47	49	53	56	48	39	33	59
4	Aspiración	31	41	42	44	47	50	35	28	53
	Descarga	32	42	46	49	52	53	38	30	57
5	Aspiración	32	41	40	41	43	38	31	28	48
	Descarga	34	42	44	47	49	42	34	29	53
6	Aspiración	33	41	43	43	44	38	32	28	49
	Descarga	34	43	45	49	52	44	35	29	55
7	Aspiración	25	35	36	38	41	44	29	22	47
	Descarga	26	36	40	43	46	47	32	24	51
8	Aspiración	27	36	35	36	38	33	26	23	43
	Descarga	29	37	39	42	44	37	29	24	47
9	Aspiración	27	35	37	37	38	32	26	22	43
	Descarga	28	37	39	43	46	38	29	23	49
10	Aspiración	21	31	32	34	37	40	25	18	44
	Descarga	22	32	36	39	42	43	28	20	47
11	Aspiración	23	32	31	32	34	29	22	19	39
	Descarga	25	33	35	38	40	33	25	20	44
12	Aspiración	23	31	33	33	34	28	22	18	39
	Descarga	24	33	35	39	42	34	25	19	45

Punto de trabajo		63	125	250	500	1.000	2.000	4.000	8.000	LwA
1	Aspiración	37	46	50	51	53	56	44	35	60
	Descarga	41	50	56	67	63	61	48	38	70
2	Aspiración	36	47	48	49	51	51	43	36	56
	Descarga	43	49	56	70	65	56	46	37	71
3	Aspiración	37	45	47	50	52	48	41	35	56
	Descarga	39	48	54	68	68	59	53	44	71
4	Aspiración	33	42	46	47	49	52	40	31	55
	Descarga	37	46	52	63	59	57	44	34	65
5	Aspiración	31	42	43	44	46	46	38	31	52
	Descarga	38	44	51	65	60	51	41	32	67
6	Aspiración	32	40	42	45	47	43	36	30	52
	Descarga	34	43	49	63	63	54	48	39	67
7	Aspiración	27	36	40	41	43	46	34	25	49
	Descarga	31	40	46	57	53	51	38	28	59
8	Aspiración	25	36	37	38	40	40	32	25	46
	Descarga	32	38	45	59	54	45	35	26	61
9	Aspiración	26	34	36	39	41	37	30	24	46
	Descarga	28	37	43	57	57	48	42	33	61
10	Aspiración	23	32	36	37	39	42	30	21	46
	Descarga	27	36	42	53	49	47	34	24	56
11	Aspiración	22	33	34	35	37	37	29	22	42
	Descarga	29	35	42	56	51	42	32	23	57
12	Aspiración	23	31	33	36	38	34	27	21	42
	Descarga	25	34	40	54	54	45	39	30	57

CURVAS CARACTERÍSTICAS - CARACTERÍSTICAS ACÚSTICAS CRVT 6 Polos

- q_v = Caudal en m^3/h .
- p_{sf} = Presión estática en mmcda y Pa.
- Potencia absorbida en W.
- SFP curvas azules en $W/m^3/s$.
- Aire seco normal a $20^\circ C$ y 760 mmHg.
- Ensayos realizados de acuerdo a Norma ISO 5801 y AMCA 210-99.

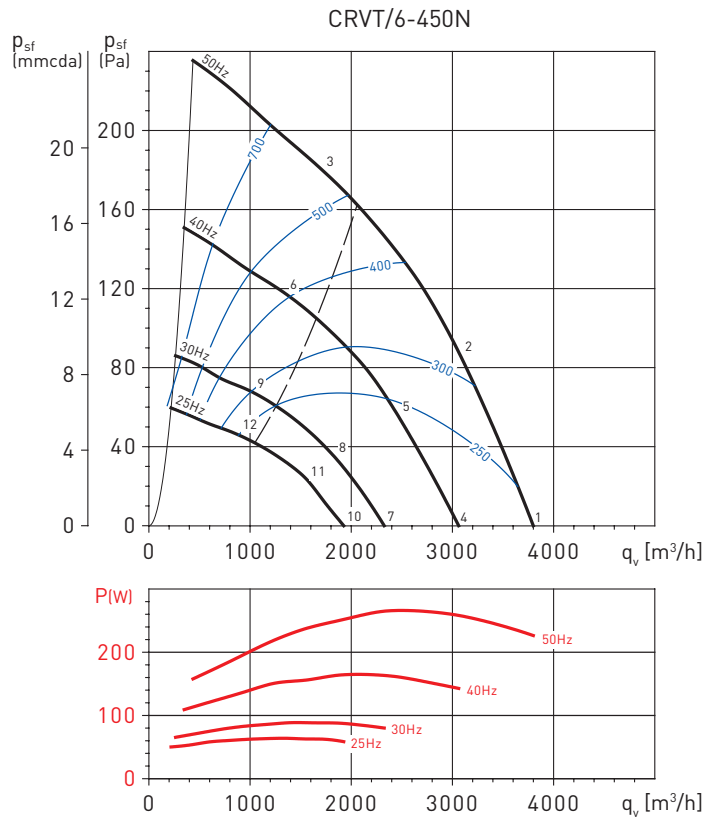
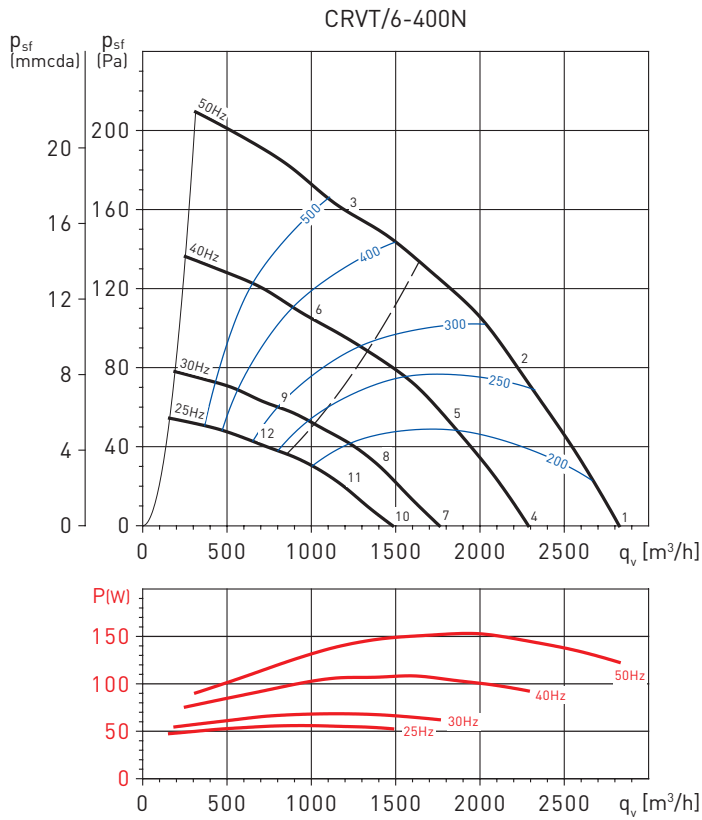

Punto de trabajo		63	125	250	500	1.000	2.000	4.000	8.000	LwA
1	Aspiración	36	46	56	57	62	61	51	43	66
	Descarga	38	52	59	63	67	65	54	47	71
2	Aspiración	32	43	52	54	59	54	46	37	62
	Descarga	35	48	55	60	63	58	49	40	66
3	Aspiración	36	44	51	51	53	49	44	35	58
	Descarga	38	49	55	57	60	56	49	40	64
4	Aspiración	31	41	51	52	57	56	46	38	61
	Descarga	33	47	54	58	62	60	49	42	66
5	Aspiración	28	39	48	50	55	50	42	33	57
	Descarga	31	44	51	56	59	54	45	36	62
6	Aspiración	32	40	47	47	49	45	40	31	53
	Descarga	34	45	51	53	56	52	45	36	59
7	Aspiración	26	36	46	47	52	51	41	33	55
	Descarga	28	42	49	53	57	55	44	37	60
8	Aspiración	22	33	42	44	49	44	36	27	52
	Descarga	25	38	45	50	53	48	39	30	56
9	Aspiración	26	34	41	41	43	39	34	25	47
	Descarga	28	39	45	47	50	46	39	30	54
10	Aspiración	22	32	42	43	48	47	37	29	52
	Descarga	24	38	45	49	53	51	40	33	56
11	Aspiración	18	29	38	40	45	40	32	23	48
	Descarga	21	34	41	46	49	44	35	26	52
12	Aspiración	22	30	37	37	39	35	30	21	44
	Descarga	24	35	41	43	46	42	35	26	50

Punto de trabajo		63	125	250	500	1.000	2.000	4.000	8.000	LwA
1	Aspiración	35	48	56	59	64	64	56	47	68
	Descarga	39	54	60	64	70	67	60	52	73
2	Aspiración	31	47	54	57	63	59	52	42	66
	Descarga	34	51	57	61	66	62	56	47	69
3	Aspiración	36	47	54	57	58	57	51	43	63
	Descarga	42	50	57	60	67	63	57	49	70
4	Aspiración	30	43	51	54	59	59	51	42	64
	Descarga	34	49	55	59	65	62	55	47	68
5	Aspiración	26	42	49	52	58	54	47	37	61
	Descarga	29	46	52	56	61	57	51	42	64
6	Aspiración	31	42	49	52	53	52	46	38	58
	Descarga	37	45	52	55	62	58	52	44	65
7	Aspiración	24	37	45	48	53	53	45	36	58
	Descarga	28	43	49	53	59	56	49	41	62
8	Aspiración	20	36	43	46	52	48	41	31	55
	Descarga	23	40	46	50	55	51	45	36	58
9	Aspiración	25	36	43	46	47	46	40	32	52
	Descarga	31	39	46	49	56	52	46	38	59
10	Aspiración	20	33	41	44	49	49	41	32	54
	Descarga	24	39	45	49	55	52	45	37	58
11	Aspiración	16	32	39	42	48	44	37	27	51
	Descarga	19	36	42	46	51	47	41	32	54
12	Aspiración	21	32	39	42	43	42	36	28	49
	Descarga	27	35	42	45	52	48	42	34	55

CURVAS CARACTERÍSTICAS - CARACTERÍSTICAS ACÚSTICAS CRVT 6 Polos

- q_v = Caudal en m^3/h .
- p_{sf} = Presión estática en mmcda y Pa.
- Potencia absorbida en W.
- SFP curvas azules en $W/m^3/s$.
- Aire seco normal a $20^\circ C$ y 760 mmHg.
- Ensayos realizados de acuerdo a Norma ISO 5801 y AMCA 210-99.

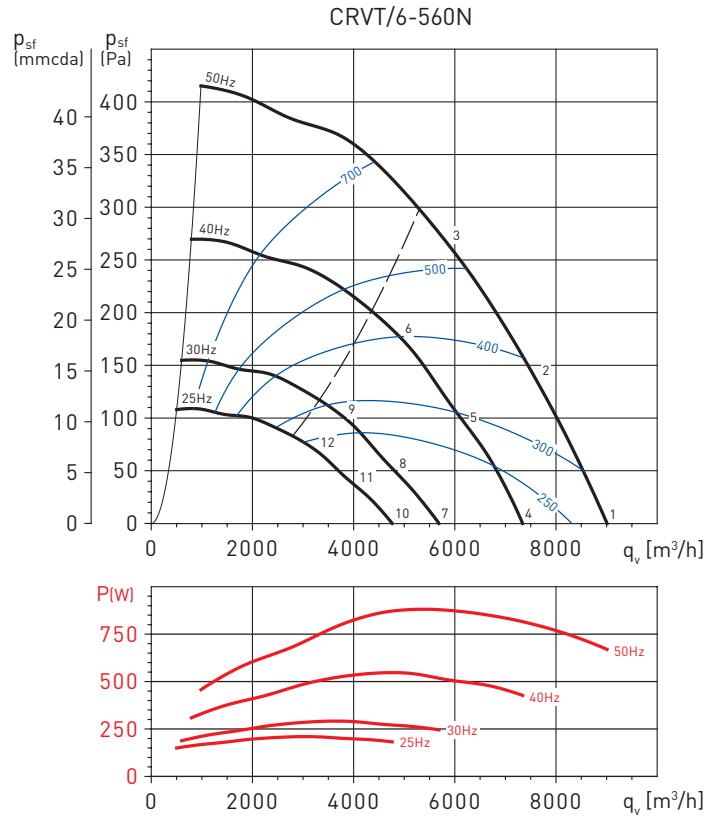
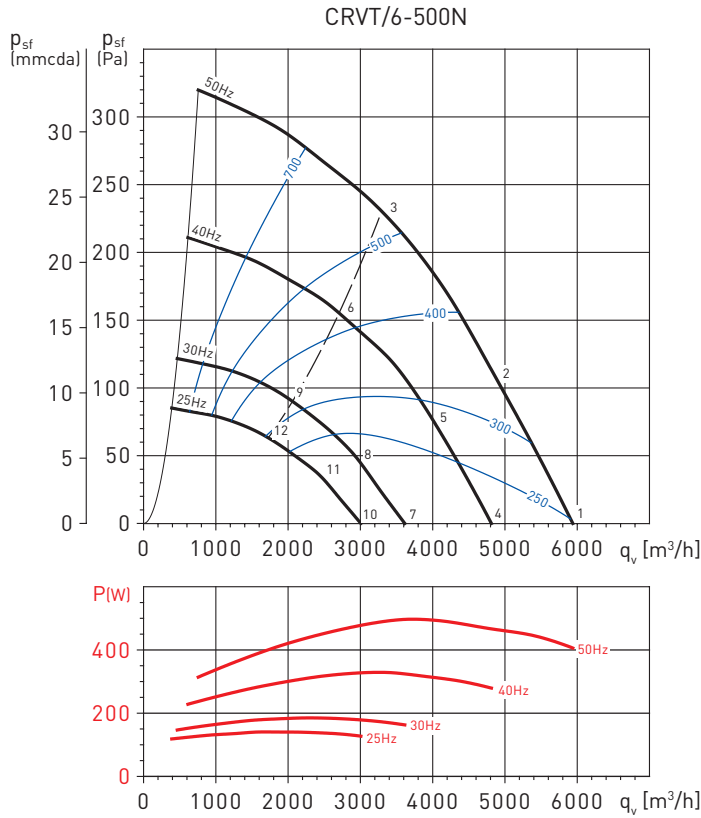

Punto de trabajo		63	125	250	500	1.000	2.000	4.000	8.000	LwA
1	Aspiración	40	53	61	61	63	66	62	55	70
	Descarga	43	61	64	68	70	69	65	57	75
2	Aspiración	35	48	57	57	61	62	60	52	67
	Descarga	38	59	61	65	67	66	62	54	72
3	Aspiración	36	46	56	59	62	62	58	52	67
	Descarga	35	54	58	65	68	67	61	54	72
4	Aspiración	36	49	57	57	59	62	58	51	66
	Descarga	39	57	60	64	66	65	61	53	71
5	Aspiración	31	44	53	53	57	58	56	48	63
	Descarga	34	55	57	61	63	62	58	50	68
6	Aspiración	32	42	52	55	58	58	54	48	63
	Descarga	31	50	54	61	64	63	57	50	68
7	Aspiración	30	43	51	51	53	56	52	45	60
	Descarga	33	51	54	58	60	59	55	47	65
8	Aspiración	25	38	47	47	51	52	50	42	57
	Descarga	28	49	51	55	57	56	52	44	62
9	Aspiración	26	36	46	49	52	52	48	42	57
	Descarga	25	44	48	55	58	57	51	44	62
10	Aspiración	26	39	47	47	49	52	48	41	56
	Descarga	29	47	50	54	56	55	51	43	61
11	Aspiración	21	34	43	43	47	48	46	38	53
	Descarga	24	45	47	51	53	52	48	40	58
12	Aspiración	22	32	42	45	48	48	44	38	53
	Descarga	21	40	44	51	54	53	47	40	58

Punto de trabajo		63	125	250	500	1.000	2.000	4.000	8.000	LwA
1	Aspiración	47	64	72	70	69	71	66	63	77
	Descarga	53	70	74	74	76	73	69	65	81
2	Aspiración	45	64	69	67	66	67	62	55	74
	Descarga	47	65	70	72	73	69	65	59	78
3	Aspiración	39	60	65	64	65	65	61	56	72
	Descarga	42	60	66	69	71	68	65	59	76
4	Aspiración	43	60	68	66	65	67	62	59	73
	Descarga	49	66	70	70	72	69	65	61	77
5	Aspiración	41	60	65	63	62	63	58	51	70
	Descarga	43	61	66	68	69	65	61	55	73
6	Aspiración	35	56	61	60	61	61	57	52	67
	Descarga	38	56	62	65	67	64	61	55	71
7	Aspiración	37	54	62	60	59	61	56	53	67
	Descarga	43	60	64	64	66	63	59	55	71
8	Aspiración	35	54	59	57	56	57	52	45	64
	Descarga	37	55	60	62	63	59	55	49	68
9	Aspiración	29	50	55	54	55	55	51	46	61
	Descarga	32	50	56	59	61	58	55	49	65
10	Aspiración	33	50	58	56	55	57	52	49	63
	Descarga	39	56	60	60	62	59	55	51	67
11	Aspiración	31	50	55	53	52	53	48	41	60
	Descarga	33	51	56	58	59	55	51	45	64
12	Aspiración	25	46	51	50	51	51	47	42	58
	Descarga	28	46	52	55	57	54	51	45	62

CURVAS CARACTERÍSTICAS - CARACTERÍSTICAS ACÚSTICAS CRVT 6 Polos

- q_v = Caudal en m^3/h .
- p_{sf} = Presión estática en mmca y Pa.
- Potencia absorbida en W.
- SFP curvas azules en $W/m^3/s$.
- Aire seco normal a $20^\circ C$ y 760 mmHg.
- Ensayos realizados de acuerdo a Norma ISO 5801 y AMCA 210-99.

CRVT/6-630N

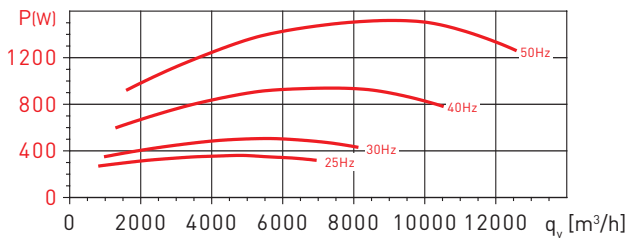
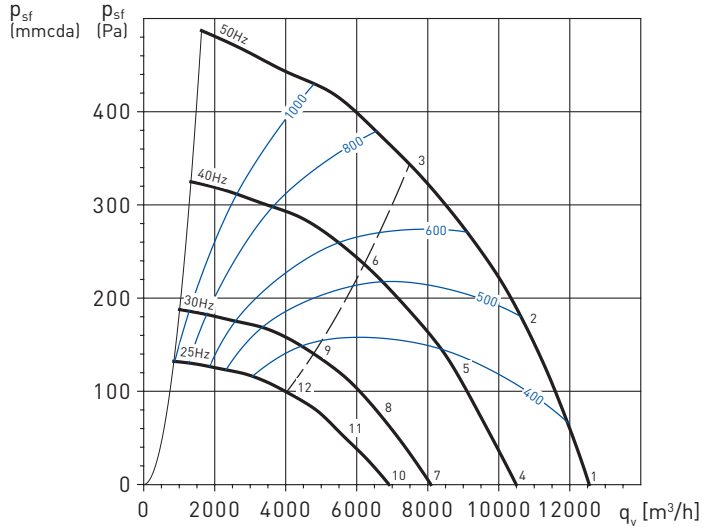

Punto de trabajo		63	125	250	500	1.000	2.000	4.000	8.000	LwA
1	Aspiración	52	66	72	71	73	74	68	64	79
	Descarga	58	71	76	78	78	78	72	67	84
2	Aspiración	47	63	69	68	70	69	65	60	76
	Descarga	51	69	74	75	75	73	69	63	81
3	Aspiración	47	60	66	66	69	69	65	59	75
	Descarga	50	66	72	73	75	74	69	64	80
4	Aspiración	48	62	68	67	69	70	64	60	75
	Descarga	54	67	72	74	74	74	68	63	80
5	Aspiración	43	59	65	64	66	65	61	56	72
	Descarga	47	65	70	71	71	69	65	59	77
6	Aspiración	43	56	62	62	65	65	61	55	71
	Descarga	46	62	68	69	71	70	65	60	76
7	Aspiración	42	56	62	61	63	64	58	54	69
	Descarga	48	61	66	68	68	68	62	57	74
8	Aspiración	37	53	59	58	60	59	55	50	66
	Descarga	41	59	64	65	65	63	59	53	71
9	Aspiración	37	50	56	56	59	59	55	49	65
	Descarga	40	56	62	63	65	64	59	54	70
10	Aspiración	38	52	58	57	59	60	54	50	66
	Descarga	44	57	62	64	64	64	58	53	70
11	Aspiración	33	49	55	54	56	55	51	46	62
	Descarga	37	55	60	61	61	59	55	49	67
12	Aspiración	34	47	53	53	56	56	52	46	61
	Descarga	37	53	59	60	62	61	56	51	67

INSTALACIÓN - ACCESORIOS DE MONTAJE

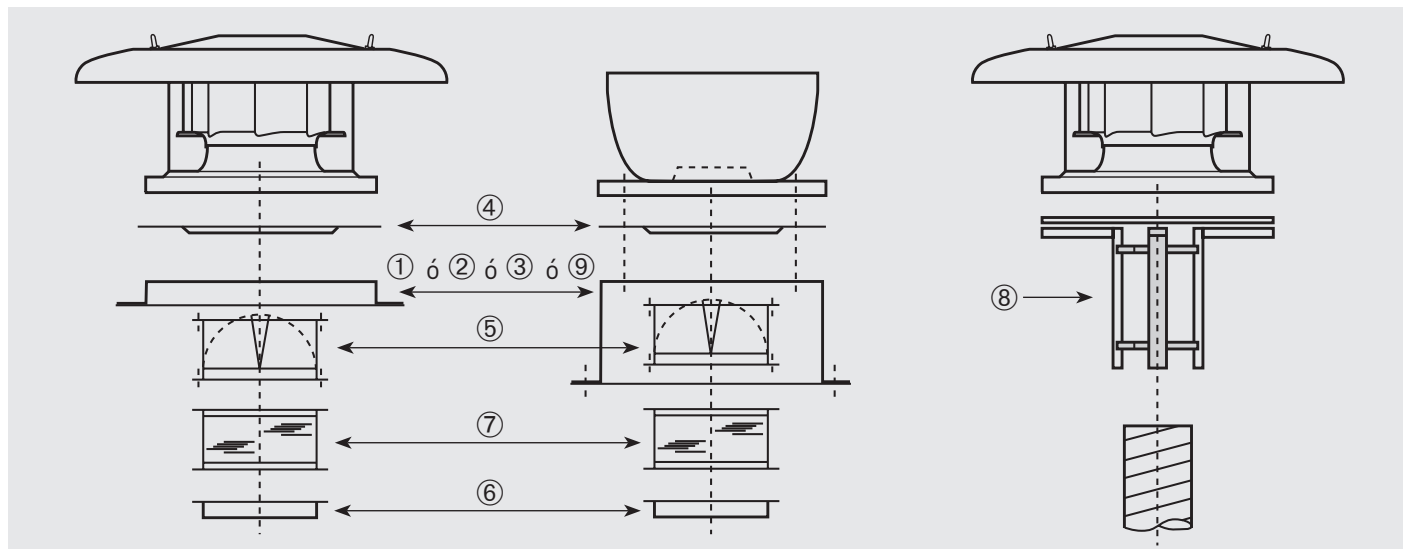

Modelo de extractor	① Marco soporte	② Base soporte aislada	③ Base atenuadora acústica	④ Placa de adaptación	⑤ Compuerta antirretorno	⑥ Brida	⑦ Acoplamiento elástico	⑧ Adaptación circular	⑨ Base soporte cubiertas inclinadas
225N	JMS-300	JBS-300	JAA-300	JPA-300	JCA-300	JBR-300 N	JAE-300 N	JCC-300	BI-3
250N	JMS-300	JBS-300	JAA-300	JPA-300	JCA-300	JBR-300 N	JAE-300 N	JCC-300	BI-3
280N	JMS-435	JBS-435	JAA-435	JPA-435	JCA-435	JBR-435 N	JAE-435 N	JCC-435	BI-4
315N	JMS-560	JBS-560	JAA-560	JPA-560	JCA-560 N	JBR-560 N	JAE-560 N	JCC-560	BI-5
355N	JMS-560	JBS-560	JAA-560	JPA-560	JCA-560 N	JBR-560 N	JAE-560 N	JCC-560	BI-5
400N	JMS-630	JBS-630	JAA-630	JPA-630	JCA-630 N	JBR-630 N	JAE-630 N	JCC-630	BI-6
450N	JMS-630	JBS-630	JAA-630	JPA-630	JCA-630 N	JBR-630 N	JAE-63 N 0	JCC-630	BI-6
500N	JMS-710	JBS-710	JAA-710	JPA-710	JCA-710 N	JBR-710 N	JAE-710 N	-	BI-7
560N	JMS-905	JBS-905	JAA-905	JPA-905	JCA-905	JBR-905 N	JAE-905 N	-	BI-9
630N	JMS-905	JBS-905	JAA-905	JPA-905	JCA-905	JBR-905 N	JAE-905 N	-	BI-9

ACCESORIOS DE MONTAJE

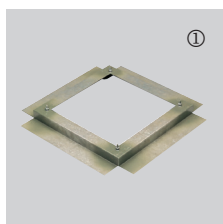

Marco soporte JMS

- Para el montaje de los tejados en los zócalos.
- Se suministra la tornillería y una junta de goma para la estanqueidad.

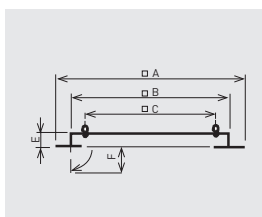

Modelo	□A	□B	□C	E	F
JMS-300	470	290	245	50	70
JMS-435	600	420	330	50	70
JMS-560	725	545	450	50	70
JMS-630	795	615	535	50	70
JMS-710	875	695	590	50	70
JMS-905	1065	885	750	60	70

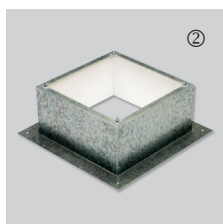

Base soporte JBS

- Para el montaje de los ventiladores en tejados lisos sin zócalo.
- Montar en tejados horizontales.
- Aislamiento interno para evitar la condensación.
- Se suministra la tornillería y una junta de goma para la estanqueidad.

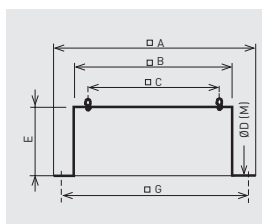

Modelo	□A	□B	□C	Ø D (M)	E	□G
JBS-300	470	289	245	10,5 (M8)	300	380
JBS-435	600	419	330	11 (M10)	300	510
JBS-560	725	544	450	11 (M10)	300	635
JBS-630	795	614	535	11 (M10)	300	705
JBS-710	875	694	590	16 (M14)	300	785
JBS-905	1065	884	750	16 (M14)	400	975

ACCESORIOS DE MONTAJE



Placa de adaptación JPA

- Utilizado para el montaje de los accesorios (JCA, JBR, JAE).
- Permite desmontar el extractor de su soporte sin que sea necesario desmontar el conducto conectado al extractor.

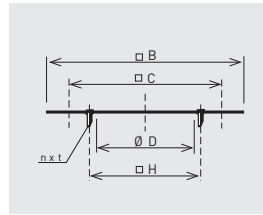

Modelo	□B	□C	∅D	nxt	∅H
JPA-300	289	245	182	4xM6	205
JPA-435	419	330	252	4xM8	280
JPA-560	544	450	358	8xM8	395
JPA-630	614	535	403	8xM10	450
JPA-710	694	590	503	12xM10	560
JPA-905	884	750	633	12xM10	690



Compuerta antirretorno JCA / JCA N

- Evita la circulación de aire y las fugas de calefacción cuando el extractor está parado.
- Se monta a la aspiración del extractor con la placa JPA.

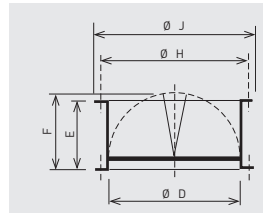

Modelo	∅D	E	F	∅H	∅J
JCA-300	182	100	124	205	219
JCA-435	252	145	174	280	300
JCA-560 N	358	210	227	395	415
JCA-630 N	403	240	250	450	474
JCA-710 N	503	285	300	560	581
JCA-905 N	633	345	365	690	714



Brida JBR N

- A utilizar cuando se requiere conectar un conducto circular directamente al extractor.
- Se monta a la aspiración del extractor con la placa JPA o se fija directamente a la base del extractor (remaches o tornillos).

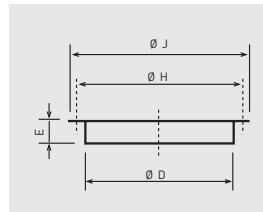

Modelo	∅D	E	∅H	∅J
JBR-300 N	182	55	205	219
JBR-435 N	252	55	280	300
JBR-560 N	358	55	395	415
JBR-630 N	403	63	450	474
JBR-710 N	503	69	560	581
JBR-905 N	633	69	690	714

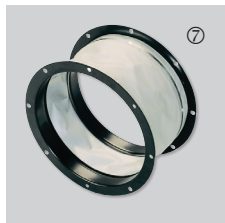

Acoplamiento elástico JAE N

- Limita la transmisión de vibraciones cuando el conducto está conectado directamente al extractor.
- Se monta a la aspiración del extractor con la placa JPA.

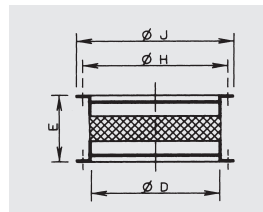

Modelo	∅D	E	∅H	∅J
JAE-300 N	182	164	205	219
JAE-435 N	252	164	280	300
JAE-560 N	358	164	395	415
JAE-630 N	403	164	450	474
JAE-710 N	503	164	560	581
JAE-905 N	633	164	690	714

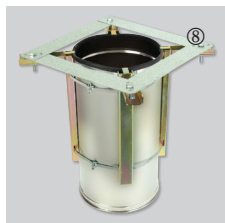

Adaptación conductos circulares JCC

- Para montar los ventiladores de tejado, hasta el modelo 400 directamente encima de un conducto circular.

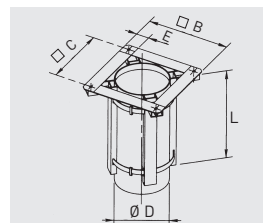

Modelo	∅B	∅C	∅D	E	L
JCC-300	290	245	180	45	350
JCC-435	390	330	250	60	350
JCC-560	520	450	355	70	350
JCC-630	605	535	400	70	350



Bases soporte BI para cubiertas inclinadas

- Para determinar el producto es imprescindible indicar el ángulo de inclinación de la cubierta y la distancia entre perfiles de sujeción de la misma (vigas).

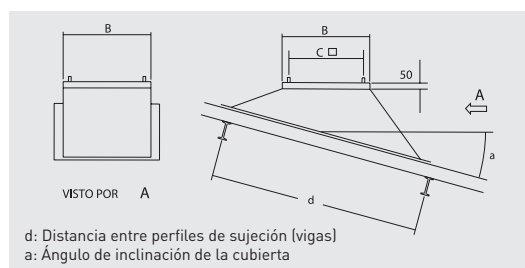

	B	C
BI-3	289	245
BI-4	419	330
BI-5	544	450
BI-6	614	535
BI-7	694	590
BI-9	884	750

d: Distancia entre perfiles de sujeción (vigas)
a: Ángulo de inclinación de la cubierta

ACCESORIOS DE MONTAJE



Base atenuadora acústica JAA
- Para montar en ventiladores de tejado y atenuar el nivel sonoro en el interior del local.
- Montar en tejados horizontales.
- Se suministra la tornillería y una junta de goma para la estanqueidad.

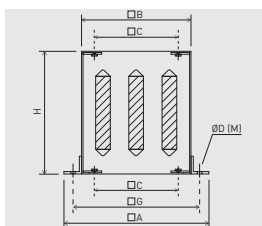

Modelo	ØA	ØB	ØC	Ø D (M)	H	ØG
JAA-300	470	290	245	13 (M10)	750	380
JAA-435	600	419	330	15 (M12)	750	510
JAA-560	725	545	450	15 (M12)	750	635
JAA-630	795	615	535	15 (M12)	750	705
JAA-710	875	695	590	18 (M14)	1000	785
JAA-905	1065	885	750	18 (M14)	1000	975

Base atenuadora acústica JAA

Atenuación acústica en dB(A), por banda de frecuencia (Hz).

Modelo	125	250	500	1000	2000	4000	8000
JAA-300	1	5	13	22	23	16	12
JAA-435	1	7	16	23	25	18	13
JAA-560	2	8	16	29	32	26	17
JAA-630	2	8	14	24	27	19	13
JAA-710	2	8	14	24	28	16	11
JAA-905	2	7	14	26	30	19	12

Base atenuadora acústica JAA

Pérdida de carga de los soportes acústicos JAA.

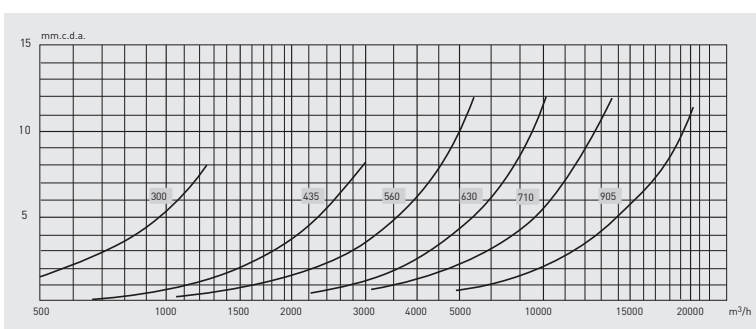

ACCESORIOS ELÉCTRICOS



REB
Reguladores de velocidad electrónicos monofásicos.



REB-5 / REB-10
Reguladores de velocidad electrónicos monofásicos.



RMB / RMT
Reguladores de velocidad electromecánicos monofásicos y trifásicos.



VAPZ
Reguladores electrónicos de tensión para ventiladores monofásicos 230V-50Hz. Entrada analógica 0-10V ó 0-20mA: El ventilador funciona proporcionalmente al valor de entrada con ajustes de los valores mínimos y máximos de las entradas y de las salidas.



VRPU
Reguladores electrónicos de tensión con display para ventiladores monofásicos 230V, 50/60Hz. El ventilador funciona proporcionalmente a un señal analógico de entrada (3-10V o 4-20mA) o, esta regulado para mantener una consigna externa (0-10V o 4-20 mA).



VFTM IP21
Convertidores de frecuencia para motores trifásicos de 0,37 a 15 kW. Caja Din Rail IP21.



VFTM IP54
Convertidores de frecuencia para motores de 0,37 a 15 kW.