



The UTBS are low profile air handling units designed specifically for installation in false ceiling. The range includes 4 different sizes for airflows between 500 and 8000 m<sup>3</sup>/h:

- UTBS-2: airflow from 500 to 1700 m<sup>3</sup>/h and 360 mm height.
- UTBS-3: airflow from 1200 to 3000 m<sup>3</sup>/h and 410 mm height.
- UTBS-5: airflow from 2400 to 5000 m<sup>3</sup>/h and 410mm height.
- UTBS-8: airflow from 4000 to 8000 m<sup>3</sup>/h and 500 mm height.

The framework is made of extruded aluminium profiles and reinforced nylon corner joints.

Double skin sandwich panels with 25 mm mineral wool insulation (good thermal and acoustic performance).

Plastic coated outer panel and galvanised steel inner panel.

High performance backward curved centrifugal, direct driven fans (plug fans) dynamically balanced.

High efficiency three phase motors with protection IP54 and insulation class F. Motors are designed to work with a frequency drive.

Motors equipped with thermal protection (PTO).

Components / Moduls:

- Chilled water coils with stainless steel drip tray and droplet eliminator.
- Heat exchanger.
- By-pass for free-cooling.
- Sound attenuators.
- Mixing box.
- Filter box.
- Plenum box.



**Easy access**  
 Easy access to filters and fans from the side.



**Robust construction**  
 High quality finishing with aluminium profile structure, providing a robust and tight assembly.



**Easy access to filters**  
 Easy-to-assemble filter mounting system.

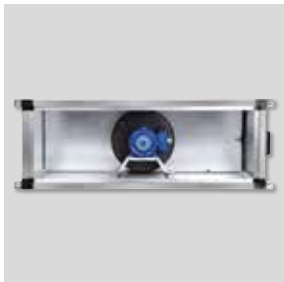

**Side junction box**  
 For ease of access during installation.



**Pressure tapings**  
 Pressure tapings in the filters and the fans.



**Cable glands**  
 Glands for the motor wiring cable.

**Specific applications**



Multi dwelling blocks



**Product selection software**  
 S&P air handling units selection software available.

## TECHNICAL CHARACTERISTICS

UTBS model	Fan model	Total pressure (Pa)	Maximum airflow (m³/h)	Three phase motor 400 V		Three phase electrical resistance		
				Power (kW)	Maximum current (A)	Power (kW)	Absorbed current (A)	Nº stages
UTBS-2	BPFM 250-2T	310	1700	0,25	0,68	15	37,5	2
		500	1700	0,37	0,95			
		725	1700	0,55	1,35			
UTBS-3	BPFM 280-2T	155	2300	0,25	0,68	24	60	2
		250	3000	0,55	1,35			
		490	3000	0,75	1,75			
		830	3000	1,1	2,55			
		1150	3000	1,5	3,84			
		1600	3000	2,2	4,98			
UTBS-5	BPFM 280-2T	260	4000	2 x 0,25	2 x 0,68	36	90	3
		480	5000	2 x 0,55	2 x 1,35			
		700	5000	2 x 0,75	2 x 1,75			
		1000	5000	2 x 1,1	2 x 2,55			
		1300	5000	2 x 1,5	2 x 3,84			
		1600	5000	2 x 2,2	2 x 4,98			
UTBS-8	BPFM 315-2T	160	5000	2 x 0,25	2 x 0,68	45	112,5	3
		225	7000	2 x 0,55	2 x 1,35			
		230	8000	2 x 0,75	2 x 1,75			
		525	8000	2 x 1,1	2 x 2,55			
		840	8000	2 x 1,5	2 x 3,84			
		1275	8000	2 x 2,2	2 x 4,98			

### Filtering section

The filtering section has two flat filters built with galvanised steel frame. This section includes a pre-filter and a high-efficiency low pressure drop filter.

Pre-filters: G4 filters with > 90% efficiency according to the gravimetric test, or F5 filters with > 40% efficiency according to the opacimetric test. Filters: High-efficiency F6, F7, F8 or F9 filters with an efficiency level above 60% for the F6 model and above 95% for the F9 model, according to the opacimetric test.

The filters comply with the UNE 779:2002 standard regarding filter performance.

Easy fixing system for filters with a high tightness guarantee.

### Coil section

#### Water coils

The water coils are made of copper pipes and aluminium fins, fitted in a galvanised steel casing.

In the section it can be included one or two water coils.

(one heating or one cooling coil or both at the same time).

The units can be supplied with 2,4 or 6-row for heating coils and 4 or 6-row for cooling coils. The section include one heating or cooling coil.

Cooling coil: always supplied as a standard with condensate drip tray made for stainless steel AISI 304 and a droplet eliminator.

The connections of the water coil and the drip tray can be ordered on left side or right side of the unit.

#### Electric heaters

The unit can be supplied with electric heaters made of shielded resistances with a galvanised sheet frame. The heaters are equipped with safety protection with manual and automatic reset. The heater has an anti-radiation screen to protect the filters.

### Ventilation

Sizes 2 and 3 have one fan, whereas sizes 5 and 8 have two.

For each size, there are several motor power settings to ensure highest efficiency at the required working point. The frequency drive is optional. The motors junction box is located Sidelly on the inspection side for ease the wiring.

TECHNICAL CHARACTERISTICS - UTBS 2

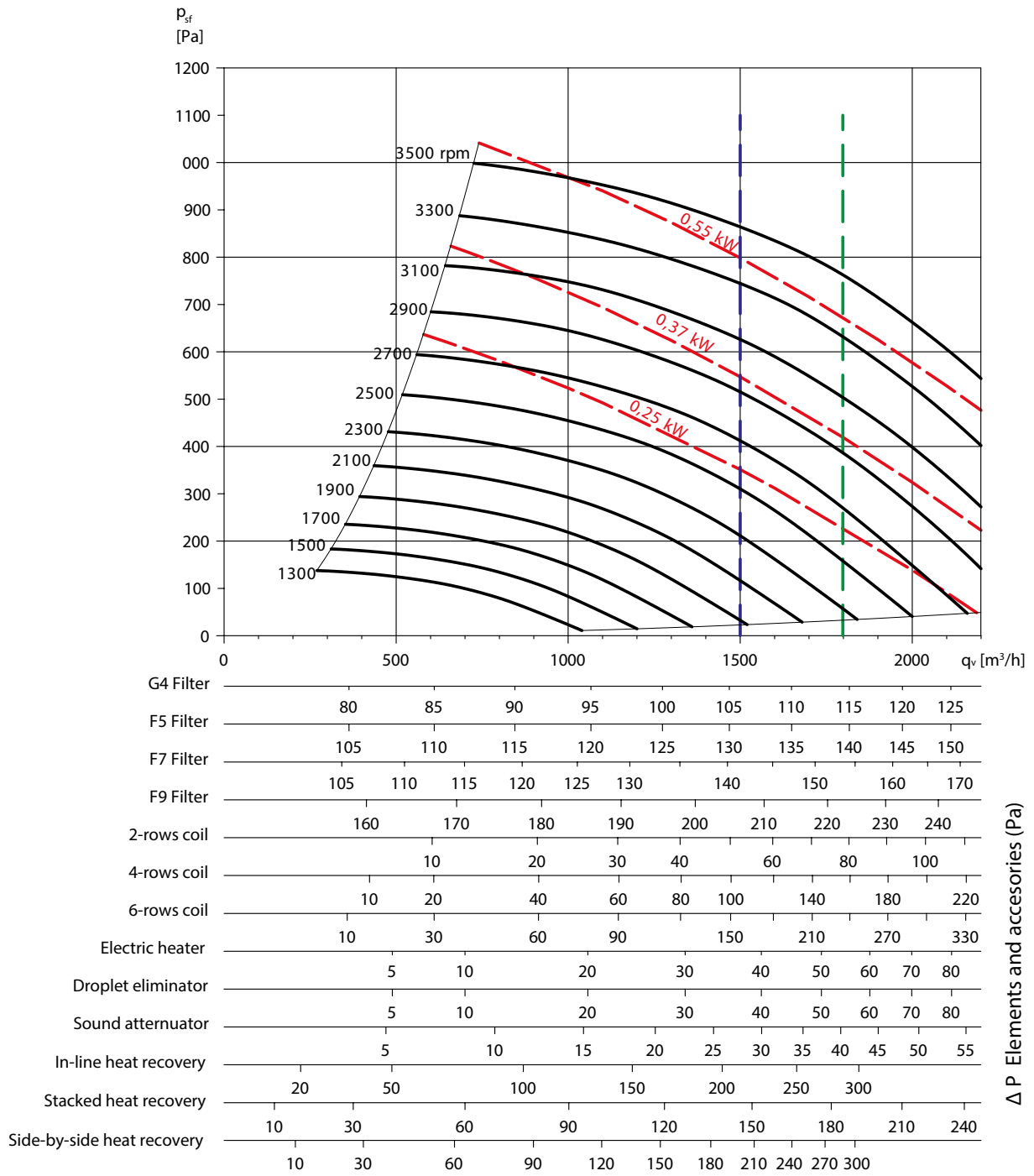

- — — Recommended working limit for cold coils = cooling coils
- — — Recommended working limit for heat coils = heating coils

TECHNICAL CHARACTERISTICS - UTBS 3

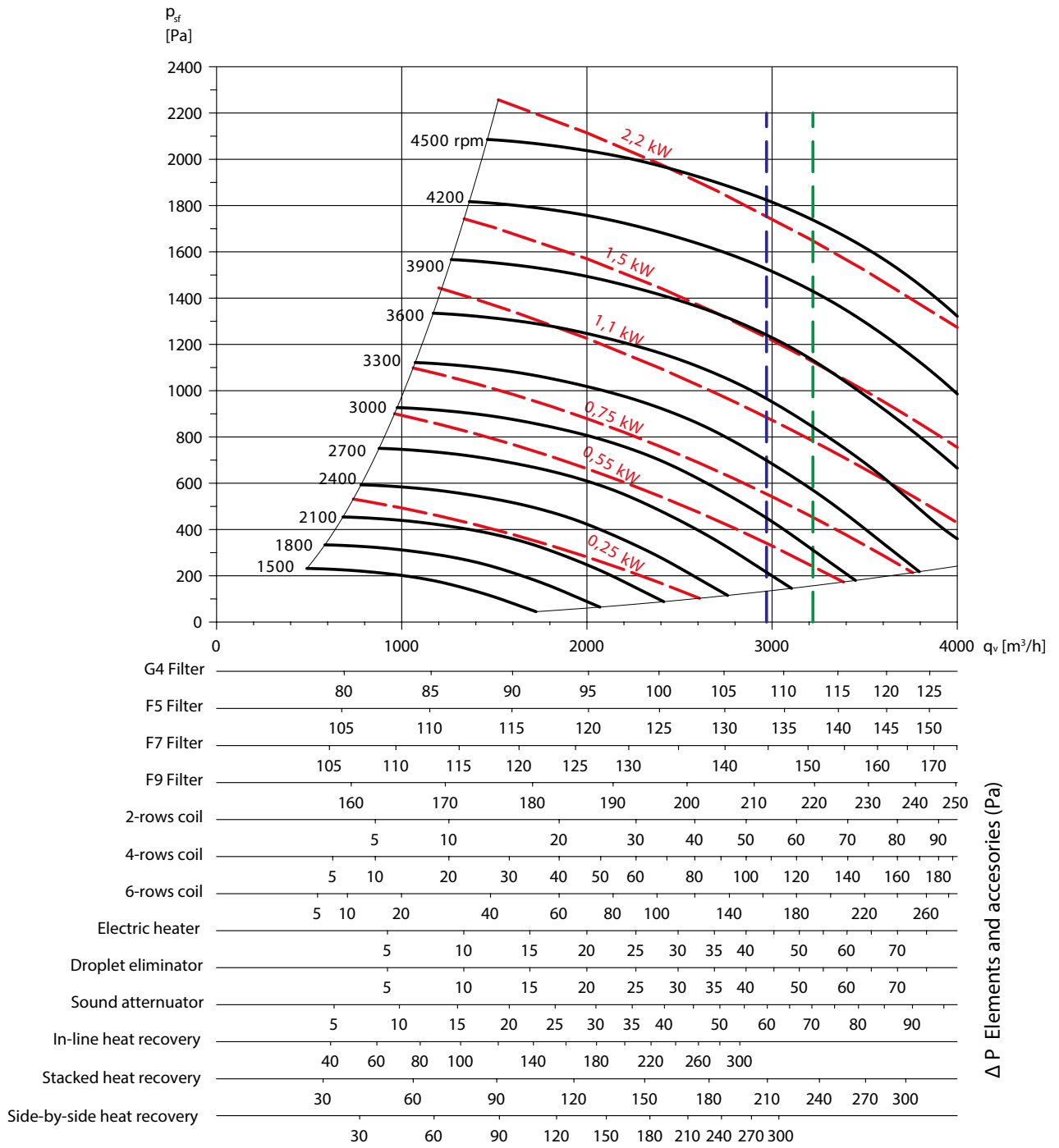

— — — — — Recommended working limit for cold coils = cooling coils

— — — — — Recommended working limit for heat coils = heating coils

TECHNICAL CHARACTERISTICS - UTBS 5

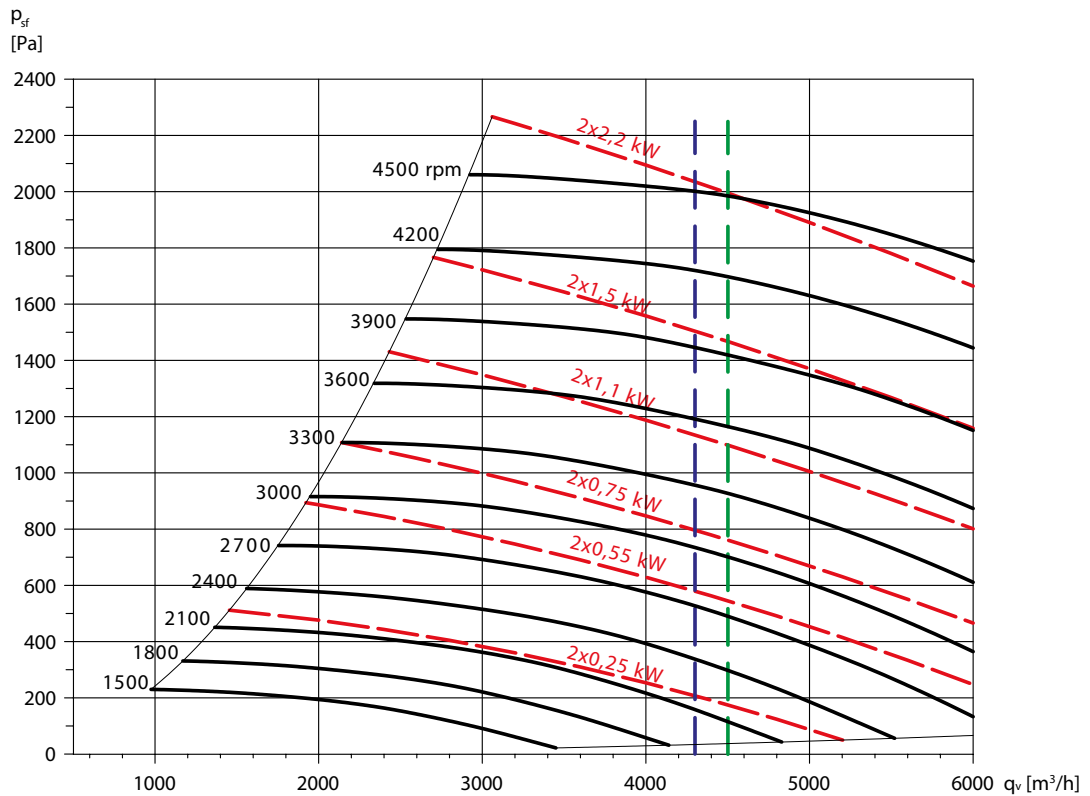

G4 Filter	80	85	90	95	100	105	110	115	120	125	130
F5 Filter	105	110	115	120	125	130	135	140	145	150	155
F7 Filter	105	110	115	120	125	130	135	140	150	160	170
F9 Filter	120	130	140	150	160	170	180	190	200	210	
2-rows coil		5	10	20	30	40	50	60	70	80	90
4-rows coil		5	10	20	30	40	50	60	70	80	90
6-rows coil		5	10	20	30	40	50	60	70	80	90
Electric heater		10	20	40	60	80	100	120	140	160	200
Droplet eliminator		5	10	20	30	40	50	60	70	80	90
Sound attenuator		5	10	20	30	40	50	60	70	80	90
In-line heat recovery		5	10	15	20	25	30	35	40	45	50
Stacked heat recovery		40	60	80	100	120	140	180	220	260	300
Side-by-side heat recovery		40	60	80	100	120	140	160	180	220	260
		30	60	90	120	150	180	240	300		

Δ P Elements and accessories (Pa)

— — — — — Recommended working limit for cold coils = cooling coils

— — — — — Recommended working limit for heat coils = heating coils

TECHNICAL CHARACTERISTICS - UTBS 8

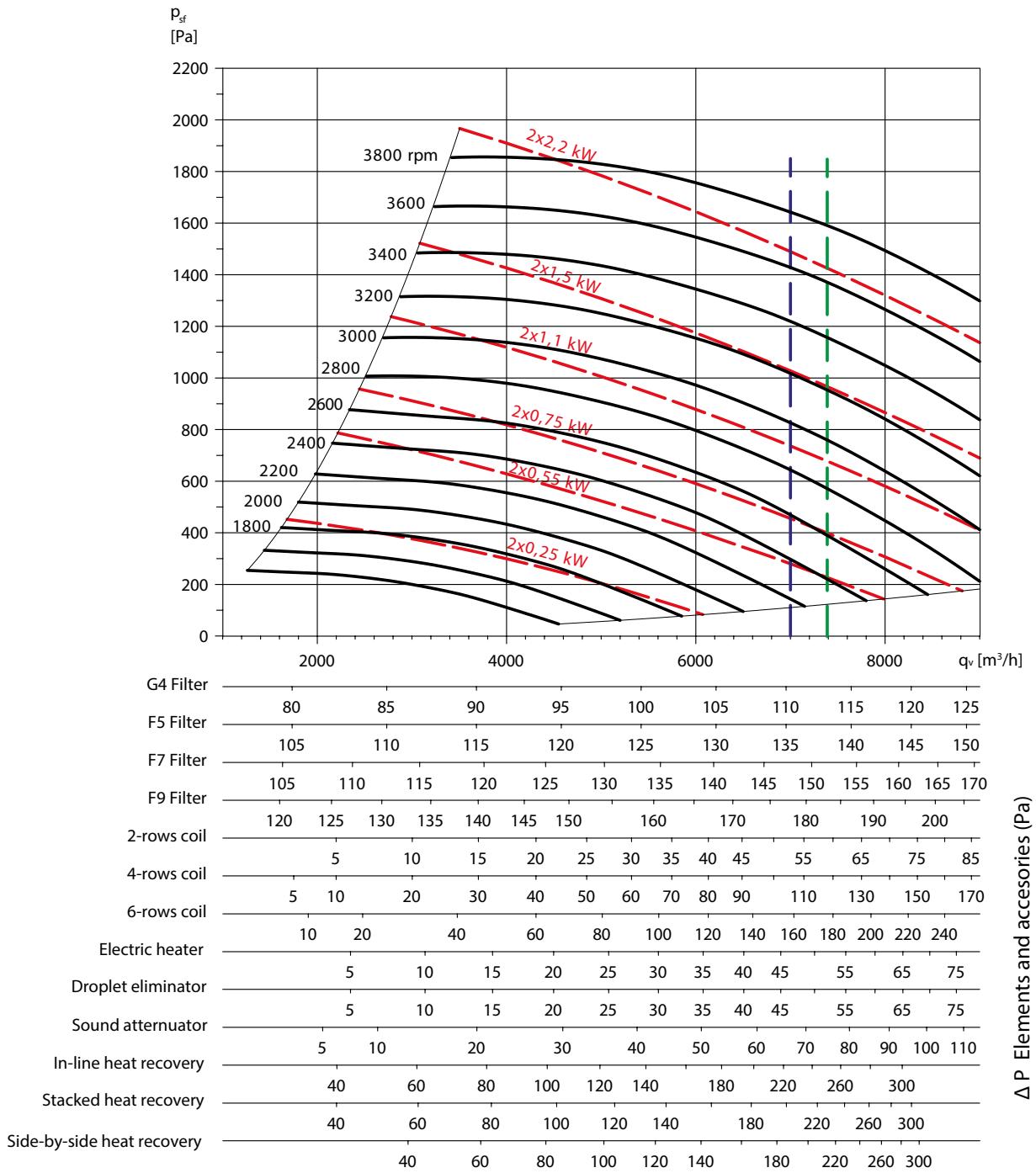

— — — — — Recommended working limit for cold coils = cooling coils  
 — — — — — Recommended working limit for heat coils = heating coils

THERMAL CHARACTERISTICS - UTBS 2

2-row heating coil									
Airflow		900 (m³/h)				1900 (m³/h)			
Water T. (°C)	Ext. T. (°C)	Power (kW)	Output T. (°C)	Water flow (l/s)	Water pressure drop (kPa)	Power (kW)	Output T. (°C)	Water flow (l/s)	Water pressure drop (kPa)
80/60	-10	12,6	32,1	0,15	3,4	20,8	22,9	0,25	8,5
	-5	11,9	34,7	0,14	3	19,6	25,9	0,23	7,6
	0	11,1	37,1	0,13	2,7	18,3	28,9	0,22	6,7
	5	10,3	39,5	0,12	2,3	17	31,9	0,2	5,8
	10	9,6	41,8	0,11	2	15,7	34,8	0,19	5
50/45	-10	9	19,9	0,43	25	14,8	13,4	0,71	63,1
	-5	8,3	22,5	0,4	21,5	13,6	16,5	0,65	54,1
	0	7,5	25	0,36	18	12,4	19,6	0,59	45,5
	5	6,8	27,5	0,32	14,8	11,2	22,6	0,53	37,4
	10	6	29,9	0,29	11,8	9,9	25,6	0,47	29,8

4-row heating coil									
Airflow		900 (m³/h)				1900 (m³/h)			
Water T. (°C)	Ext. T. (°C)	Power (kW)	Output T. (°C)	Water flow (l/s)	Water pressure drop (kPa)	Power (kW)	Output T. (°C)	Water flow (l/s)	Water pressure drop (kPa)
80/60	-10	19,3	54,3	0,23	4,6	34,1	43,9	0,41	13,1
	-5	18,2	55,6	0,22	4,1	32,2	45,8	0,39	11,7
	0	17	56,8	0,2	3,6	30,1	47,6	0,36	10,4
	5	15,9	57,9	0,19	3,2	28,1	49,3	0,34	9,1
	10	14,7	59	0,18	2,8	26	51	0,31	7,9
50/45	-10	13,5	34,8	0,64	32,8	23,9	27,7	1,14	94,3
	-5	12,4	36,2	0,59	28	22	27	1,05	80,7
	0	11,2	37,4	0,54	23,5	20	31,6	0,96	67,8
	5	10,1	38,7	0,48	19,4	18	33,4	0,86	55,8
	10	8,9	39,8	0,43	15,5	15,9	35,1	0,76	44,7

6-row heating coil									
Airflow		900 (m³/h)				1900 (m³/h)			
Water T. (°C)	Ext. T. (°C)	Power (kW)	Output T. (°C)	Water flow (l/s)	Water pressure drop (kPa)	Power (kW)	Output T. (°C)	Water flow (l/s)	Water pressure drop (kPa)
80/60	-10	22,4	64,6	0,27	2,3	41,5	55,5	0,5	7,2
	-5	21,1	65,3	0,25	2,1	39,1	56,7	0,47	6,5
	0	19,7	65,8	0,23	1,8	36,6	57,8	0,44	5,7
	5	18,4	66,3	0,22	1,6	34	58,8	0,41	5
	10	17,1	66,8	0,2	1,4	31,5	59,7	0,38	4,4
50/45	-10	15,6	41,8	0,74	16,6	29,1	35,9	1,39	52,7
	-5	14,3	45,5	0,68	14,1	26,7	37,1	0,28	44,9
	0	13	43,2	0,62	11,8	24,2	38,3	1,16	37,6
	5	11,6	43,8	0,56	9,7	21,8	39,4	1,04	30,8
	10	10,3	44,3	0,49	7,8	19,3	40,4	0,92	24,6

4-row cooling coil									
Airflow		900 (m³/h)				1500 (m³/h)			
Water T. (°C)	Ext. T. (°C)	Power (kW)	Output T. (°C)	Water flow (l/s)	Water pressure drop (kPa)	Power (kW)	Output T. (°C)	Water flow (l/s)	Water pressure drop (kPa)
7/12	25 / 50%	3,4	15,4 / 84,7%	0,16	2,5	5	16,4 / 80,2%	0,24	5,5
	27 / 50%	4,6	15,6 / 86%	0,22	4,6	6,6	17 / 81,1%	0,32	9,6
	32 / 50%	8,1	16,5 / 87,7%	0,39	14,3	11,7	18,4 / 82,7%	0,56	29,9

6-row cooling coil									
Airflow		900 (m³/h)				1500 (m³/h)			
Water T. (°C)	Ext. T. (°C)	Power (kW)	Output T. (°C)	Water flow (l/s)	Water pressure drop (kPa)	Power (kW)	Output T. (°C)	Water flow (l/s)	Water pressure drop (kPa)
7/12	25 / 50%	3,7	14,2 / 91,3%	0,18	1,2	5,8	14,9 / 87,6%	0,28	2,6
	27 / 50%	5,2	14,1 / 93,2%	0,25	2,1	8	15 / 89,3%	0,38	4,9
	32 / 50%	9,6	13,8 / 94,8%	0,46	7,1	14,2	15,6 / 90,8%	0,68	15,4

THERMAL CHARACTERISTICS - UTBS 3

2-row heating coil									
Airflow		1700 (m³/h)				3200 (m³/h)			
Water T. (°C)	Ext. T. (°C)	Power (kW)	Output T. (°C)	Water flow (l/s)	Water pressure drop (kPa)	Power (kW)	Output T. (°C)	Water flow (l/s)	Water pressure drop (kPa)
80/60	-10	27,9	33,9	0,3	6,7	38,2	25,8	0,46	14,7
	-5	23,5	36,4	0,28	6,1	36	28,8	0,43	13,2
	0	22	38,8	0,26	5,4	33,8	31,6	0,4	11,7
	5	20,5	41,1	0,25	4,7	31,4	34,5	0,38	10,3
	10	18,9	43,4	0,23	4,1	29,1	37,2	0,35	8,9
50/45	-10	17,4	20,8	0,83	48,2	26,8	15,1	1,28	105,8
	-5	16	23,3	0,77	41,5	24,7	18,1	1,18	91
	0	14,6	25,8	0,7	35	22,5	21,1	1,08	76,8
	5	13,2	28,2	0,63	28,9	20,2	24	0,98	63,4
	10	11,7	30,6	0,56	23,2	17,9	26,8	0,86	50,9

4-row heating coil									
Airflow		1700 (m³/h)				3200 (m³/h)			
Water T. (°C)	Ext. T. (°C)	Power (kW)	Output T. (°C)	Water flow (l/s)	Water pressure drop (kPa)	Power (kW)	Output T. (°C)	Water flow (l/s)	Water pressure drop (kPa)
80/60	-10	36,8	55	0,44	4,4	60	46,2	0,72	10,8
	-5	34,7	56,2	0,42	3,9	56,5	47,9	0,58	9,7
	0	32,5	57,4	0,39	3,5	52,9	49,6	0,63	8,6
	5	30,3	58,4	0,36	3,1	49,3	51,2	0,59	7,5
	10	28	59,5	0,34	2,7	45,6	52,7	0,55	6,5
50/45	-10	25,7	32,6	1,23	31,5	41,9	29,3	2	78
	-5	23,5	36,6	1,13	26,9	38,5	31,1	1,84	66,8
	0	21,4	37,8	1,02	22,6	35,1	32,9	1,68	56,1
	5	19,3	39	0,92	18,6	31,5	34,6	1,51	46,2
	10	17,1	40,1	0,82	14,9	27,9	36,2	1,34	36,8

6-row heating coil									
Airflow		1700 (m³/h)				3200 (m³/h)			
Water T. (°C)	Ext. T. (°C)	Power (kW)	Output T. (°C)	Water flow (l/s)	Water pressure drop (kPa)	Power (kW)	Output T. (°C)	Water flow (l/s)	Water pressure drop (kPa)
80/60	-10	43,7	67,1	0,52	8,3	74,5	59,8	0,89	22
	-5	41,2	67,7	0,49	7,4	70,2	60,8	0,84	19,7
	0	38,7	68,2	0,46	6,6	65,9	61,8	0,79	17,5
	5	36,1	68,7	0,43	5,9	61,5	62,6	0,74	15,5
	10	3,5	69,2	0,4	5,1	57,1	63,5	0,68	13,5
50/45	-10	29,9	42,8	1,43	57,1	51,2	38	2,45	153,1
	-5	27,5	43,5	1,31	48,8	47,1	39,1	2,25	130,5
	0	25	44,1	1,2	41	42,9	40,2	2,05	110,1
	5	2,5	44,6	1,07	33,8	38,5	41,1	1,84	90,7
	10	19,9	45,2	0,95	27,1	34,2	42	1,63	72,8

4-row cooling coil									
Airflow		1700 (m³/h)				2900 (m³/h)			
Water T. (°C)	Ext. T. (°C)	Power (kW)	Output T. (°C)	Water flow (l/s)	Water pressure drop (kPa)	Power (kW)	Output T. (°C)	Water flow (l/s)	Water pressure drop (kPa)
7/12	25 / 50%	6,2	15,45/85%	0,3	2,2	9,7	16,35/80,4%	0,46	5,3
	27 / 50%	8,7	15,56/86,5%	0,42	4,3	12,9	16,96/81,4%	0,62	9,4
	32 / 50%	15,5	16,32/88,1%	0,74	13,6	22,8	18,33/82,9%	1,09	29,4

6-row cooling coil									
Airflow		1700 (m³/h)				2900 (m³/h)			
Water T. (°C)	Ext. T. (°C)	Power (kW)	Output T. (°C)	Water flow (l/s)	Water pressure drop (kPa)	Power (kW)	Output T. (°C)	Water flow (l/s)	Water pressure drop (kPa)
7/12	25 / 50%	9,6	12,13/93,5%	0,46	7,2	14,4	13,41/89,2%	0,69	16,3
	27 / 50%	12,3	12,18/94,1%	0,59	12	18,6	13,65/89,9%	0,89	27,2
	32 / 50%	20	12,38/95,5%	0,96	31,5	30,7	14,20/91,6%	1,47	71



THERMAL CHARACTERISTICS - UTBS 5

2-row heating coil									
Airflow		2500 (m³/h)				4500 (m³/h)			
Water T. (°C)	Ext. T. (°C)	Power (kW)	Output T. (°C)	Water flow (l/s)	Water pressure drop (kPa)	Power (kW)	Output T. (°C)	Water flow (l/s)	Water pressure drop (kPa)
80/60	-10	36	33,2	0,43	4,9	56,6	25,7	0,64	10,1
	-5	33,9	35,7	0,41	4,4	50,5	28,7	0,6	9,1
	0	31,8	38,1	0,38	3,9	47,3	31,5	0,57	8
	5	29,6	40,5	0,35	3,4	44	34,3	0,53	7,1
	10	27,3	42,8	0,33	2,9	40,6	37,1	0,49	6,1
50/45	-10	25,4	20,5	1,21	35,7	37,8	15,2	1,81	74,3
	-5	23,3	23	1,12	30,6	34,8	18,2	1,67	63,7
	0	21,3	25,5	1,02	25,7	31,7	21,1	1,52	53,6
	5	19,1	27,9	0,92	21,2	28,5	24,1	1,36	44,2
	10	16,9	30,3	0,81	17	25,3	26,8	1,21	35,3

4-row heating coil									
Airflow		2500 (m³/h)				4500 (m³/h)			
Water T. (°C)	Ext. T. (°C)	Power (kW)	Output T. (°C)	Water flow (l/s)	Water pressure drop (kPa)	Power (kW)	Output T. (°C)	Water flow (l/s)	Water pressure drop (kPa)
80/60	-10	54,3	55,2	0,65	6,1	85,6	47	1,02	14,2
	-5	51,2	56,4	0,61	5,5	80,6	48,7	0,96	12,7
	0	48	57,6	0,57	4,9	75,6	50,4	0,9	11,3
	5	44,7	58,7	0,54	4,3	70,4	51,9	0,84	9,9
	10	41,4	59,7	0,5	3,7	65,2	53,5	0,78	8,6
50/45	-10	37,7	35,3	1,8	43,7	59,6	29,7	2,85	102,4
	-5	34,7	36,6	1,66	37,4	54,8	31,5	2,62	87,5
	0	31,5	37,8	1,51	31,3	49,9	33,3	2,39	73,5
	5	28,3	39	1,36	25,8	44,9	39,4	2,15	60,4
	10	25,1	40,1	1,2	20,6	39,8	36,5	1,9	48,2

6-row heating coil									
Airflow		2500 (m³/h)				4500 (m³/h)			
Water T. (°C)	Ext. T. (°C)	Power (kW)	Output T. (°C)	Water flow (l/s)	Water pressure drop (kPa)	Power (kW)	Output T. (°C)	Water flow (l/s)	Water pressure drop (kPa)
80/60	-10	64	66,8	0,77	8,6	105,1	60,1	1,26	21,5
	-5	60,4	67,4	0,72	7,7	99,1	31,1	1,19	19,3
	0	56,7	68	0,68	6,9	93	62	1,11	17,1
	5	52,9	68,5	0,63	6,1	86,8	62,9	1,04	15,1
	10	49,1	69	0,59	5,3	80,6	63,7	0,96	13,1
50/45	-10	43,9	42,7	2,1	59,9	72,4	38,3	3,46	151,5
	-5	40,3	43,3	1,93	51,1	66,5	39,3	3,18	129,3
	0	36,6	44	1,75	42,9	60,5	4	2,89	108,4
	5	33	44,5	1,58	325,3	54,4	41,3	2,6	89,2
	10	29,2	45,1	1,4	28,3	48,3	42,2	2,31	71,4

4-row cooling coil									
Airflow		2500 (m³/h)				4000 (m³/h)			
Water T. (°C)	Ext. T. (°C)	Power (kW)	Output T. (°C)	Water flow (l/s)	Water pressure drop (kPa)	Power (kW)	Output T. (°C)	Water flow (l/s)	Water pressure drop (kPa)
7/12	25 / 50%	9,7	15,1 / 853%	0,5	3,4	14,2	16 / 81,1%	0,68	7,4
	27 / 50%	13,5	15,2 / 86,4%	0,65	6,7	18,7	16,6 / 81,9%	0,9	12,8
	32 / 50%	23,2	16,1 / 88,1%	1,11	19,6	32,6	17,9 / 83,6%	1,56	38,8

6-row cooling coil									
Airflow		2500 (m³/h)				4000 (m³/h)			
Water T. (°C)	Ext. T. (°C)	Power (kW)	Output T. (°C)	Water flow (l/s)	Water pressure drop (kPa)	Power (kW)	Output T. (°C)	Water flow (l/s)	Water pressure drop (kPa)
7/12	25 / 50%	13,9	12,3 / 93,4%	0,66	7,2	21,7	13,6 / 88,6%	1,04	17,6
	27 / 50%	18	12,3 / 94%	0,86	12,1	28,1	13,9 / 89,3%	1,35	29,5
	32 / 50%	29,2	12,5 / 95,4%	1,4	31,9	46,8	14,5 / 91,1%	2,24	78,3

THERMAL CHARACTERISTICS - UTBS 8

2-row heating coil									
Airflow		4000 (m³/h)				7900 (m³/h)			
Water T. (°C)	Ext. T. (°C)	Power (kW)	Output T. (°C)	Water flow (l/s)	Water pressure drop (kPa)	Power (kW)	Output T. (°C)	Water flow (l/s)	Water pressure drop (kPa)
80/60	-10	58,4	33,8	0,7	5,9	92,5	25,1	1,11	13,7
	-5	55	36,3	0,66	5,3	87,2	28,1	1,04	12,3
	0	51,5	38,7	0,62	4,7	81,7	31	0,98	10,9
	5	48	41	0,57	4,1	76	33,9	0,91	9,6
	10	44,4	43,3	0,53	3,6	70,2	36,7	0,84	8,3
50/45	-10	41	20,7	1,96	42,7	65	14,7	3,11	99,5
	-5	37,7	23,3	1,8	36,6	59,8	17,7	2,86	85,4
	0	34,3	25,8	1,64	30,8	54,5	20,7	2,61	72
	5	30,9	28,2	1,48	25,4	49,1	23,6	2,35	59,3
	10	27,4	30,5	1,31	20,4	43,5	26,5	2,08	47,5

4-row heating coil									
Airflow		4000 (m³/h)				7900 (m³/h)			
Water T. (°C)	Ext. T. (°C)	Power (kW)	Output T. (°C)	Water flow (l/s)	Water pressure drop (kPa)	Power (kW)	Output T. (°C)	Water flow (l/s)	Water pressure drop (kPa)
80/60	-10	86,4	54,8	1,03	4,7	145,8	45,4	1,74	12,5
	-5	81,4	56	0,97	4,2	137,2	47,1	1,64	11,1
	0	76,2	57,2	0,91	3,7	128,6	48,8	1,54	9,8
	5	71	58,3	0,85	3,2	119,7	50,5	1,43	8,6
	10	65,7	59,3	0,79	2,8	110,7	52	1,32	7,4
50/45	-10	60,3	35,2	2,88	34,1	102,2	28,8	4,89	92,2
	-5	55,4	36,5	2,65	29,1	93,9	30,7	4,49	78,9
	0	50,3	37,8	2,41	24,3	85,4	32,4	4,09	65,7
	5	45,2	38,9	2,16	19,9	76,8	34,2	3,67	53,8
	10	40,1	40	1,92	15,9	68	35,8	3,25	42,7

6-row heating coil									
Airflow		4000 (m³/h)				7900 (m³/h)			
Water T. (°C)	Ext. T. (°C)	Power (kW)	Output T. (°C)	Water flow (l/s)	Water pressure drop (kPa)	Power (kW)	Output T. (°C)	Water flow (l/s)	Water pressure drop (kPa)
80/60	-10	102,6	67	1,23	8,2	181,9	59,1	2,18	23,8
	-5	96,7	67,5	1,16	7,4	171,5	60,1	2,05	21,3
	0	90,8	68,1	1,09	6,6	160,9	61,1	1,92	19
	5	84,8	68,6	1,01	5,8	150,2	62	1,8	16,7
	10	78,7	69	0,94	5	139,3	62,9	1,67	14,5
50/45	-10	70,4	42,8	3,36	57,6	125,4	37,6	5,99	168,7
	-5	64,6	43,4	3,09	49,2	115,1	38,7	5,51	144,2
	0	59,7	44	2,81	41,1	104,8	39,8	5,01	120,8
	5	52,8	44,6	2,53	33,8	94,3	40,8	4,51	92,2
	10	46,8	45,1	2,24	27,1	83,6	41,8	4	79,4

4-row cooling coil									
Airflow		4000 (m³/h)				7000 (m³/h)			
Water T. (°C)	Ext. T. (°C)	Power (kW)	Output T. (°C)	Water flow (l/s)	Water pressure drop (kPa)	Power (kW)	Output T. (°C)	Water flow (l/s)	Water pressure drop (kPa)
7/12	25 / 50%	13,3	16 / 84%	0,6	1,9	22,3	16,6 / 79,9%	1,07	5,3
	27 / 50%	19,5	15,9 / 86,5%	0,93	4	30,1	17,1 / 81,2%	1,44	9,7
	32 / 50%	36	16,5 / 88,1%	1,72	13,8	53,8	18,6 / 82,7%	2,57	30,8

6-row cooling coil									
Airflow		4000 (m³/h)				7000 (m³/h)			
Water T. (°C)	Ext. T. (°C)	Power (kW)	Output T. (°C)	Water flow (l/s)	Water pressure drop (kPa)	Power (kW)	Output T. (°C)	Water flow (l/s)	Water pressure drop (kPa)
7/12	25 / 50%	22	12,3 / 93,4%	1,05	6,7	34	13,6 / 89%	1,63	15,9
	27 / 50%	28,7	12,3 / 84,1%	1,37	11,4	44,1	13,8 / 89,7%	2,11	26,7
	32 / 50%	46,8	12,5 / 95,5%	2,24	30,2	73,2	14,4 / 91,4%	3,5	71,6

ACOUSTIC CHARACTERISTICS - UTBS 2

Sound power levels at inlet (Lw(A))										
Airflow (m³/h)	Total pressure (Pa)	Frequency (Hz)								
		63	125	250	500	1000	2000	4000	8000	Total dB(A)
500	200	45	52	57	53	49	43	40	35	60
	400	53	60	65	60	56	50	47	42	68
1000	200	45	52	57	53	49	43	40	35	60
	400	51	58	63	59	55	49	46	41	66
	600	57	64	69	64	60	54	51	46	70
1500	800	60	67	72	68	64	58	55	50	75
	200	51	58	63	59	55	49	46	41	66
	400	53	60	65	61	57	51	48	43	68
	600	56	63	68	64	60	54	51	46	71
2000	800	59	66	71	66	62	56	53	48	74
	200	57	64	69	65	61	55	52	47	72
	400	58	65	70	65	61	55	52	47	72
	600	59	66	71	66	62	56	53	48	74

Sound power levels at outlet (Lw(A))										
Airflow (m³/h)	Total pressure (Pa)	Frequency (Hz)								
		63	125	250	500	1000	2000	4000	8000	Total dB(A)
500	200	36	48	56	59	61	62	57	54	67
	400	44	56	64	66	68	69	64	61	74
1000	200	36	48	56	59	61	62	57	54	67
	400	42	54	62	65	67	68	63	60	73
	600	48	60	68	70	72	73	68	65	78
1500	800	51	63	71	74	76	77	72	69	82
	200	42	54	62	65	67	68	63	60	73
	400	44	56	64	67	69	70	65	62	75
	600	47	59	67	70	72	73	68	65	77
2000	800	50	62	70	72	74	75	70	67	80
	200	48	60	68	71	73	74	69	66	79
	400	49	61	69	71	73	74	69	66	79
	600	50	62	70	72	74	75	70	67	80

Sound power levels radiated (Lw(A))										
Airflow (m³/h)	Total pressure (Pa)	Frequency (Hz)								
		63	125	250	500	1000	2000	4000	8000	Total dB(A)
500	200	32	36	43	38	44	44	39	35	50
	400	40	44	51	46	52	52	47	43	57
1000	200	32	36	43	38	44	44	39	35	50
	400	38	42	49	44	50	50	45	41	56
	600	44	48	55	49	55	55	50	46	61
1500	800	47	51	58	53	59	59	54	50	65
	200	38	42	49	44	50	50	45	41	56
	400	40	44	51	46	52	52	47	43	58
	600	43	47	54	49	55	55	50	46	61
2000	800	46	50	57	51	57	57	52	48	63
	200	44	48	55	50	56	56	51	47	62
	400	45	49	56	50	56	56	51	47	62
	600	46	50	57	51	57	57	52	48	63

ACOUSTIC CHARACTERISTICS - UTBS 3

Sound power levels at inlet (Lw(A))										
Airflow (m³/h)	Total pressure (Pa)	Frequency (Hz)								
		63	125	250	500	1000	2000	4000	8000	Total dB(A)
1000	400	51	58	63	59	55	49	46	41	66
	600	57	64	69	64	60	54	51	46	72
	800	60	67	72	68	64	58	55	50	75
2000	400	55	62	67	62	58	52	49	44	70
	800	60	67	72	67	63	57	54	49	75
	1200	64	71	76	72	68	62	59	54	79
	1600	68	75	80	76	72	66	63	58	83
3000	400	62	69	74	70	66	60	57	52	77
	800	63	70	75	71	67	61	58	53	78
	1200	65	72	77	73	69	63	60	55	80
	1600	68	75	80	75	71	65	62	57	82
3500	400	65	72	77	73	69	63	60	55	80
	800	66	73	78	73	69	63	60	55	81
	1200	67	74	79	74	70	64	61	56	82

Sound power levels at outlet (Lw(A))										
Airflow (m³/h)	Total pressure (Pa)	Frequency (Hz)								
		63	125	250	500	1000	2000	4000	8000	Total dB(A)
1000	400	42	54	62	65	67	68	63	60	73
	600	48	60	68	70	72	73	68	65	78
	800	51	63	71	74	76	77	72	69	82
2000	400	46	58	66	68	70	71	66	63	79
	800	51	63	71	73	75	76	71	68	81
	1200	55	67	75	78	80	81	76	73	86
	1600	59	71	79	82	84	85	80	77	90
3000	400	53	65	73	76	78	79	74	71	84
	800	54	66	74	77	79	80	75	72	85
	1200	56	68	76	79	81	82	77	74	87
	1600	59	71	79	81	83	84	79	76	89
3500	400	56	68	76	79	81	82	77	74	87
	800	57	69	77	79	81	82	77	74	87
	1200	58	70	78	80	82	83	78	75	88

Sound power levels radiated (Lw(A))										
Airflow (m³/h)	Total pressure (Pa)	Frequency (Hz)								
		63	125	250	500	1000	2000	4000	8000	Total dB(A)
1000	400	38	42	49	44	50	50	45	41	56
	600	44	48	55	49	55	55	50	46	61
	800	47	51	58	53	59	59	54	50	65
2000	400	42	46	53	48	54	54	49	45	59
	800	47	51	58	53	59	59	54	50	64
	1200	52	56	63	57	63	63	58	54	69
	1600	56	60	67	61	67	67	62	58	73
3000	400	49	53	60	55	61	61	56	52	67
	800	50	54	61	56	62	62	57	53	68
	1200	52	56	63	58	64	64	59	55	70
	1600	55	59	66	60	66	66	61	57	72
3500	400	53	57	64	58	64	64	59	55	70
	800	53	57	64	58	64	64	59	55	70
	1200	54	58	65	60	66	66	61	57	71

ACOUSTIC CHARACTERISTICS - UTBS 5

Sound power levels at inlet (Lw(A))										
Airflow (m³/h)	Total pressure (Pa)	Frequency (Hz)								
		63	125	250	500	1000	2000	4000	8000	Total dB(A)
2000	400	56	63	68	64	60	54	51	46	71
	800	65	72	77	72	68	62	59	54	79
3000	400	56	63	68	63	59	53	50	45	70
	800	64	71	76	71	67	61	58	53	79
	1200	69	76	81	76	72	66	63	58	84
	1600	72	79	84	80	76	70	67	62	87
4000	400	58	65	70	65	61	55	52	47	73
	800	63	70	75	70	66	60	57	52	78
	1200	67	74	79	75	71	65	62	57	80
	1600	71	78	83	79	75	69	66	61	86
5000	400	61	68	73	69	65	59	56	51	76
	800	64	71	76	72	68	62	59	54	79
	1200	67	74	79	75	71	65	62	57	82
	1600	70	77	82	78	74	68	65	60	85

Sound power levels at outlet (Lw(A))										
Airflow (m³/h)	Total pressure (Pa)	Frequency (Hz)								
		63	125	250	500	1000	2000	4000	8000	Total dB(A)
2000	400	47	59	67	70	72	73	68	65	78
	800	56	68	76	78	80	81	76	73	86
3000	400	47	59	67	69	71	72	67	64	77
	800	55	67	75	77	79	80	75	72	85
	1200	60	72	80	82	84	85	80	77	90
	1600	63	75	83	86	88	89	84	81	94
4000	400	49	61	69	71	73	74	69	66	79
	800	54	66	74	76	78	79	74	71	84
	1200	58	70	78	81	83	84	79	76	89
	1600	62	74	82	85	87	88	83	80	93
5000	400	52	64	72	75	77	78	73	70	83
	800	55	67	75	78	80	81	76	73	86
	1200	58	70	78	81	83	84	79	76	89
	1600	61	73	81	84	86	87	82	79	92

Sound power levels radiated (Lw(A))										
Airflow (m³/h)	Total pressure (Pa)	Frequency (Hz)								
		63	125	250	500	1000	2000	4000	8000	Total dB(A)
2000	400	44	48	55	49	55	55	50	46	61
	800	52	56	63	57	63	63	58	54	69
3000	400	43	47	54	48	54	54	49	45	60
	800	51	55	62	56	62	62	57	53	68
	1200	56	60	67	61	67	67	62	58	73
	1600	59	63	70	65	71	71	66	62	77
4000	400	45	49	56	51	57	57	52	48	62
	800	50	54	61	55	61	61	56	52	67
	1200	55	59	66	60	66	66	61	57	72
	1600	59	63	70	64	70	70	65	61	76
5000	400	49	53	60	54	60	60	55	51	66
	800	51	55	62	57	63	63	58	54	69
	1200	54	58	65	60	66	66	61	57	72
	1600	57	61	68	63	69	69	64	60	75

ACOUSTIC CHARACTERISTICS - UTBS 8

Sound power levels at inlet (Lw(A))										
Airflow (m³/h)	Total pressure (Pa)	Frequency (Hz)								
		63	125	250	500	1000	2000	4000	8000	Total dB(A)
3000	400	56	63	68	64	60	54	51	46	71
	800	65	72	77	73	69	63	60	55	80
	1200	70	77	82	77	73	67	64	59	85
5000	400	59	66	71	66	62	56	53	48	74
	800	64	71	76	71	67	61	58	53	79
	1200	69	76	81	76	72	66	63	58	83
6000	400	62	69	74	69	65	59	56	51	77
	800	65	72	77	72	68	62	59	54	80
	1200	68	75	80	76	72	66	63	58	83
	1600	71	78	83	79	75	69	66	61	86
7000	400	65	72	77	72	68	62	59	54	80
	800	66	73	78	74	70	64	61	56	81
	1200	69	76	81	76	72	66	63	58	84
8000	400	67	74	79	75	71	65	62	57	82
	800	68	75	80	76	72	66	63	58	83
	1200	70	77	82	77	73	67	64	59	85

Sound power levels at outlet (Lw(A))										
Airflow (m³/h)	Total pressure (Pa)	Frequency (Hz)								
		63	125	250	500	1000	2000	4000	8000	Total dB(A)
3000	400	47	59	67	70	72	73	68	65	78
	800	56	68	76	79	81	82	77	74	87
	1200	61	73	81	83	85	86	81	78	91
5000	400	50	62	70	72	74	75	70	67	80
	800	55	67	75	77	79	80	75	72	85
	1200	60	72	80	82	84	85	80	77	90
6000	400	53	65	73	75	77	78	73	70	83
	800	56	68	76	78	80	81	76	73	86
	1200	59	71	79	82	84	85	80	77	90
	1600	62	74	82	85	87	88	83	80	93
7000	400	56	68	76	78	80	81	76	73	86
	800	57	69	77	80	82	83	78	75	88
	1200	60	72	80	82	84	85	80	77	90
8000	400	58	70	78	81	83	84	79	76	89
	800	59	71	79	82	84	85	80	77	90
	1200	61	73	81	83	85	86	81	78	91

Sound power levels radiated (Lw(A))										
Airflow (m³/h)	Total pressure (Pa)	Frequency (Hz)								
		63	125	250	500	1000	2000	4000	8000	Total dB(A)
3000	400	43	47	54	49	55	55	50	46	61
	800	52	56	63	58	64	64	59	55	70
	1200	57	61	68	63	69	69	64	60	74
5000	400	46	50	57	51	57	57	52	48	63
	800	51	55	62	56	62	62	57	53	68
	1200	56	60	67	61	67	67	62	58	73
6000	400	49	53	60	54	60	60	55	51	66
	800	52	56	63	57	63	63	58	54	69
	1200	55	59	66	61	67	67	62	58	73
	1600	58	62	69	64	70	70	65	61	76
7000	400	52	56	63	57	63	63	58	54	69
	800	53	57	64	59	65	65	60	56	71
	1200	56	60	67	61	67	67	62	58	73
8000	400	55	59	66	60	66	66	61	57	72
	800	55	59	66	61	67	67	62	58	73
	1200	57	61	68	62	68	68	63	59	74

**DIMENSIONS (mm)**

Each model has his width and height dimensions regardless of its configuration. However, the unit's length depends on the section configuration. The table below indicates the length of the units according to the configuration.

Nomenclature	Description
V	Fan
BC	Hot water coil (2, 4 or 6 rows)
BF	Cold water coil
BE	Electric heater
PF	Pre-filter (G4/F5)
FAE	High-Efficiency Filter: (F7, F9)

750 mm

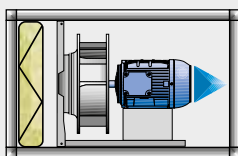

Unit consisting of a section with a pre-filter (G4 or F5) and another section with fan(s).

969 mm

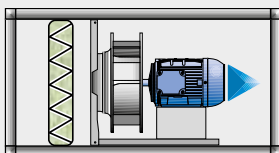

Unit consisting of a section with a high-efficiency filter and another section with fan(s).

FAE

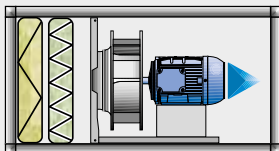

Unit consisting of a section with a pre-filter and a high-efficiency filter and another section with fan(s).

PF FAE

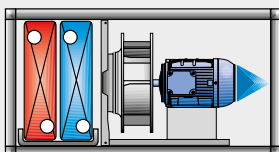

Unit consisting of a section with coils and a section with fan(s). The coil section may contain a maximum of 8 rows in any combination.

BC/BE BF

1205 mm

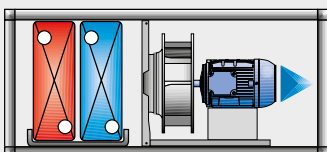

Unit consisting of a section with coils and a section with fan(s). The coil section contains a maximum of 10 rows in any combination.

BC/BE BF

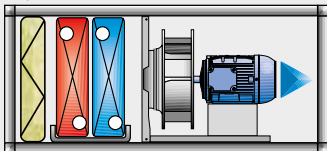

Unit consisting of a section with pre-filter, a section with coils and a section with fan(s). The coil section may contain a maximum of 8 rows in any combination.

PF BC/BE BF

1455 mm

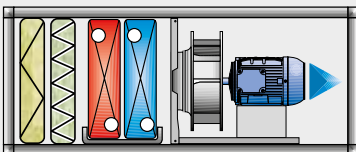

Unit consisting of a section with a pre-filter and a high-efficiency filter, a section with coils and a section with fan(s). The coil section may contain a maximum of 8 rows in any combination.

PF FAE BC/BE BF

### WEIGHTS AND DIMENSIONS

The table below indicates the weight of the main boxes according to size and to the configured components. The total weight is obtained by adding the weight of the casing and the components installed in the climate control unit.

Model		UTBS-2	UTBS-3	UTBS-5	UTBS-8
Fans	-	-	-	-	-
	0,25 kW	16	20	40*	46*
	0,37 kW	17	-	-	-
	0,55 kW	18	22	44*	50*
	0,75 kW	-	25	50*	56*
	1,1 kW	-	26	52*	58*
	1,5 kW	-	29	58*	72*
	2,2 kW	-	32	64*	78*
Coils	BC2	6	9	12	14
	BC4 / BF4	9	13	18	26
	BF6	11	18	24	36
	BE	6	9	12	14
Filters	G4/F5	2	4	6	8
	FAE	4	6	8	10
Casing	750 mm	35	50	60	75
	969 mm	45	60	75	95
	1205 mm	55	75	95	120
	1455 mm	70	90	115	145

\* The weight includes both fans.

### EXAMPLE

UTBS-3 climate control unit with G4 pre-filter, 2-row heating coil and 4-row cooling coil, 1.1 Kw fans. Firstly, and depending on the unit's configuration, the dimensions of the casing will be: 1205 mm.

Weight of the casing = 75 kg  
 Weight of the hot water coil 2 rows = 9 kg  
 Weight of the cold water coil 4 rows = 13 kg  
 Weight of the filters = 4 kg  
 Weight of the fans = 26 kg

TOTAL WEIGHT: 127 KG

### Connection side

To determine the side connections we look in direction of airflow.

Model	Width (mm)	Height (mm)
UTBS-2	750	360
UTBS-3	1100	410
UTBS-5	1500	410
UTBS-8	1900	500

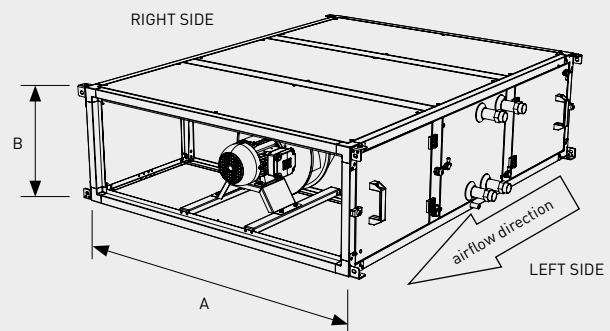



**OPTIONAL MODULES**

OPTIONAL MODULES may be added to the main casing to complete the climate control unit with additional components. The modules will follow the width and height dimensions of the main module. The construction of the OPTIONAL MODULES is the same as with the main module, maintaining the same tightness and thermal bridge level. The connection between the modules and the main box is joined with external brackets and designed to hold the weight.

**PLENUM BOX (PB)**

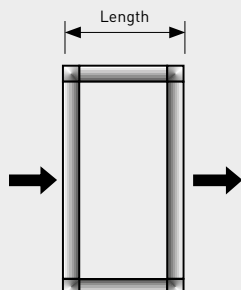

Model	Length (mm)	Total weight (kg)
UTBS-2	750	16
UTBS-3	750	25
UTBS-5	750	32
UTB S-8	750	49

**FILTERING BOX (FB)**

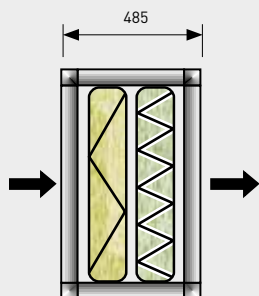

Module with the possibility to introduce a pre-filter and a high-efficiency filter. For all the models, the module's length is 485 mm.

Model	Box weight (kg)	Pre-filter		High-efficiency filter	
		Units	Weight (kg)	Units	Weight (kg)
UTBS-2	20	1	2	1	3
UTBS-3	27	1	4	1	5
UTBS-5	34	2	6	2	7
UTB S-8	43	2	8	2	9

**ELECTRIC HEATER BOX (EB)**

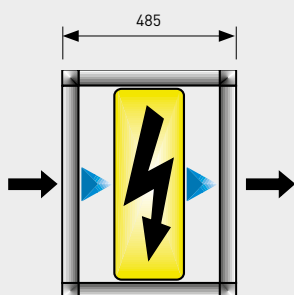

Module with an electric heater. The electric heater includes an anti-radiation screen upstream within the module. For all the models, the module's length is 485 mm.

UTBS	Power offer proposal			Total weight (kg)
2	4,5 kW/1st.	15 Kw/2st.		25
3	6,0 kW/1st.	15,0 kW/2st.	24 Kw/2st.	35
5	9,0 kW/2st.	15,0 kW/2st.	36 Kw/3st.	46
8	15,0 kW/2st.	24 kW/2st.	45 Kw/3st.	60

**WATER COIL BOX**

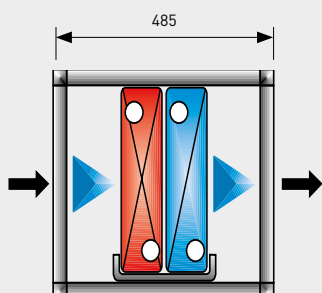

Optional module with water coils. Cold and hot water coils can be included in the module. If cold water coils are installed, the module will have a stainless-steel condensates tray and a demister.

It has the same thermal specifications as the coils in the main box.

The module can incorporate up to 10 coil rows. For all models, the module's length is 485 mm.

### OPTIONAL MODULES

#### 1 DAMPER BOX (1M)

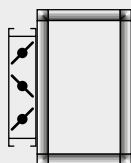

Front damper  
REF: 1MA

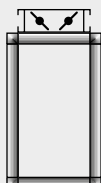

Top or bottom damper  
Ref: 1MB

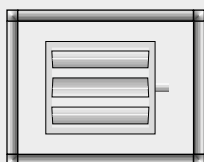

Side damper  
Ref: 1MC

Module with one regulating damper.  
The damper can be activated manually or with servomotors.

Model	1MA, 1MB		1MC	
	Weight (kg)	Length (mm)	Weight (kg)	Length (mm)
UTBS-2	22	360	39	750
UTBS-3	31	410	52	750
UTBS-5	44	410	106	1205
UTBS-8	68	500	137	1205

Model	Top (l x h)	Front (l x h)	Side (l x h)
UTBS-2	400 x 210	400 x 210	400 x 210
UTBS-3	800 x 210	800 x 210	450 x 310
UTBS-5	1200 x 210	1200 x 210	750 x 310
UTBS-8	1600 x 310	1600 x 310	900 x 410

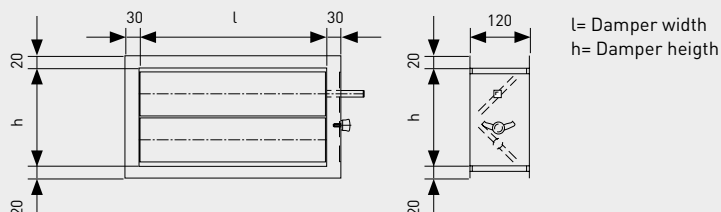

#### 2 WAY MIXING BOX (2M)

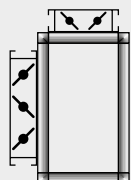

Front damper + top damper  
Ref: 2MA

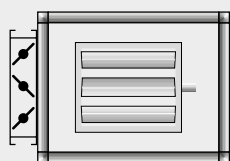

Front damper + side damper  
Ref: 2MB

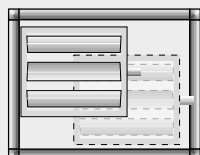

Opposite side dampers  
Ref: 2MD

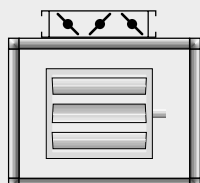

Top damper + side damper  
Ref: 2ME

Mixing module with two dampers.  
The dampers can be activated manually or with servomotors.

Model	2MA		2MB, 2MD, 2ME	
	Weight (kg)	Length (mm)	Weight (kg)	Length (mm)
UTBS-2	22	360	39	750
UTBS-3	31	410	52	750
UTBS-5	44	410	106	1205
UTBS-8	68	500	137	1205

Model	Top (l x h)	Front (l x h)	Side (l x h)
UTBS-2	400 x 210	400 x 210	400 x 210
UTBS-3	800 x 210	800 x 210	450 x 310
UTBS-5	1200 x 210	1200 x 210	750 x 310
UTBS-8	1600 x 310	1600 x 310	900 x 410

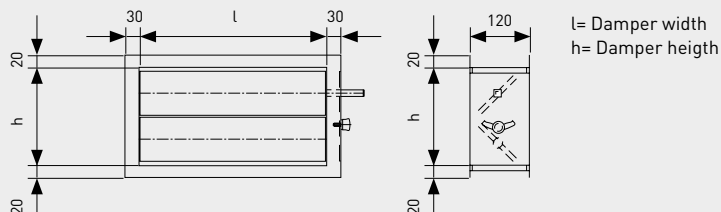

**OPTIONAL MODULES**

**SILENCER BOX (SIL)**

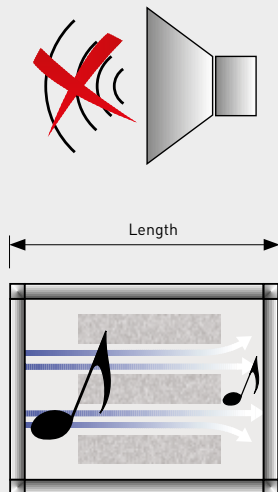

Acoustic attenuation boxes. Two baffle lengths available: 600 mm and 900 mm. Baffles with fireproof glass wool insulation, 200 mm wide, covered with highly resistant glass cloth for easy cleaning.

Model	Length 750 mm Baffles 600 mm		Length 1100 mm Baffles 900 mm	
	Baffles	Total weight (kg)	Baffles	Total weight (kg)
UTBS-2	2	34	2	39
UTBS-3	3	49	3	53
UTBS-5	4	65	4	86
UTBS-8	5	87	5	107

**Silencer acoustic attenuation (in dB)**

Length	63Hz	125Hz	250Hz	500Hz	1000Hz	2000Hz	4000Hz	8000Hz
750	1	2,3	6	11	15	16	9	1,5
1100	1,5	3,4	9	16,5	22,5	24	13,5	2,3

### OPTIONAL MODULES

#### IN-LINE FREE-COOLING BOX (HF)

Mixing module with three dampers to connect aligned units.  
The dampers can be activated manually or with a servomotor.

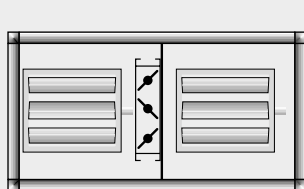

Side dampers  
on the same side  
Ref: HFA

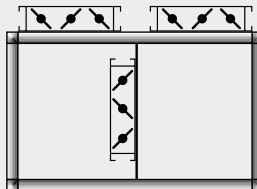

Top dampers  
Ref: HFB

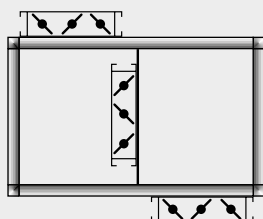

Top damper +  
bottom damper  
Ref: HFC

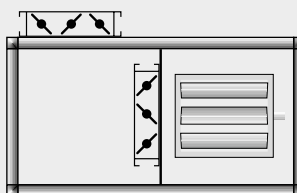

Top damper +  
side damper  
Ref: HFD

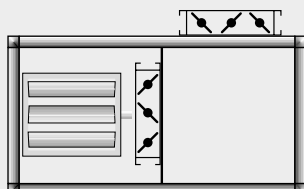

Top dampers +  
side damper  
Ref: HFE

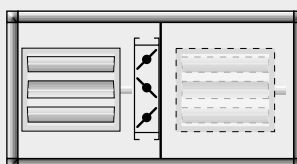

Side dampers on  
opposite sides  
Ref: HFF

Model	HFA, HFF		HFB, HFC		HFD, HFE	
	Weight (kg)	Length (mm)	Weight (kg)	Length (mm)	Weight (kg)	Length (mm)
UTBS-2	56	1205	36	750	56	1205
UTBS-3	93	1455	49	750	77	1205
UTBS-5	155	1940	80	969	118	1455
UTBS-8	223	2207	102	969	172	1691

Model	Interior (l x h)	Side (l x h)	Top (l x h)
UTBS-2	400 x 210	400 x 210	400 x 210
UTBS-3	800 x 210	450 x 310	800 x 210
UTBS-5	1200 x 210	750 x 310	1200 x 210
UTBS-8	1600 x 310	900 x 410	1600 x 310

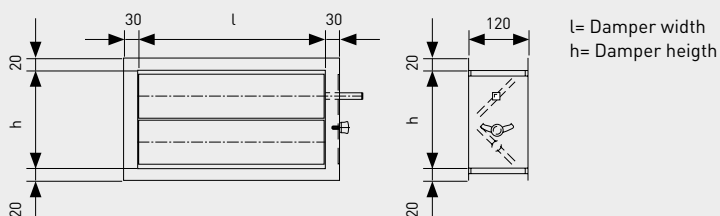

#### Example

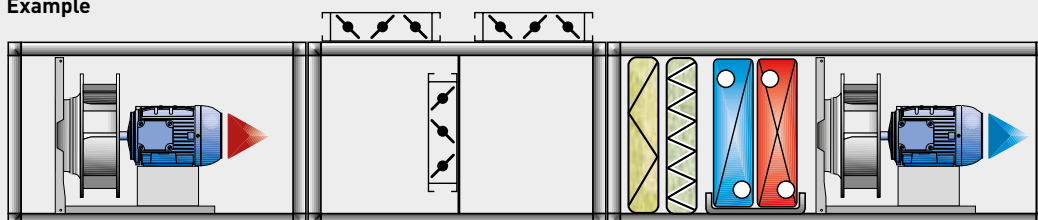

OPTIONAL MODULES

STACKED FREE-COOLING BOX (VF)

Mixing module with three dampers to connect the units in high ceilings.  
The dampers can be activated manually or with a servomotor.

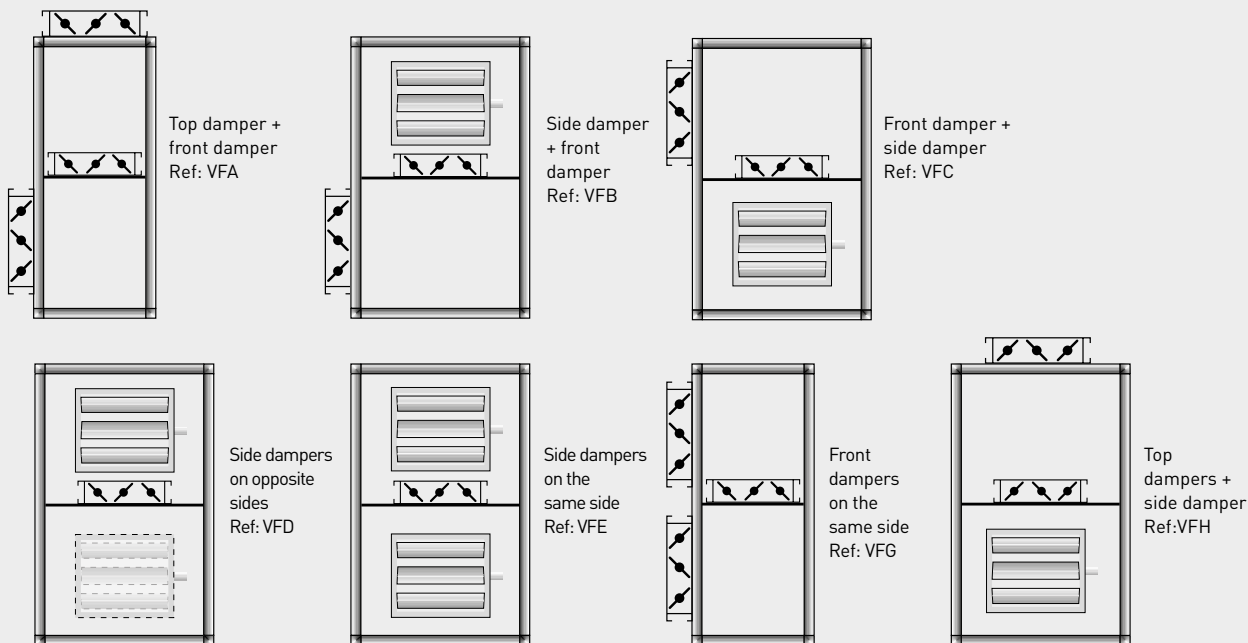

Model	VFA, VFF, VFG		VFB, VFC, VFD, VFE, VFH	
	Weight (kg)	Length (mm)	Weight (kg)	Length (mm)
UTBS-2	33	360	49	750
UTBS-3	43	410	66	750
UTBS-5	64	410	123	1205
UTBS-8	98	500	157	1205

Model	Interior (l x h)	Side (l x h)	Front (l x h)	Top (l x h)
UTBS-2	400 x 210	400 x 210	400 x 210	400 x 210
UTBS-3	800 x 210	450 x 310	800 x 210	800 x 210
UTBS-5	1200 x 210	750 x 310	1200 x 210	1200 x 210
UTBS-8	1600 x 310	900 x 410	1600 x 310	1600 x 310

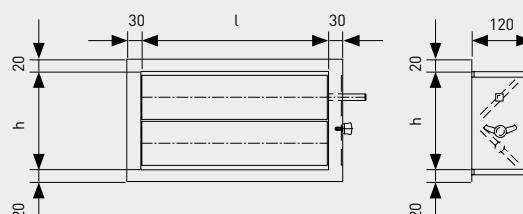

l= Damper width  
h= Damper height

Example

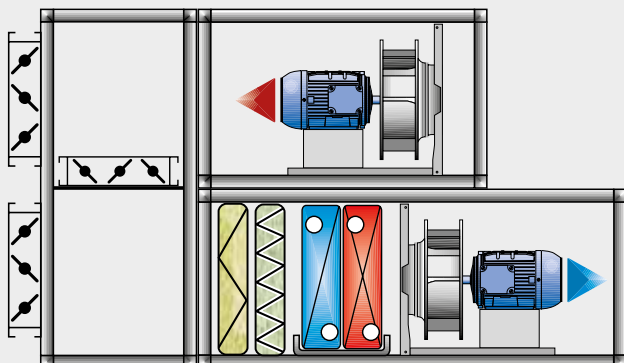

### OPTIONAL MODULES

#### SIDE-BY-SIDE FREE-COOLING BOX (PF)

Mixing module with three dampers to connect the units in high ceilings. The dampers can be activated manually or with a servomotor.

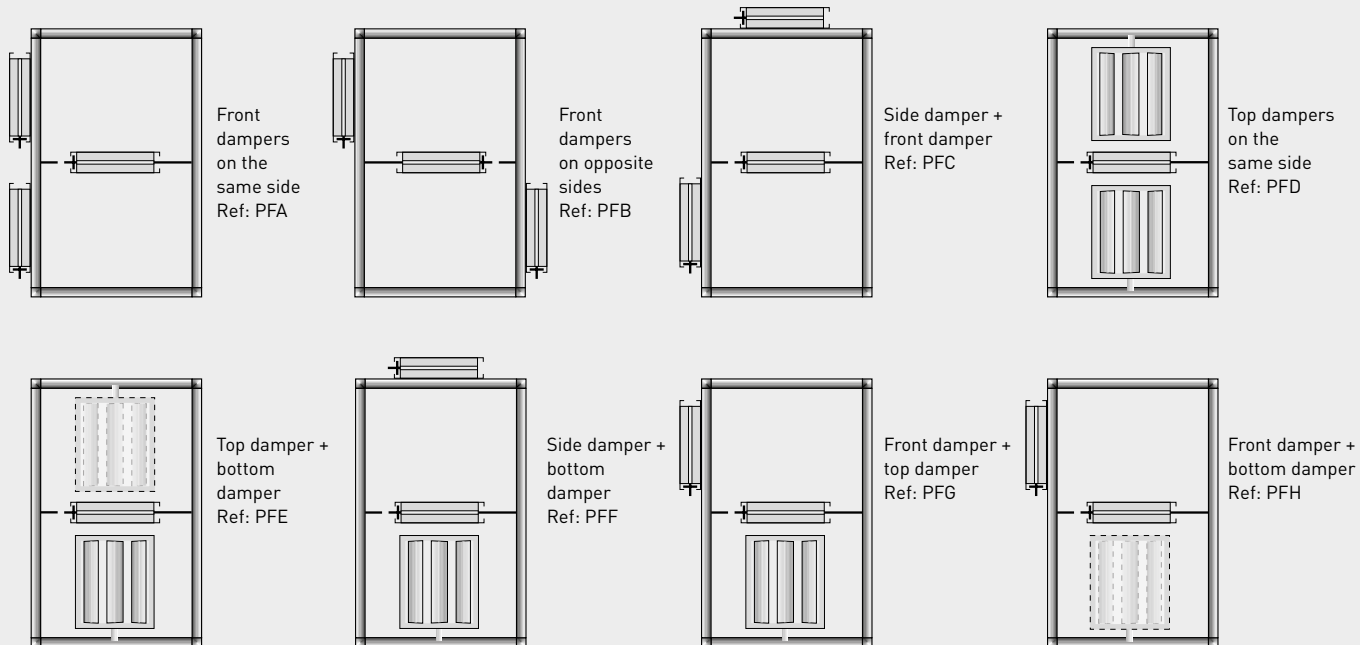

Model	PFA, PFB, PFC, PFD		Width (mm)
	Weight (kg)	Length (mm)	
UTBS-2	61	750	1572
UTBS-3	109	969	2272
UTBS-5	211	1455	3072
UTBS-8	264	1455	3872

Model	Interior (l x h)	Side (l x h)	Front (l x h)	Top (l x h)
UTBS-2	400 x 210	400 x 210	400 x 210	400 x 210
UTBS-3	800 x 210	800 x 210	800 x 210	800 x 210
UTBS-5	1200 x 210	1200 x 210	1200 x 210	1200 x 210
UTBS-8	1100 x 310	1100 x 310	1600 x 310	1600 x 310

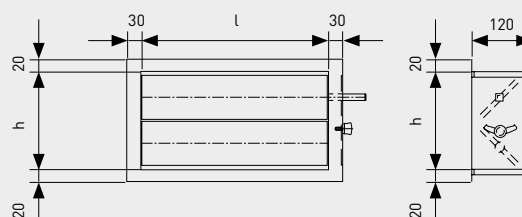

l= Damper width  
h= Damper height

#### Example

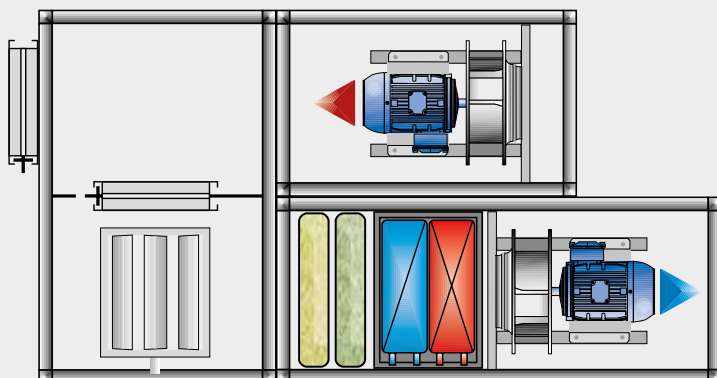

**OPTIONAL MODULES**

**IN-LINE HEAT RECOVERY BOX (REL)**

Heat recovery module to connect aligned units. Filters and dampers may be added to the air inlets and outlets. Aluminium cross-flow type plate exchanger. Condensates collecting tray. Dampers may be added to the module's inlets and outlets. The dampers can be activated manually or with a servomotor. With pressure outlets at both sides of the filters.

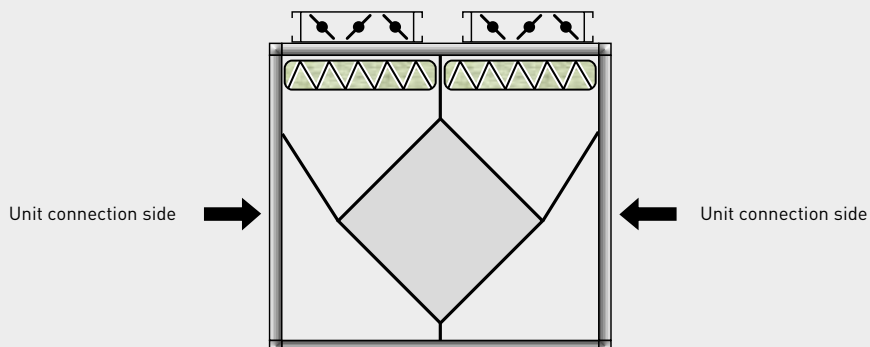

Model	Length (mm)	Weight (kg)	Pre-filters		Dampers (L x h)
			Units	Weight (kg)	
UTBS-2	969	49	1	2	650 x 310
UTBS-3	969	66	1	4	1000 x 310
UTBS-5	969	84	2	6	1400 x 310
UTBS-8	1205	135	2	8	1800 x 410

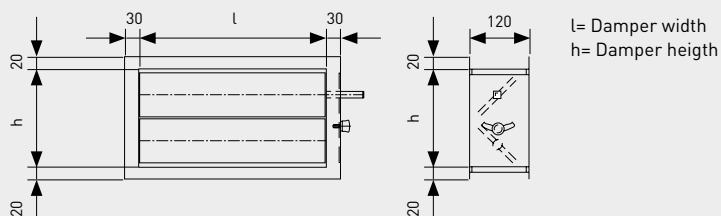

**Example**

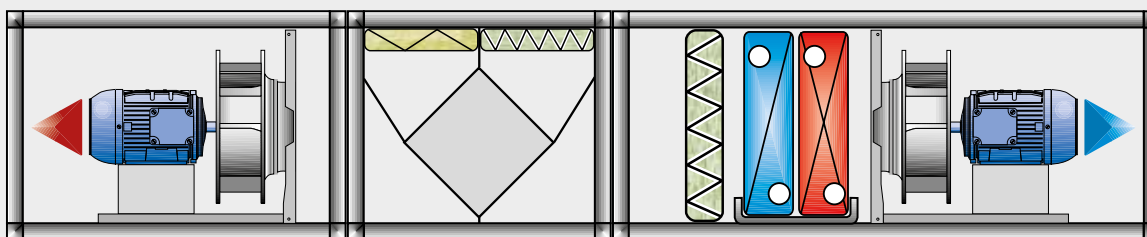

**OPTIONAL MODULES**

**STACKED HEAT RECOVERY BOX (RED)**

Heat recovery module to connect units in high ceilings. Filters and dampers can be added to air inlets and outlets. Aluminium cross-flow type plate exchanger. Condensates collecting tray. Dampers may be added to the module's inlets and outlets. The dampers can be activated manually or with a servomotor. With pressure outlets at both sides of the filters.

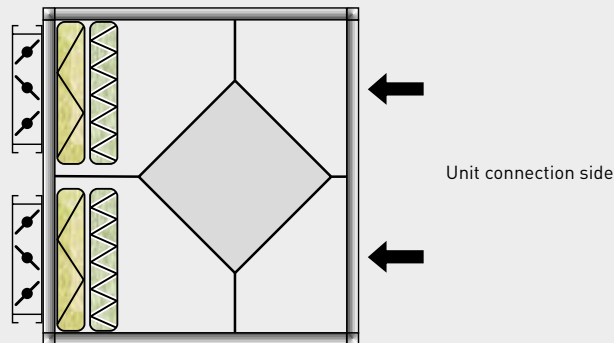

Model	Length (mm)	Height (mm)	Weight (kg)	Pre-filters		High-efficiency filter		Dampers (l x h)
				Units	Weight (kg)	Units	Weight (kg)	
UTBS-2	969	720	67	1	2	1	3	400 x 210
UTBS-3	969	820	93	1	4	1	5	800 x 210
UTBS-5	969	820	115	2	6	2	7	1200 x 210
UTBS-8	1205	1000	197	2	8	2	9	1800 x 310

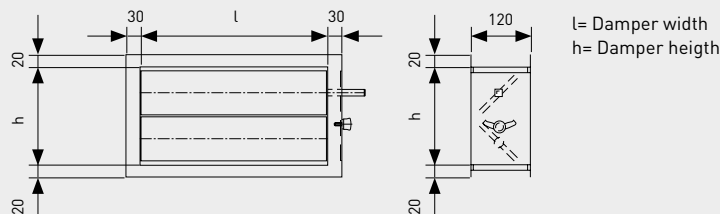

**Example**

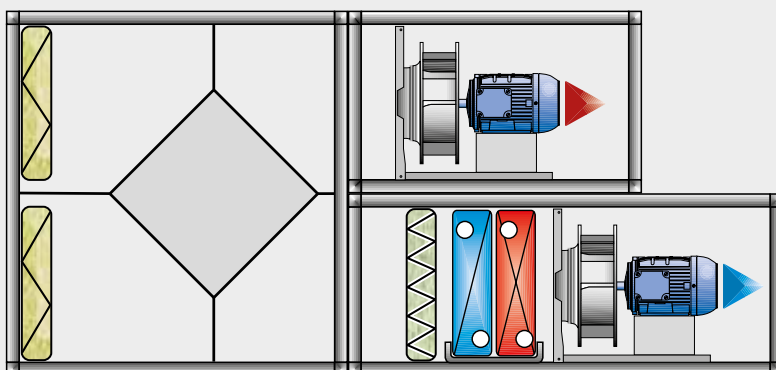



OPTIONAL MODULES

**SIDE-BY-SIDE HEAT RECOVERY BOX (REP)**

Heat recovery module to connect units in parallel. Filters and dampers can be added to air inlets and outlets. Aluminium cross-flow type plate exchanger. Condensates collecting tray. Dampers may be added to the module's inlets and outlets. The dampers can be activated manually or with a servomotor. With pressure outlets at both sides of the filters.

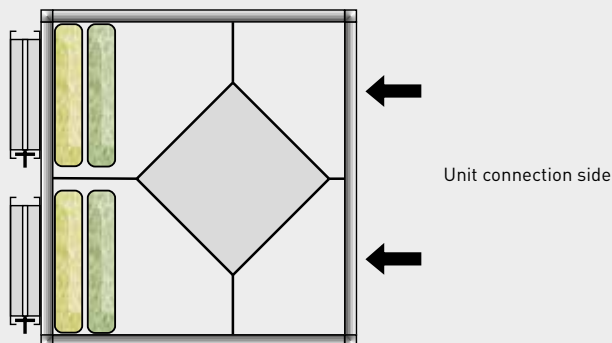

Model	Length (mm)	Width (mm)	Weight (kg)	Pre-filters		High-efficiency filter		Dampers (L x h)
				Units	Weight (kg)	Units	Weight (kg)	
UTBS-2	1205	1572	118	1	2	1	3	650 x 210
UTBS-3	1455	2272	188	1	4	1	5	1000 x 310

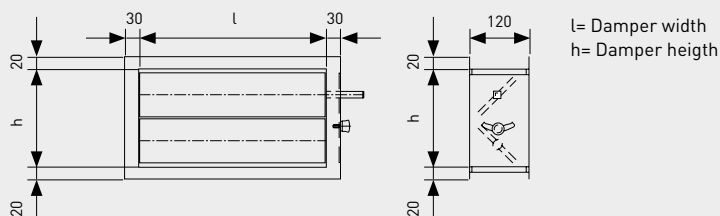

**Example**

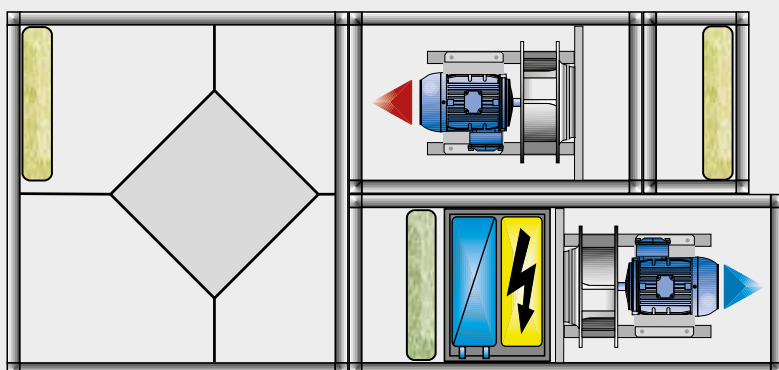

\* Top view

### Efficiency curves

Efficiency calculated during air supply, with balanced flows and under the following conditions:

Exterior: -5°C, 80% H.R.

Interior: 20°C, 50% H.R.

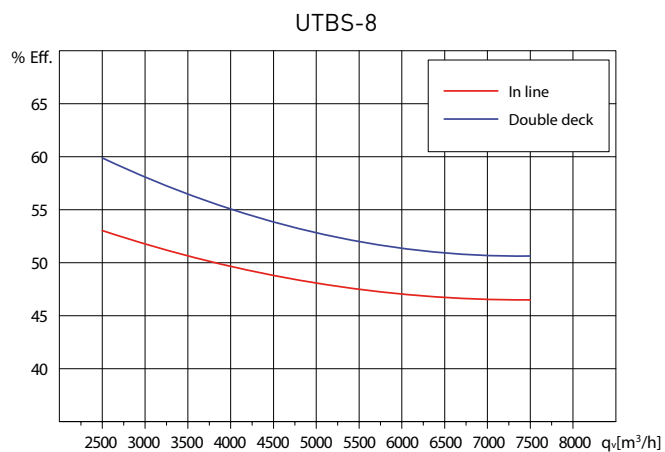
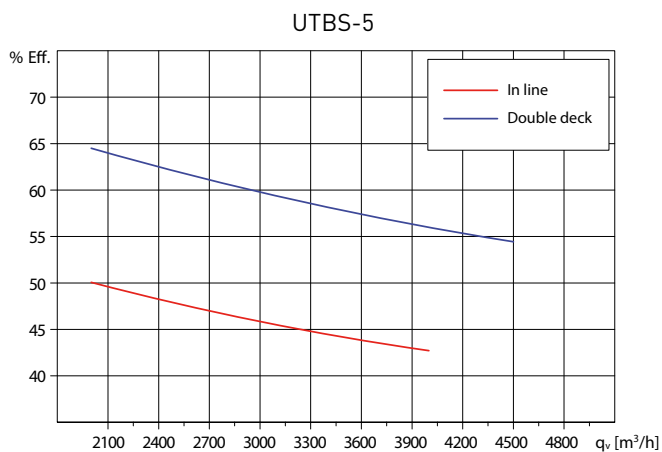
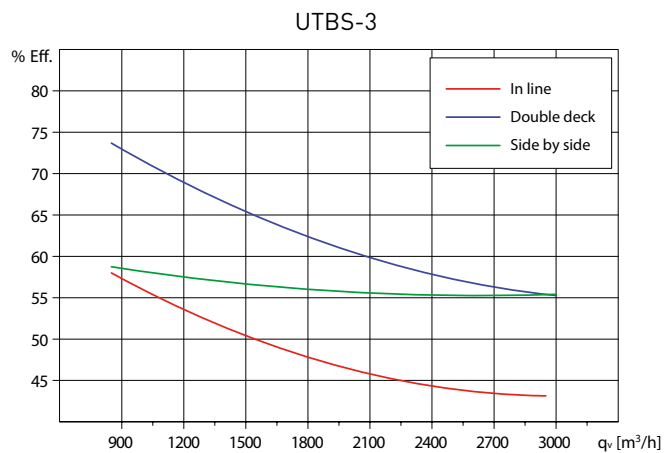
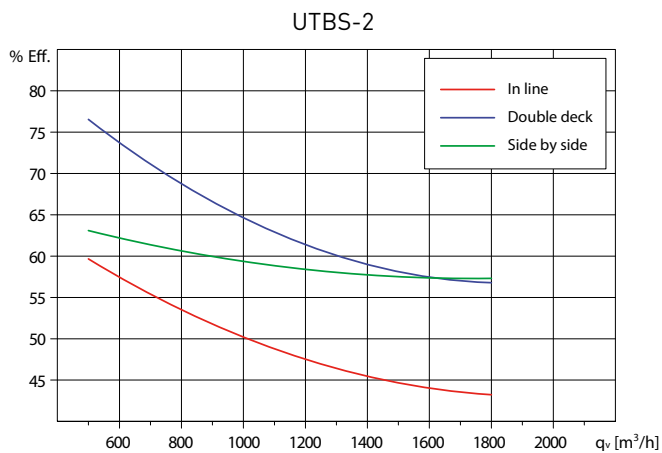

REFERENCE

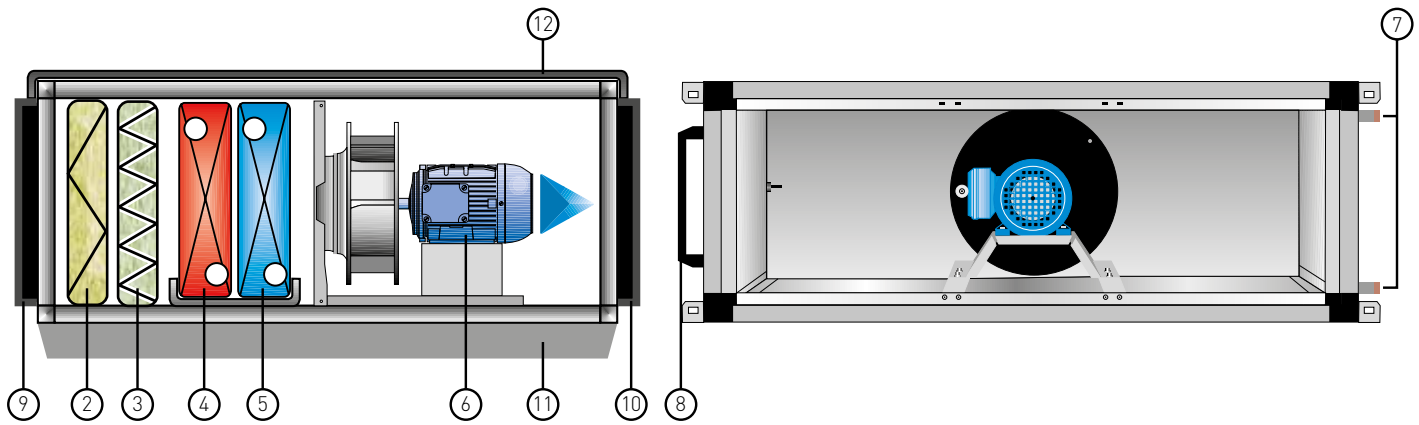

MAIN BOX

<b>UTBS-5</b>	<b>G</b>	<b>F7</b>	<b>E</b>	<b>C4</b>	<b>0,75</b>	<b>kW</b>	<b>R</b>	<b>L</b>	<b>IC</b>	<b>OC</b>	<b>B</b>	<b>OR</b>	
<p><b>1. SIZE</b></p> <p>UTBS-2 UTBS-3 UTBS-5 UTBS-8</p>											<p><b>12. ROOF</b></p> <p>OR: With roof Ø: Without roof</p>		
<p><b>2. PRE-FILTERS</b></p> <p>G: Pre-filter G4 M: Pre-filter F5 F: Pre-filter F6 R: Pre-filter F7 Ø: Without pre-filter</p>											<p><b>11. BASE</b></p> <p>B: With base Ø: Without base</p>		
<p><b>3. FILTERS</b></p> <p>F6: Filter F6 F7: Filter F7 F8: Filter F8 F9: Filter F9 Ø: Without filter</p>											<p><b>10. OUTLET FLANGE</b></p> <p>OC: With outlet flange Ø: Without outlet flange</p>		
<p><b>4. FIRST COIL</b></p> <p>HC2: 2-row hot water coil HC4: 4-row hot water coil HC6: 6-row hot water coil CC4: 4-row cold water coil CC6: 6-row cold water coil EH: Electric coils Ø: Without coil</p>											<p><b>9. INLET FLANGE</b></p> <p>IC: With inlet flange Ø: Without inlet flange</p>		
<p><b>5. SECOND COIL</b></p> <p>HC2: 2-row hot water coil HC4: 4-row hot water coil CC4: 4-row cold water coil CC6: 6-row cold water coil EH: Electric heaters Ø: Without coil</p>											<p><b>8. ACCESS DOORS SIDE</b></p> <p>R: Access doors to the right L: Access doors to the left</p>		
												<p><b>7. CONNECTIONS SIDE</b></p> <p>R: Right-hand-side connections L: Left-hand-side connections</p>	
												<p><b>6. MOTOR POWER</b></p> <p>0,18: For UTBS-2 (1 fan) 0,25: For UTBS-2 and UTBS-3 (1 fan) and for UTBS-5 and UTBS-8 (2 fans) 0,37: For UTBS-2 (1 fan) 0,55: For UTBS-2 and UTBS-3 (1 fan) and for UTBS-2 and UTBS-5 (2 fans) 0,75: For UTBS-2 and UTBS-3 (1 fan) and for UTBS-2 and UTBS-5 (2 fans) 1,1: For UTBS-3 (1 fan) and for UTBS-5 and UTBS-8 (2 fans) 1,5: For UTBS-2 and UTBS-3 (1 fan) and for UTBS-2 and UTBS-5 (2 fans) 2,2: For UTBS-2 and UTBS-3 (1 fan) and for UTBS-2 and UTBS-5 (2 fans)</p>	

REFERENCE –MODULES

PLENUM

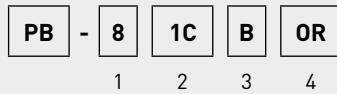

- |  |  |
|--|--|
| <p><b>1. SIZE</b><br/>2, 3, 5 and 8</p> <p><b>2. FLANGES</b><br/>1C: One flange<br/>2C: Two flanges<br/>Ø: Without flanges</p> | <p><b>3. BASE</b><br/>B: With base<br/>Ø: Without base</p> <p><b>4. ROOF</b><br/>OR: With roof<br/>Ø: Without roof</p> |
|--|--|

FILTER BOX



- |   |   |
|---|---|
| <p><b>1. SIZE</b><br/>2, 3, 5 and 8</p> <p><b>2. PRE-FILTER</b><br/>G: Filter G4<br/>M: Filter F5<br/>F: Filter F6<br/>Ø: Without flanges</p> <p><b>3. FILTER</b><br/>F6: Filter F6<br/>F7: Filter F7<br/>F8: Filter F8<br/>F9: Filter F9<br/>Ø: Without base</p> | <p><b>4. ACCESS DOOR</b><br/>R: Right<br/>L: Left</p> <p><b>5. FLANGES</b><br/>1C: One flange<br/>2C: Two flanges<br/>Ø: Without flanges</p> <p><b>6. BASE</b><br/>B: With base<br/>Ø: Without base</p> <p><b>7. ROOF</b><br/>OR: With roof<br/>Ø: Without roof</p> |
|---|---|

ELECTRIC HEATER

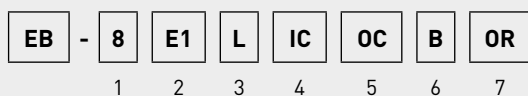

- |   |  |
|---|--|
| <p><b>1. SIZE</b><br/>2, 3, 5 and 8</p> <p><b>2. COIL STAGES</b><br/>E1: 1 stage<br/>E2: 2 stages<br/>E3: 3 stages</p> <p><b>3. CONNECTIONS</b><br/>R: Right<br/>L: Left</p> <p><b>4. INLET FLANGE</b><br/>IC: With flange<br/>Ø: Without flanges</p> | <p><b>5. OUTLET FLANGE</b><br/>IC: With flange<br/>Ø: Without flanges</p> <p><b>6. BASE</b><br/>B: With base<br/>Ø: Without base</p> <p><b>7. ROOF</b><br/>OR: With roof<br/>Ø: Without roof</p> |
|---|--|

WATER COIL BOX

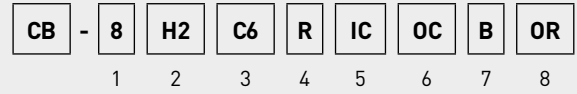

- |   |  |
|---|--|
| <p><b>1. SIZE</b><br/>2, 3, 5 and 8</p> <p><b>2. COIL 1</b><br/>H2: 2-row hot water coil<br/>H4: 4-row hot water coil<br/>C4: 4-row cold water coil<br/>C6: 6-row cold water coil<br/>E1: 1-row electric heater (UTBS-2)<br/>E2: 2-row electric heater (UTBS-3 and UTBS-5)<br/>E3: 3-row electric heater (UTBS-8)<br/>Ø: Without coil</p> <p><b>3. COIL 2</b><br/>H2: 2-row hot water coil<br/>H4: 4-row hot water coil<br/>C4: 4-row cold water coil<br/>C6: 6-row cold water coil<br/>E1: 1-row electric heater (UTBS-2)<br/>E2: 2-row electric heater (UTBS-3 and UTBS-5)<br/>E3: 3-row electric heater (UTBS-8)<br/>Ø: Without coil</p> | <p><b>CONNECTIONS</b><br/>R: Right<br/>L: Left</p> <p><b>5. INLET FLANGE</b><br/>IC: With flange<br/>Ø: Without flanges</p> <p><b>6. OUTLET FLANGE</b><br/>IC: With flange<br/>Ø: Without flanges</p> <p><b>7. BASE</b><br/>B: With base<br/>Ø: Without base</p> <p><b>8. ROOF</b><br/>OR: With roof<br/>Ø: Without roof</p> |
|---|--|

1 DAMPER BOX

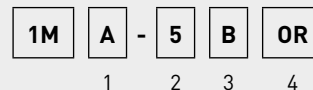

- |   |  |
|---|--|
| <p><b>1. CONFIGURATION</b><br/>Please refer to the configuration page</p> <p><b>2. SIZE</b><br/>2, 3, 5 and 8</p> | <p><b>3. BASE</b><br/>B: With base<br/>Ø: Without base</p> <p><b>4. ROOF</b><br/>OR: With roof<br/>Ø: Without roof</p> |
|---|--|

REFERENCE – MODULES

2 WAYS MIXING BOX

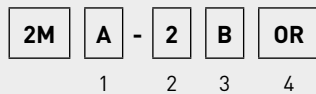

- |   |  |
|---|--|
| <p><b>1. CONFIGURATION</b><br/>Please refer to the configuration page</p> <p><b>2. SIZE</b><br/>2, 3, 5 and 8</p> | <p><b>3. BASE</b><br/>B: With base<br/>Ø: Without base</p> <p><b>4. ROOF</b><br/>OR: With roof<br/>Ø: Without roof</p> |
|---|--|

SIDE-BY-SIDE FREE-COOLING

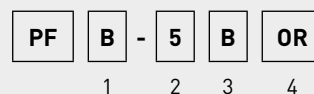

- |   |  |
|---|--|
| <p><b>1. CONFIGURATION</b><br/>Please refer to the configuration page</p> <p><b>2. SIZE</b><br/>2, 3, 5 and 8</p> | <p><b>3. BASE</b><br/>B: With base<br/>Ø: Without base</p> <p><b>4. ROOF</b><br/>OR: With roof<br/>Ø: Without roof</p> |
|---|--|

IN-LINE FREE-COOLING

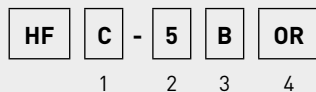

- |   |  |
|---|--|
| <p><b>1. CONFIGURATION</b><br/>Please refer to the configuration page</p> <p><b>2. SIZE</b><br/>2, 3, 5 and 8</p> | <p><b>3. BASE</b><br/>B: With base<br/>Ø: Without base</p> <p><b>4. ROOF</b><br/>OR: With roof<br/>Ø: Without roof</p> |
|---|--|

SILENCER

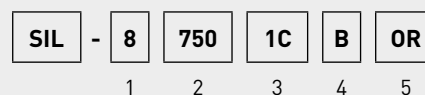

- |  |  |
|--|--|
| <p><b>1. SIZE</b><br/>2, 3, 5 and 8</p> <p><b>2. MUFFLER LENGTH</b><br/>750<br/>1100</p> <p><b>3. FLANGES</b><br/>1C: One flange<br/>2C: Two flanges Without flanges</p> | <p><b>4. BASE</b><br/>B: With base<br/>Ø: Without base</p> <p><b>5. ROOF</b><br/>OR: With roof<br/>Ø: Without roof</p> |
|--|--|

STACKED FREE-COOLING BOX

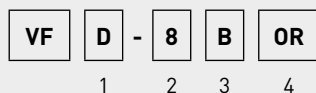

- |   |  |
|---|--|
| <p><b>1. CONFIGURATION</b><br/>Please refer to the configuration page</p> <p><b>2. SIZE</b><br/>2, 3, 5 and 8</p> | <p><b>3. BASE</b><br/>B: With base<br/>Ø: Without base</p> <p><b>4. ROOF</b><br/>OR: With roof<br/>Ø: Without roof</p> |
|---|--|

REFERENCE –MODULES

SIDE-BY-SIDE HEAT RECOVERY BOX

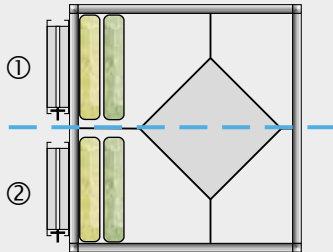
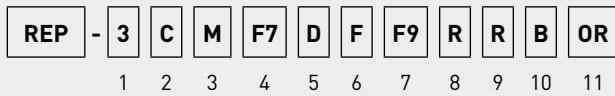

- 1. SIZE**  
2, 3 and 5
- 2. SIDE 1 DAMPER/ FLANGES**  
C: With flange  
D: With damper  
N: Without damper
- 3. SIDE 1 PRE-FILTER**  
G: Filter G4  
M: Filter F5  
F: Filter F6  
∅: Without pre-filter
- 4. SIDE 1 FILTER**  
F6: Filter F6  
F7: Filter F7  
F8: Filter F8  
F9: Filter F9  
∅: Without filter
- 5. SIDE 2 DAMPER / FLANGES**  
C: With flange  
D: With damper  
N: Without damper
- 6. SIDE 2 PRE-FILTER**  
G: Filter G4  
M: Filter F5  
F: Filter F6  
∅: Without pre-filter
- 7. SIDE 2 FILTER**  
F6: Filter F6  
F7: Filter F7  
F8: Filter F8  
F9: Filter F9  
∅: Without filter
- 8. DRAINROW SIDE**  
R: Right  
L: Left
- 9. ACCESS DOORS SIDE**  
R: Right  
L: Left
- 10. BASE**  
B: With base  
∅: Without base
- 11. ROOF**  
OR: With roof  
∅: Without roof

STACKED HEAT RECOVERY BOX

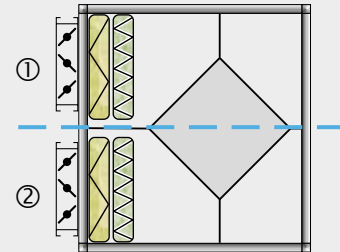
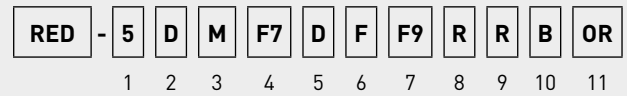

- 1. SIZE**  
2, 3, 5 and 8
- 2. SIDE 1 DAMPER/ FLANGES**  
C: With flange  
D: With damper  
N: Without damper
- 3. SIDE 1 PRE-FILTER**  
G: Filter G4  
M: Filter F5  
F: Filter F6  
∅: Without pre-filter
- 4. SIDE 1 FILTER**  
F6: Filter F6  
F7: Filter F7  
F8: Filter F8  
F9: Filter F9  
∅: Without filter
- 5. SIDE 2 DAMPER / FLANGES**  
C: With flange  
D: With damper  
N: Without damper
- 6. SIDE 2 PRE-FILTER**  
G: Filter G4  
M: Filter F5  
F: Filter F6  
∅: Without pre-filter
- 7. SIDE 2 FILTER**  
F6: Filter F6  
F7: Filter F7  
F8: Filter F8  
F9: Filter F9  
∅: Without filter
- 8. DRAINROW SIDE**  
R: Right  
L: Left
- 9. ACCESS DOORS SIDE**  
R: Right  
L: Left
- 10. BASE**  
B: With base  
∅: Without base
- 11. ROOF**  
OR: With roof  
∅: Without roof

REFERENCE –MODULES

IN-LINE HEAT RECOVERY BOX

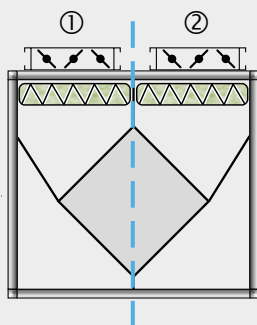

- |   |  |
|---|--|
| <p><b>1. SIZE</b><br/>2, 3, 5 and 8</p> <p><b>2. SIDE 1 DAMPER/ FLANGES</b><br/>C: With flange<br/>D: With damper<br/>N: Without damper</p> <p><b>3. SIDE 1 PRE-FILTER</b><br/>G: Filter G4<br/>M: Filter F5<br/>F: Filter F6<br/>F7: Filter F7<br/>F8: Filter F8<br/>F9: Filter F9<br/>∅: Without filter</p> <p><b>4. SIDE 2 DAMPER/ FLANGES</b><br/>C: With flange<br/>D: With damper<br/>N: Without damper</p> | <p><b>5. SIDE 2 FILTER</b><br/>G: Filter G4<br/>M: Filter F5<br/>F: Filter F6<br/>F7: Filter F7<br/>F8: Filter F8<br/>F9: Filter F9<br/>∅: Without filter</p> <p><b>6. DRAINROW SIDE</b><br/>R: Right<br/>L: Left</p> <p><b>7. ACCESS DOORS SIDE</b><br/>R: Right<br/>L: Left</p> <p><b>8. BASE</b><br/>B: With base<br/>∅: Without base</p> <p><b>9. ROOF</b><br/>OR: With roof<br/>∅: Without roof</p> |
|---|--|

### MOUNTING ACCESSORIES

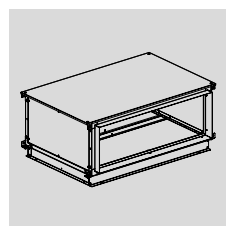

**Rain cowl and base**

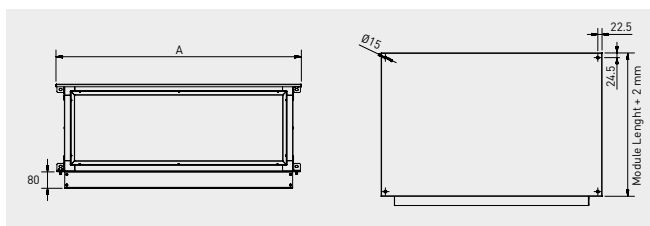

Model	A (mm)
UTBS-2	830
UTBS-3	1180
UTBS-5	1580
UTB S-8	1980

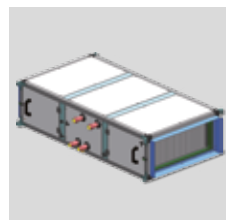

**Connection flange**

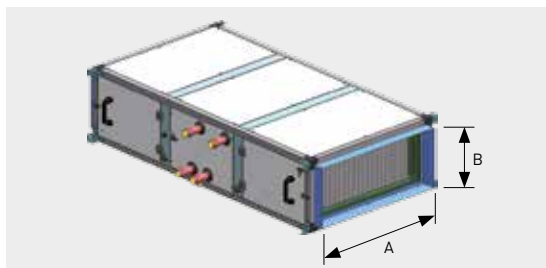

Model	A (mm)	B (mm)
UTBS-2	690	300
UTBS-3	1040	350
UTBS-5	1440	350
UTB S-8	1840	440



**AFR spare filter**

G4	F5	F6	F7	F8	F9	Units	Dimensions
AFR UTBS-2 G4	AFR UTBS-2 F5	AFR UTBS-2 F6	AFR UTBS-2 F7	AFR UTBS-2 F8	AFR UTBS-2 F9	1	645 x 250 x 48
AFR UTBS-3 G4	AFR UTBS-3 F5	AFR UTBS-3 F6	AFR UTBS-3 F7	AFR UTBS-3 F8	AFR UTBS-3 F9	1	995 x 300 x 48
AFR UTBS-5 G4	AFR UTBS-5 F5	AFR UTBS-5 F6	AFR UTBS-5 F7	AFR UTBS-5 F8	AFR UTBS-5 F9	2	695 x 300 x 48
AFR UTBS-8 G4	AFR UTBS-8 F5	AFR UTBS-8 F6	AFR UTBS-8 F7	AFR UTBS-8 F8	AFR UTBS-8 F9	2	895 x 380 x 48



**ID Isolating damper**

Accessory including one regulating damper that can be mounted in the inlet or outlet side of main box.

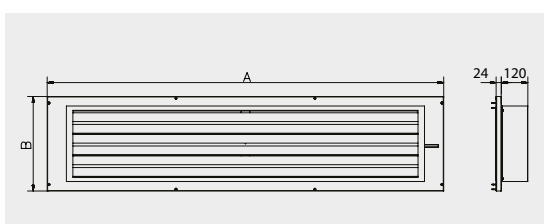

Model	A (mm)	B (mm)
UTBS 2	688	298
UTBS 3	1038	348
UTBS 5	1438	348
UTBS 8	1838	438



**JF Flexible connections**

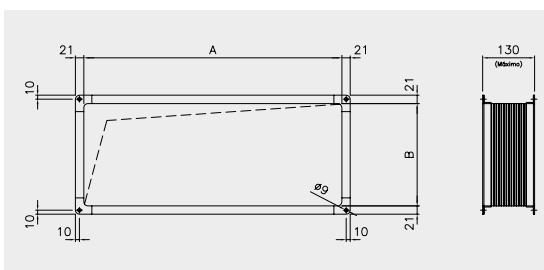

Flexible connections		
A (mm)	B (mm)	Weight (kg)
646	256	3
996	306	4
1396	306	5
1796	396	6
400	210	2
650	210	3
800	210	3,5
1200	210	4
450	310	2
650	310	3
750	310	3,5
1000	310	4
1100	310	4,5
1400	310	5
1600	310	5,5
900	410	4,5
1800	410	6



**MOUNTING ACCESSORIES**

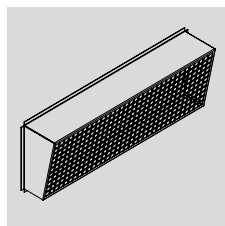

**Side and front damper covers**

- VF Cover for front damper
- VL Cover for side damper
- VLF Cover for side-by-side free-cooling damper
- VRP Cover for side-by-side heat recovery damper

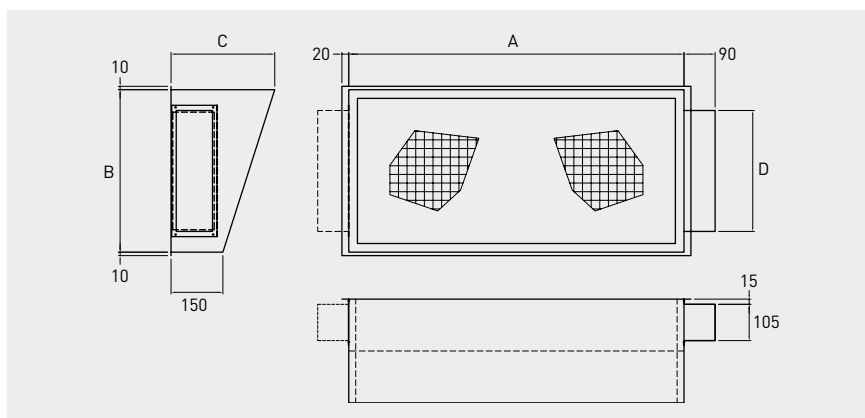

Model	Vent size		Cover				Weight (kg)
	Length	Width	A	B	C	D	
VF UTBS-2	400	210	470	270	250	200	2
VL UTBS-2							
VLF UTBS-2							
VRP UTBS-2	650	210	720	270	250	200	3
VF UTBS-3	800	210	870	270	250	200	3
VLF UTBS-3							
VF UTBS-5	1200	210	1270	270	250	200	4
VLF UTBS-5							
VL UTBS-3	450	310	520	370	275	250	5
VL UTBS-5	750	310	820	370	275	250	6
VRP UTBS-3	1000	310	1070	370	275	250	7
VLF UTBS-8	1100	310	1170	370	275	250	8
VRP UTBS-8	1400	310	1470	370	275	250	9
VF UTBS-8	1600	310	1670	370	275	250	10
VL UTBS	900	410	970	470	300	350	8
VRP UTBS-8	1800	410	1870	470	300	350	12

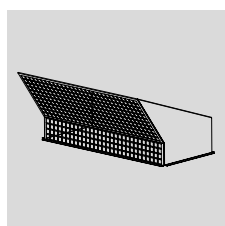

**Roof damper covers**

- VS Cover for top damper
- VRL Cover for in-line heat recovery damper

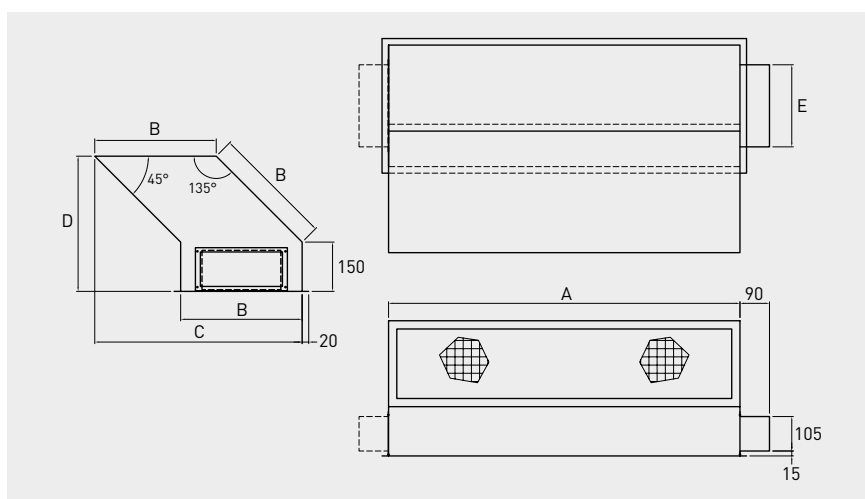

Model	Vent size		Cover					Weight (kg)
	Length	Width	A	B	C	D	E	
VS UTBS-2	400	210	470	270	461	341	200	7
VS UTBS-3	800	210	870	270	461	341	200	12
VS UTBS-5	1200	210	1270	270	461	341	200	18
VRL UTBS-2	650	310	720	370	632	412	250	12
VRL UTBS-3	1000	310	1070	370	632	412	250	16
VRL UTBS-5	1400	310	1470	370	632	412	250	21
VS UTBS-8	1600	310	1670	370	632	412	250	22
VRL UTBS-8	1800	410	1870	470	802	482	350	31

**ELECTRICAL ACCESSORIES**



**VFTM IP21**  
**Adjustable frequency drives**  
For three phase motors from 0.37 to 15 kW.  
Din Rail mounting (IP21).  
Voltage supplies: single phase 230V-50/60Hz (VFTM MONO), three phase 400V-50/60Hz (VFTM TRI).



**VFTM IP54**  
**Adjustable frequency drives**  
For three phase motors from 0.37 to 15 kW.  
Din Rail mounting (IP54).  
Voltage supplies: single phase 230V-50/60Hz (VFTM MONO), three phase 400V-50/60Hz (VFTM TRI).



**PRESOSTATO DPS 2-30 / DPS 10-100**  
**Differential pressure switch**  
Differential pressure switch to control the fan running and the filter clogging up.  
Protection class: IP54.  
Can be used outside.  
It identifies pressure differences of 2 to 30 mmWG.



**SM**  
**Servomotor**  
Servomotors for damper activation.

**SM-230 T/N**  
Servomotor with on/off output 230V supply.

**SM-24/PRO**  
Servomotor with proportional output 24V supply.



**TDP-D**  
**Pressure sensor**  
They are used to control the pressure in ventilation systems under constant pressure or constant flow.  
They can read a difference in pressure between two points, transforming it into an electric signal for the different types of control.

**SM-24 T/N**  
Servomotor with on/off output 24V supply.