



In-line mixed-flow fans, low profile, for circular ducts and manufactured with 85% recycled plastics. The impeller and silent-block are kept in reinforced virgin plastics to ensure performance. The range comprises seven diameters and covers a flow range from 190 to 1780 m³/h.

The unique design of the support bracket allows the motor and impeller assembly to be fitted or removed without dismantling the adjacent ducting. Optimised design of the impeller, guide vane and outlet diffuser, to increase performance and lower the sound level. Airtight construction with double-injection sealing between the main body and the support bracket to avoid air leaks. Rubber gaskets on the flanges to improve airtightness with the ducts. Silent-block between the motor and the guide vane to reduce the motor's vibrations and lower the sound level of the installation, even in terms of speed regulation.

Motor

- Brushless EC motor:
 - 230V±10% 50/60Hz, Class B, IP44.
 - Speed adjustable 100% via potentiometer located in the terminal box or via external control REB-ECOWATT type. Analogue input remote control with 0-10V external signal.
 - Ball bearings and thermal protection with manual reset.
 - Working temperature: -20/40°C.

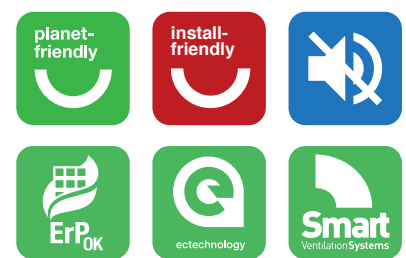

S&P certifies that the TD-EVO PF ECOWATT shown herein are licensed to bear the AMCA Seal. The ratings shown are based on tests and procedures performed in accordance with AMCA Publication 211 and AMCA Publication 311 and comply with the requirements of the AMCA Certified Ratings Program

The TD EVO fans offer the ideal in-line duct fan solution for a wide range of general residential or commercial ventilation application into.



VERY LOW PROFILE

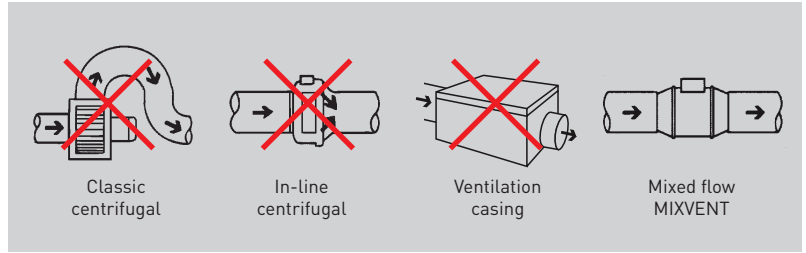

The low profile of the TD-EVO fans makes them the most effective solution for installations where the space of installation is limited such as false ceilings.

EASY INSTALLATION AND MAINTENANCE



Articulated fixing clamps with the possibility of mounting them from one side or the other, with conical profile for better airtightness with the main fan body and fixing by screws.



To reverse the direction of the airflow simply return the main fan body without having to disassemble the support foot. The rotation of the main fan body also allows to position the terminal box to allow the best accessibility.

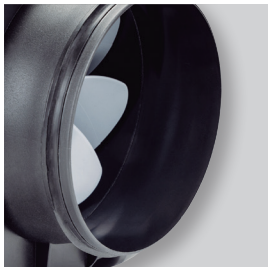

Circular duct connection with integrated rubber seals to allow airtight installation with duct system.



Pre-assembly of the main fan body on the support foot to ease handling / orientation of the product leaving the hands free to the installer.



Large size terminal box, closed by a single screw.

HIGH PERFORMANCES



Silent-block
 Silent-block between the motor and the support to reduce motor vibrations and lower the sound level of the fan.

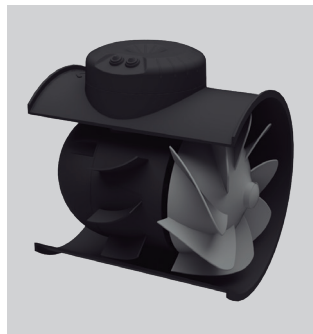

Guide vane - outlet fairing
 Optimised guide vane with outlet fairing to increase performance, efficiency and lower sound levels.

EASY MAINTENANCE



The unique design of the support bracket allows the motor and impeller assembly to be fitted or removed.

TECHNICAL CHARACTERISTICS SPEED

Before installation check that the product electrical characteristics listed on the data plate label (voltage, power, frequency, etc.) match those of the intended electrical supply.

Model	Input tension regul. (V)	Speed (r.p.m.)	Maximum absorbed power (W)	Maximum absorbed current (A)	Maximum airflow (m³/h)	Sound pressure level* (dB(A))			Weight (Kg)
						Inlet	Radiated	Outlet	
TD EVO-100 PF ECOWATT	10	2250	9	0,10	190	32	18	31	1,7
	8	1940	7	0,10	170	28	14	28	
	6	1530	5	0,10	130	23	11	23	
	4	1120	3	0,10	90	16	10	16	
TD EVO-125 PF ECOWATT	10	2250	14	0,10	310	35	20	37	1,8
	8	1930	10	0,10	260	32	16	34	
	6	1520	6	0,10	210	27	11	28	
	4	1100	4	0,10	150	20	10	21	
TD EVO-150 PF ECOWATT	10	2650	38	0,30	560	44	30	45	2,1
	8	2240	24	0,20	480	40	26	41	
	6	1740	12	0,10	360	35	21	36	
	4	1250	6	0,10	260	27	14	28	
TD EVO-160 PF ECOWATT	10	2650	37	0,30	580	44	29	46	2,1
	8	2250	24	0,20	490	41	25	42	
	6	1760	13	0,10	370	35	20	37	
	4	1250	6	0,10	260	28	12	29	
TD EVO-200 PF ECOWATT	10	2630	75	0,60	850	46	30	48	3,4
	8	2250	50	0,40	740	43	27	45	
	6	1750	26	0,20	570	37	21	39	
	4	1260	12	0,10	400	30	14	32	
TD EVO-250 PF ECOWATT	10	2640	141	0,90	1380	49	36	50	5,0
	8	2270	94	0,60	1180	46	32	47	
	6	1770	49	0,40	910	40	27	41	
	4	1280	22	0,20	650	33	20	34	
TD EVO-315 PF ECOWATT	10	2640	225	1,50	1780	57	41	55	7,5
	8	2280	145	1,00	1520	54	38	52	
	6	1770	73	0,50	1170	48	32	46	
	4	1280	33	0,30	840	41	25	39	

* Sound pressure level measured at 3 m in free field condition, at the duty points 2, 5, 8 and 11 of the performance curves.

DIMENSIONS (mm)

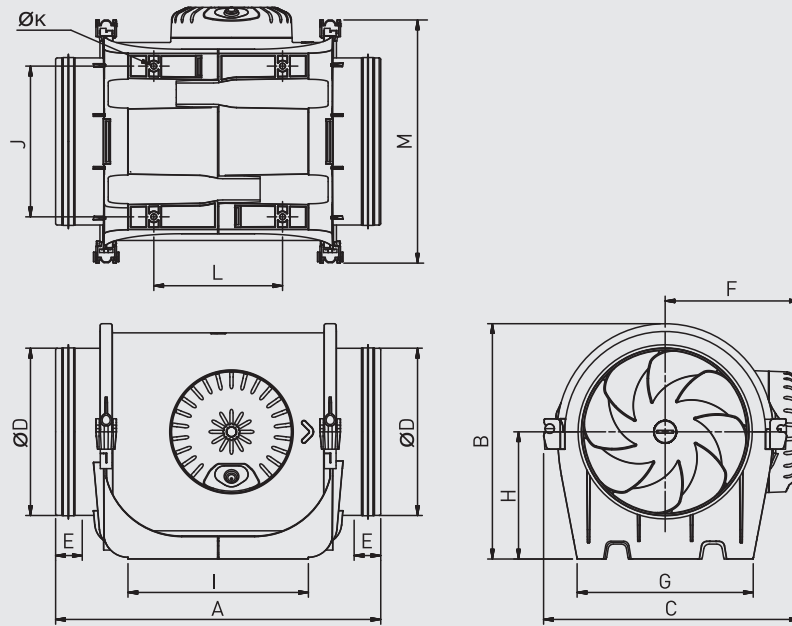

Model	A	B	C	ØD	E	F	G	H	I	J	ØK	L	M
TD EVO-100	302	181	201	97	28,5	107	133	100	168	100	4,5	89	189
TD EVO-125	302	191	221	122,5	28,5	117	132	100	172	104,5	4,5	91	209
TD EVO-150	326	221	240	147	25	126	165	120	170	142	5,5	121	229
TD EVO-160	306	221	240	157	25	126	165	120	170	142	5,5	121	229
TD EVO-200	346	238	263	197	28	137	190	124	211	161	5,5	161	253
TD EVO-250	390	289	306	247	40	159	230	155	231	194	7	182	295
TD EVO-315	485	353	371	312	40	192	278	188	317	242	7	206	358

PERFORMANCE CURVES

- q_v : Airflow in m^3/h .
- p_{sf} : Static pressure in Pa.
- Dry air at 20°C and 760 mmHg.
- Performance data in accordance with ISO 5801 and AMCA 210-99 Standards.
- SFP: Specific fan power in $W/m^3/s$ (blue curves).

Air performance certified by AMCA is for installation type D – Ducted inlet, Ducted outlet.
Performance ratings do not include the effects of appurtenances (accessories).

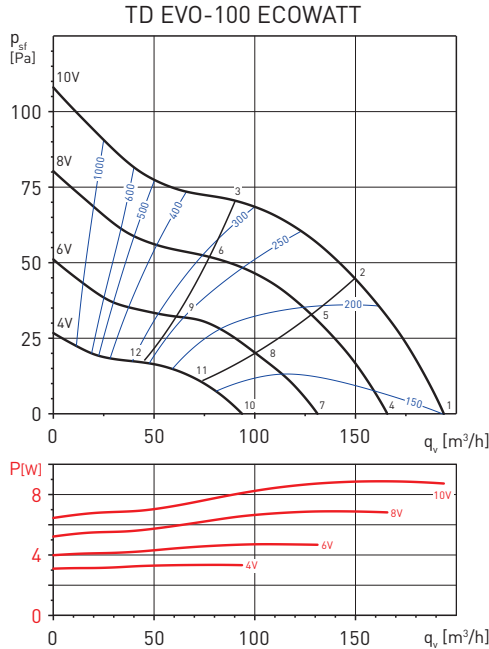

Sound data

Working point	1	2	3	4	5	6	7	8	9	10	11	12
LwiA	58	60	61	57	57	56	51	52	50	45	45	44

Sound performance certified by AMCA. Values shown are for inlet LwiA sound power levels for installation type D: ducted inlet, ducted outlet. Ratings include the effects of duct end correction.

The following sound data is a complementary data taken from S&P sound laboratory according ISO 13347-3, this data is not licensed by AMCA International.

Sound power spectrum (dB(A))

Working point	63	125	250	500	1000	2000	4000	8000	LwA
1 Inlet	22	25	41	46	48	45	39	29	52
1 Outlet	23	27	42	46	48	45	36	27	52
1 Break-Out	16	17	29	25	34	33	27	22	38
2 Inlet	21	26	40	47	48	44	39	29	52
2 Outlet	24	27	40	48	47	44	36	26	52
2 Break-Out	15	18	29	26	35	33	27	22	38
3 Inlet	26	34	41	46	47	41	37	29	51
3 Outlet	26	35	42	46	46	40	34	26	50
3 Break-Out	20	26	30	25	33	30	25	21	37
4 Inlet	19	22	38	43	45	41	35	26	49
4 Outlet	20	24	38	43	44	41	33	24	48
4 Break-Out	13	14	26	22	31	30	24	19	35
5 Inlet	18	23	37	44	45	40	36	26	49
5 Outlet	20	23	37	44	44	40	33	23	48
5 Break-Out	12	15	25	23	31	29	24	19	35
6 Inlet	22	30	38	43	43	38	34	25	48
6 Outlet	23	31	39	43	42	37	31	23	47
6 Break-Out	16	22	27	22	30	27	22	18	34
7 Inlet	14	16	33	38	39	36	30	21	43
7 Outlet	15	19	33	38	39	36	28	18	43
7 Break-Out	8	8	21	17	26	25	18	14	30
8 Inlet	13	17	32	39	40	35	31	21	44
8 Outlet	15	18	32	39	39	35	28	18	43
8 Break-Out	7	9	20	18	26	24	19	14	30
9 Inlet	17	25	33	38	38	33	28	20	42
9 Outlet	18	26	34	37	37	32	26	18	42
9 Break-Out	11	17	22	17	25	22	17	13	29
10 Inlet	7	10	26	31	33	29	23	14	37
10 Outlet	8	12	26	31	33	29	21	12	37
10 Break-Out	5	7	14	10	19	18	12	7	23
11 Inlet	6	11	25	32	33	29	24	14	37
11 Outlet	9	12	25	32	32	28	21	11	37
11 Break-Out	5	6	13	11	19	17	12	7	23
12 Inlet	10	18	26	31	32	26	22	13	36
12 Outlet	11	20	27	31	30	25	19	11	35
12 Break-Out	8	10	15	10	18	15	10	8	22

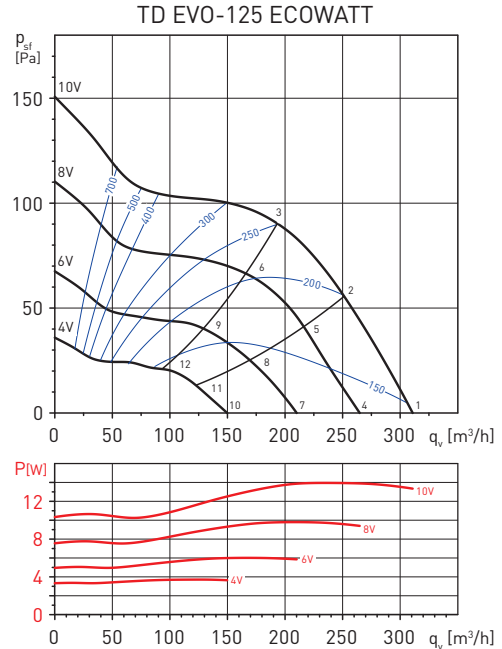

Sound data

Working point	1	2	3	4	5	6	7	8	9	10	11	12
LwiA	64	63	64	61	59	61	56	54	56	49	47	49

Sound performance certified by AMCA. Values shown are for inlet LwiA sound power levels for installation type D: ducted inlet, ducted outlet. Ratings include the effects of duct end correction.

The following sound data is a complementary data taken from S&P sound laboratory according ISO 13347-3, this data is not licensed by AMCA International.

Sound power spectrum (dB(A))

Working point	63	125	250	500	1000	2000	4000	8000	LwA
1 Inlet	24	26	47	52	52	51	46	36	57
1 Outlet	26	31	56	51	53	52	45	33	60
1 Break-Out	21	12	28	27	36	39	31	21	42
2 Inlet	24	24	47	50	51	49	44	35	56
2 Outlet	25	29	52	49	53	50	42	32	57
2 Break-Out	21	10	28	25	35	37	29	20	40
3 Inlet	28	33	51	53	51	48	44	35	57
3 Outlet	29	40	53	52	52	48	42	32	58
3 Break-Out	25	18	32	28	35	37	30	20	40
4 Inlet	20	23	43	49	49	48	42	33	54
4 Outlet	22	28	52	48	50	48	41	30	56
4 Break-Out	18	9	24	23	33	36	28	18	38
5 Inlet	20	21	43	47	48	46	40	32	52
5 Outlet	22	25	49	45	50	46	38	28	54
5 Break-Out	18	6	24	21	32	34	26	17	37
6 Inlet	24	29	47	50	48	45	41	32	54
6 Outlet	26	36	49	49	49	45	38	28	55
6 Break-Out	21	15	28	24	32	33	26	17	37
7 Inlet	15	18	38	43	44	42	37	27	49
7 Outlet	17	22	47	43	45	43	36	25	51
7 Break-Out	12	3	19	18	28	31	23	12	33
8 Inlet	15	15	38	41	43	41	35	26	47
8 Outlet	17	20	44	40	44	41	33	23	49
8 Break-Out	12	1	19	16	27	29	21	11	32
9 Inlet	19	24	42	44	42	40	36	26	49
9 Outlet	21	31	44	44	43	40	33	23	49
9 Break-Out	16	10	23	19	26	28	21	11	32
10 Inlet	8	11	31	36	37	35	30	20	42
10 Outlet	10	15	40	36	38	36	29	18	44
10 Break-Out	5	6	12	11	21	24	16	5	26
11 Inlet	8	8	31	34	36	34	28	19	40
11 Outlet	10	13	37	33	37	34	26	16	42
11 Break-Out	5	6	12	9	20	22	14	4	25
12 Inlet	12	17	35	37	35	33	29	19	42
12 Outlet	14	24	37	37	36	33	26	16	42
12 Break-Out	9	12	16	12	19	21	14	8	25

PERFORMANCE CURVES

- q_v : Airflow in m^3/h .
- p_{sf} : Static pressure in Pa.
- Dry air at 20°C and 760 mmHg.
- Performance data in accordance with ISO 5801 and AMCA 210-99 Standards.
- SFP: Specific fan power in $W/m^3/s$ (blue curves).

Air performance certified by AMCA is for installation type D – Ducted inlet, Ducted outlet.
Performance ratings do not include the effects of appurtenances (accessories).

TD EVO-150 ECOWATT

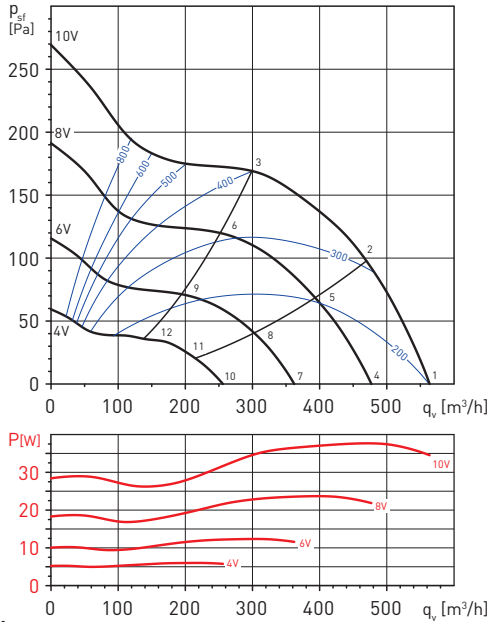

TD EVO-160 ECOWATT

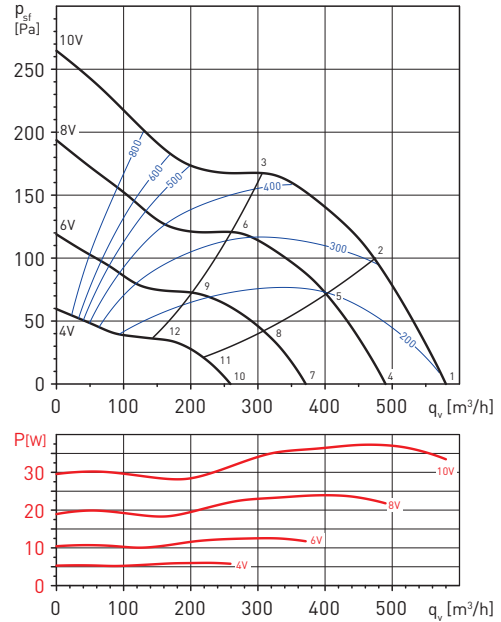

Sound data

Working point	1	2	3	4	5	6	7	8	9	10	11	12
LwA	71	69	70	67	65	67	62	60	61	54	53	54

Sound performance certified by AMCA. Values shown are for inlet LwA sound power levels for installation type D: ducted inlet, ducted outlet. Ratings include the effects of duct end correction.

The following sound data is a complementary data taken from S&P sound laboratory according ISO 13347-3, this data is not licensed by AMCA International.

Sound power spectrum (dB(A))

Working point	63	125	250	500	1000	2000	4000	8000	LwA
1 Inlet	28	33	51	60	63	58	46	36	66
1 Outlet	30	38	51	59	61	62	59	47	67
1 Break-Out	15	20	36	42	48	46	30	22	51
2 Inlet	27	30	51	56	59	60	54	43	64
2 Outlet	30	36	50	56	62	61	54	42	65
2 Break-Out	14	17	36	38	44	48	38	29	50
3 Inlet	34	43	60	60	58	58	52	41	65
3 Outlet	30	46	58	63	62	59	52	41	67
3 Break-Out	21	30	45	42	43	46	36	27	51
4 Inlet	24	29	47	56	59	54	42	32	62
4 Outlet	26	34	47	55	58	59	55	43	63
4 Break-Out	12	16	33	38	44	43	26	18	47
5 Inlet	23	26	47	52	55	56	50	39	60
5 Outlet	26	32	46	53	58	57	50	38	62
5 Break-Out	11	13	33	34	40	45	34	25	47
6 Inlet	30	39	56	56	54	54	48	37	62
6 Outlet	26	42	54	59	58	55	48	37	63
6 Break-Out	18	26	42	38	39	43	32	23	47
7 Inlet	19	24	42	51	54	49	37	27	57
7 Outlet	21	28	42	50	52	53	50	38	58
7 Break-Out	9	13	27	33	39	37	21	13	42
8 Inlet	18	21	42	47	50	51	45	34	55
8 Outlet	21	27	40	47	53	52	45	33	56
8 Break-Out	8	12	27	29	35	39	29	20	41
9 Inlet	25	34	51	51	49	49	43	32	56
9 Outlet	21	37	49	54	53	49	43	31	58
9 Break-Out	12	21	36	33	34	37	27	18	42
10 Inlet	12	17	35	44	47	42	30	20	49
10 Outlet	13	21	35	43	45	46	42	30	50
10 Break-Out	12	18	20	26	32	30	14	5	35
11 Inlet	11	14	35	40	43	44	38	27	48
11 Outlet	14	20	33	40	45	44	38	26	49
11 Break-Out	5	9	20	22	28	32	22	13	34
12 Inlet	18	27	44	44	42	42	36	25	49
12 Outlet	14	29	41	47	45	42	35	24	51
12 Break-Out	5	14	29	26	27	30	20	11	34

Sound data

Working point	1	2	3	4	5	6	7	8	9	10	11	12
LwA	72	70	70	68	66	67	63	61	61	55	53	54

Sound performance certified by AMCA. Values shown are for inlet LwA sound power levels for installation type D: ducted inlet, ducted outlet. Ratings include the effects of duct end correction.

The following sound data is a complementary data taken from S&P sound laboratory according ISO 13347-3, this data is not licensed by AMCA International.

Sound power spectrum (dB(A))

Working point	63	125	250	500	1000	2000	4000	8000	LwA
1 Inlet	31	35	52	58	61	63	59	47	67
1 Outlet	29	39	52	60	62	63	60	47	67
1 Break-Out	19	22	34	33	45	49	40	33	51
2 Inlet	30	33	51	55	60	61	55	43	65
2 Outlet	31	38	52	58	62	61	55	43	66
2 Break-Out	18	20	33	29	44	47	37	29	49
3 Inlet	34	43	60	60	58	58	52	41	65
3 Outlet	32	44	54	63	63	59	54	42	67
3 Break-Out	22	30	42	35	42	44	34	27	48
4 Inlet	27	32	48	55	57	59	56	43	63
4 Outlet	25	35	48	56	58	59	56	43	64
4 Break-Out	15	19	31	29	41	45	37	29	48
5 Inlet	26	30	47	51	56	57	52	40	61
5 Outlet	28	34	48	54	59	57	52	39	63
5 Break-Out	14	17	29	26	40	43	33	25	46
6 Inlet	30	39	56	56	54	55	49	37	62
6 Outlet	28	40	50	59	60	56	50	38	64
6 Break-Out	19	26	38	31	39	41	30	23	45
7 Inlet	22	26	43	49	52	54	50	38	58
7 Outlet	20	30	43	51	53	54	51	38	59
7 Break-Out	10	13	25	24	36	40	32	24	42
8 Inlet	21	25	42	46	51	52	47	34	56
8 Outlet	22	29	43	49	53	52	46	34	57
8 Break-Out	10	12	24	21	35	38	28	20	40
9 Inlet	25	34	51	51	49	49	44	32	56
9 Outlet	23	35	45	54	54	51	45	33	58
9 Break-Out	13	21	33	26	33	36	25	18	39
10 Inlet	14	19	36	42	44	47	43	31	50
10 Outlet	13	22	35	43	46	46	44	31	51
10 Break-Out	6	6	18	17	29	33	24	16	35
11 Inlet	13	17	34	38	43	45	39	27	48
11 Outlet	15	22	35	42	46	45	39	26	50
11 Break-Out	6	6	17	13	28	31	20	13	33
12 Inlet	18	27	43	44	42	42	36	25	49
12 Outlet	15	27	37	46	47	43	37	26	51
12 Break-Out	6	14	26	18	26	28	17	10	32

PERFORMANCE CURVES

- q_v : Airflow in m^3/h .
- p_{sf} : Static pressure in Pa.
- Dry air at 20°C and 760 mmHg.
- Performance data in accordance with ISO 5801 and AMCA 210-99 Standards.
- SFP: Specific fan power in $W/m^3/s$ (blue curves).

Air performance certified by AMCA is for installation type D – Ducted inlet, Ducted outlet.
 Performance ratings do not include the effects of appurtenances (accessories).

TD EVO-200 ECOWATT

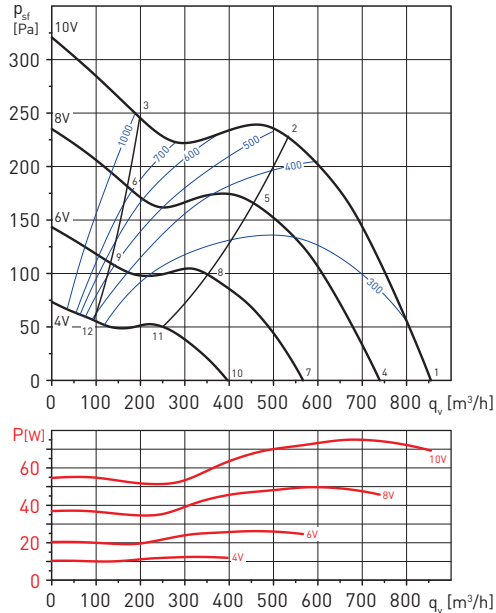

TD EVO-250 ECOWATT

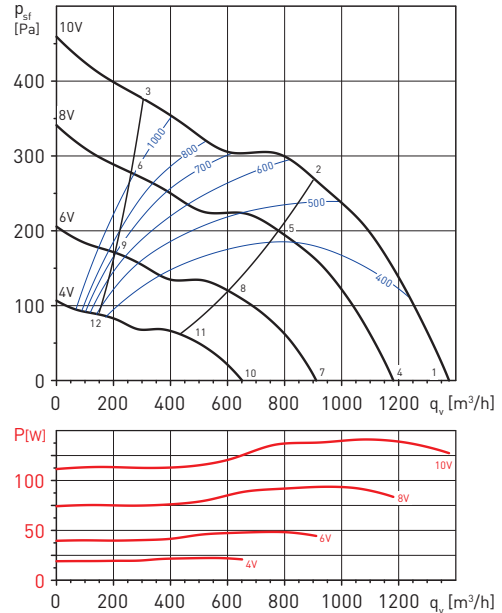

Sound data

Working point	1	2	3	4	5	6	7	8	9	10	11	12
LwiA	74	71	71	71	67	68	65	62	62	58	55	55

Sound performance certified by AMCA. Values shown are for inlet LwiA sound power levels for installation type D: ducted inlet, ducted outlet. Ratings include the effects of duct end correction.

The following sound data is a complementary data taken from S&P sound laboratory according ISO 13347-3, this data is not licensed by AMCA International.

Sound power spectrum (dB(A))

Working point	63	125	250	500	1000	2000	4000	8000	LwA	
1	Inlet	31	42	55	61	65	66	62	51	70
	Outlet	30	43	55	61	65	67	64	51	71
	Break-Out	12	25	42	43	50	50	38	26	54
2	Inlet	27	40	55	59	62	62	57	50	67
	Outlet	26	43	56	62	65	62	57	47	68
	Break-Out	9	23	41	41	47	46	33	25	51
3	Inlet	36	51	61	60	61	60	54	47	67
	Outlet	35	57	60	62	62	59	52	46	68
	Break-Out	17	34	48	42	47	44	29	23	52
4	Inlet	28	38	52	57	61	63	59	48	67
	Outlet	26	40	52	58	62	64	60	47	68
	Break-Out	9	21	39	39	47	47	34	23	51
5	Inlet	24	37	51	56	58	59	54	47	63
	Outlet	23	39	53	58	61	58	53	44	65
	Break-Out	5	20	38	38	44	42	29	22	47
6	Inlet	32	48	58	57	58	57	50	44	64
	Outlet	31	54	57	58	59	56	49	43	64
	Break-Out	13	31	45	39	44	41	26	19	49
7	Inlet	22	33	46	52	56	57	53	42	61
	Outlet	21	34	46	52	56	58	55	42	62
	Break-Out	8	16	33	34	42	41	29	18	45
8	Inlet	19	31	46	50	53	53	48	41	58
	Outlet	17	34	48	53	56	53	48	38	60
	Break-Out	8	14	33	32	38	37	24	17	42
9	Inlet	27	42	52	51	52	51	45	38	58
	Outlet	26	49	51	53	53	50	44	37	59
	Break-Out	8	25	39	33	38	35	20	14	43
10	Inlet	15	26	39	45	49	50	46	35	54
	Outlet	13	27	39	45	49	51	47	35	55
	Break-Out	8	9	26	27	34	34	22	10	38
11	Inlet	11	24	38	43	46	46	41	34	51
	Outlet	10	26	40	46	49	46	40	31	52
	Break-Out	8	10	25	25	31	29	17	10	35
12	Inlet	19	35	45	44	45	44	38	31	51
	Outlet	18	41	44	45	46	43	36	30	51
	Break-Out	8	18	32	26	31	28	13	10	36

Sound data

Working point	1	2	3	4	5	6	7	8	9	10	11	12
LwiA	79	75	76	75	72	73	70	66	68	63	59	61

Sound performance certified by AMCA. Values shown are for inlet LwiA sound power levels for installation type D: ducted inlet, ducted outlet. Ratings include the effects of duct end correction.

The following sound data is a complementary data taken from S&P sound laboratory according ISO 13347-3, this data is not licensed by AMCA International.

Sound power spectrum (dB(A))

Working point	63	125	250	500	1000	2000	4000	8000	LwA	
1	Inlet	31	48	60	65	72	71	67	60	76
	Outlet	36	49	61	65	73	72	68	59	76
	Break-Out	9	34	46	47	57	55	42	33	60
2	Inlet	35	46	59	62	68	67	61	54	72
	Outlet	37	45	60	63	70	68	61	53	73
	Break-Out	14	32	45	44	53	51	36	28	56
3	Inlet	42	58	64	66	69	68	62	56	73
	Outlet	43	56	65	66	69	67	60	53	73
	Break-Out	21	43	50	48	54	52	37	30	58
4	Inlet	28	45	57	62	68	68	63	56	72
	Outlet	32	46	58	61	69	69	64	56	73
	Break-Out	8	30	43	44	54	52	38	30	56
5	Inlet	32	42	55	58	64	64	58	51	69
	Outlet	34	42	56	60	67	65	58	49	70
	Break-Out	10	28	42	41	50	48	33	25	53
6	Inlet	39	54	61	62	66	64	59	52	70
	Outlet	40	53	62	62	65	63	56	49	70
	Break-Out	17	40	47	44	51	48	34	26	55
7	Inlet	22	39	51	56	63	62	58	51	67
	Outlet	27	41	52	56	64	63	59	50	68
	Break-Out	8	25	37	38	48	46	33	25	51
8	Inlet	27	37	50	53	59	59	52	46	63
	Outlet	29	36	51	55	61	59	53	44	64
	Break-Out	5	23	36	35	45	43	27	20	47
9	Inlet	34	49	55	57	60	59	53	47	65
	Outlet	34	48	56	57	60	58	51	44	64
	Break-Out	12	35	42	39	46	43	28	21	49
10	Inlet	15	32	44	49	56	55	51	44	60
	Outlet	20	33	45	49	57	56	52	43	61
	Break-Out	8	18	30	31	41	39	26	18	44
11	Inlet	19	30	43	46	52	51	45	39	56
	Outlet	21	29	44	47	54	52	45	37	57
	Break-Out	8	16	29	28	37	35	20	12	40
12	Inlet	27	42	48	50	53	52	46	40	58
	Outlet	27	41	49	50	53	51	44	37	57
	Break-Out	8	28	34	32	39	36	21	14	42

PERFORMANCE CURVES

- q_v : Airflow in m^3/h .
- p_{sf} : Static pressure in Pa.
- Dry air at 20°C and 760 mmHg.
- Performance data in accordance with ISO 5801 and AMCA 210-99 Standards.
- SFP: Specific fan power in $W/m^3/s$ (blue curves).

Air performance certified by AMCA is for installation type D – Ducted inlet, Ducted outlet.
Performance ratings do not include the effects of appurtenances (accessories).

TD EVO-315 ECOWATT

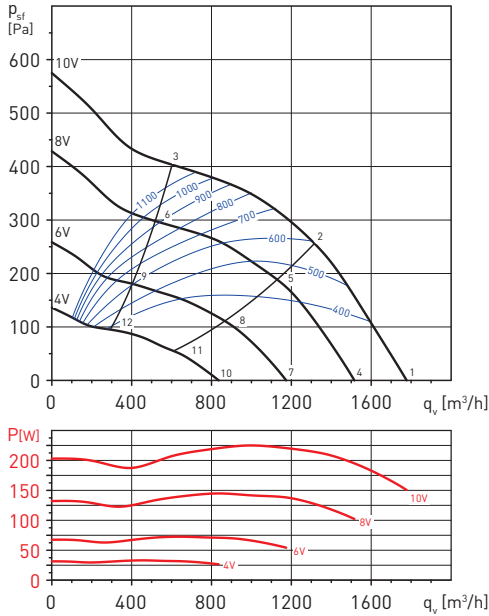

Sound data

Working point	1	2	3	4	5	6	7	8	9	10	11	12
LwiA	78	80	81	75	77	78	69	72	72	62	65	65

Sound performance certified by AMCA. Values shown are for inlet LwiA sound power levels for installation type D: ducted inlet, ducted outlet. Ratings include the effects of duct end correction.

The following sound data is a complementary data taken from S&P sound laboratory according ISO 13347-3, this data is not licensed by AMCA International.

Sound power spectrum (dB(A))

Working point		63	125	250	500	1000	2000	4000	8000	LwA
1	Inlet	34	52	62	66	70	70	68	58	75
	Outlet	59	63	63	68	72	70	68	57	77
	Break-Out	15	35	49	48	56	54	44	33	59
2	Inlet	35	67	67	71	72	71	66	59	77
	Outlet	34	52	64	68	71	70	63	58	75
	Break-Out	16	50	54	53	58	55	42	34	62
3	Inlet	46	61	71	73	72	70	65	58	78
	Outlet	49	64	70	71	71	72	63	58	77
	Break-Out	27	44	58	55	58	54	41	33	62
4	Inlet	31	49	59	63	67	67	65	55	72
	Outlet	56	60	59	65	69	67	65	54	73
	Break-Out	12	32	46	45	52	50	40	30	56
5	Inlet	32	64	64	68	69	68	63	56	74
	Outlet	31	49	61	65	68	67	60	54	72
	Break-Out	13	47	51	50	54	51	38	31	58
6	Inlet	43	58	68	70	69	67	62	55	75
	Outlet	45	60	67	67	68	68	60	54	74
	Break-Out	24	41	55	52	54	50	37	30	59
7	Inlet	25	43	53	57	61	61	59	49	66
	Outlet	50	54	54	59	64	62	59	48	68
	Break-Out	10	26	40	39	47	45	35	25	50
8	Inlet	26	58	58	62	63	62	57	50	69
	Outlet	25	43	56	59	62	61	54	49	67
	Break-Out	10	41	45	44	49	46	33	26	53
9	Inlet	37	52	62	64	63	61	56	49	69
	Outlet	40	55	61	62	63	63	54	49	69
	Break-Out	18	35	49	46	49	45	32	25	54
10	Inlet	18	36	46	50	54	54	52	42	59
	Outlet	43	47	47	52	57	55	52	41	61
	Break-Out	10	19	33	32	40	38	28	18	43
11	Inlet	19	51	51	55	56	55	50	43	62
	Outlet	18	36	49	52	55	54	47	42	60
	Break-Out	10	34	38	37	42	39	26	19	46
12	Inlet	30	45	55	57	56	54	49	42	62
	Outlet	33	48	54	55	56	56	47	42	62
	Break-Out	11	28	42	39	42	38	25	18	47

GENERAL INSTALLATION ACCESSORIES

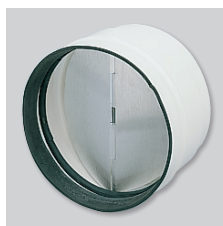

MCA

Back-draft shutters mounted at the outlet of the fans, to prevent external air entry and to limit heat leakage, when the fan are not in use.

Model	Type of TD EVO
MCA-250	TD EVO 100
MCA-350	TD EVO 125
MCA-500/150 S	TD EVO 150
MCA-500/160 S	TD EVO 160
MCA-800	TD EVO 200
MCA-1000	TD EVO 250
MCA-2000	TD EVO 315

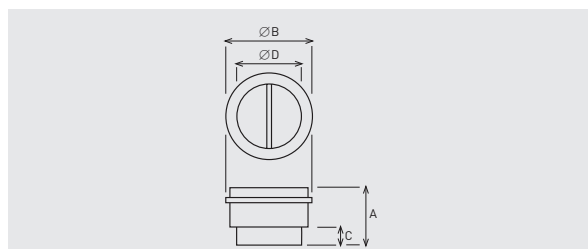

Model	A	Ø B	C	Ø D
MCA-250	107	109	31,5	94,5
MCA-350	107	136	31,5	119,5
MCA-500/150 S	121	163,5	35	147
MCA-500/160 S	121	173,5	35	157
MCA-800	131,5	214	35	197,5
MCA-1000	164	264,5	42	248
MCA-2000	205	330	50	312



MAR

Rectangular duct adapters enable TD EVO to be connected to rectangular ducting.

Model	Type of TD EVO	Nominal dim. of ducting LxH
MAR-250	TD EVO 100	224x140
MAR-250-350 S	TD EVO 125	224x140
MAR-500 S	TD EVO 150	280x180
MAR-500/160	TD EVO 160	280x180
MAR-800-1000 S	TD EVO 200	315x200
MAR-1000	TD EVO 250	400x250
MAR-2000	TD EVO 315	500x315

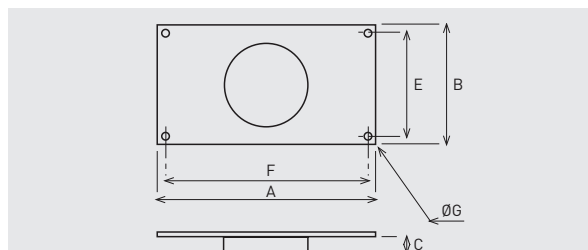

Model	A	B	C	E	F	Ø G
MAR-250	264	180	33,3	160	244	9
MAR-250-350 S	264	180	33,5	160	244	9
MAR-500 S	320	220	37	200	300	9
MAR-500/160	320	220	37	200	300	9
MAR-800-1000 S	355	240	37	220	335	9
MAR-1000	440	290	42	270	420	9
MAR-2000	540	355	52	355	520	9



MRJ

Grilles mounted at the inlet or outlet of the fan, to prevent the entry of any foreign objects that could damage the fan.

Model	Type of TD EVO
MRJ-250	TD EVO 100
MRJ-250-350 S	TD EVO 125
MRJ-500 S	TD EVO 150
MRJ-500/160	TD EVO 160
MRJ-800-1000 S	TD EVO 200
MRJ-1000	TD EVO 250
MRJ-2000	TD EVO 315



MFL-G4

Filtration box with G4 grade filter included.

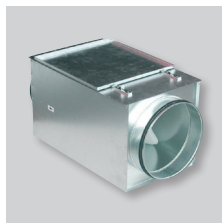

MFL-F

Box in galvanized sheet steel to incorporate filters MFR F5, F6 or F7.



MBE

Electric heater attenuators.



SIL

Circular sound attenuators.



GSA-M0

Flexible aluminium ducting.



GSI-M0

Flexible acoustic ducting.

GENERAL INSTALLATION ACCESSORIES

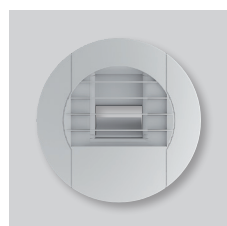

BEH
Circular air valves.



EC AIR ENTRY
Reducer.



BOC
Circular air valves.



PER-W
Outdoor plastic louvre shutters.

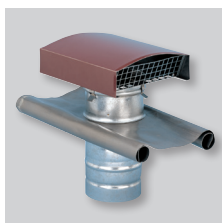

CT
Roof terminal kits.



GRA
Aluminium external grilles.



GRI
Internal extract grilles.

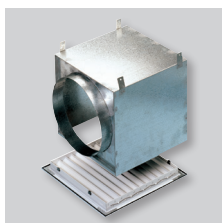

RP
Terminal connectors for GRI internal grilles.



GCI
Interior circular grilles.

ELECTRICAL ACCESSORIES



REB-ECOWATT
Remote speed control.



AIRSENS
Single-phase speed controller.



AIRSENS RF REC
Smart probe and wireless receiver by radio frequency.



AIRSENS WIFI
Remote monitoring through CONNECTAIR platform.



CONTROL ECOWATT AC/DC
Control element for demand controlled ventilation systems.



TDP-S/TDP-D/TDP-PI
Pressure sensor.



CONTROL ECOWATT BASIC
Speed control and single-phase ON/OFF.



CPTA-S/CPTA-E
Presence detector.



REMP
Motorised damper.