



Plate mounted axial flow fans with impeller manufactured from plastic and dynamically balanced, low sound level, protected against corrosion by polyester black paint finish.

Motors

Brushless EC motor with high performance and low consumption, supply 230V±10% 50/60Hz, IP44, ball bearings and thermal protection included. Speed adjustable 100% via potentiometer located in the terminal box or via external control REB-ECOWATT type. Analogue input remote control with a 0-10V external signal. Working temperature from -20°C to +40°C.

Additional information

Air direction: form (A) configuration (motor over impeller).



Compact design

This very low profile design optimises airflow performances whilst minimising noise generation.



Corrosion resistance

Mounting plate, motor support and finger proof guard protected by cataforesis primer and black polyester paint finish. Stainless steel screws.



Terminal box IP65



**High efficiency
"AMAX" impeller**

Designed to ensure the highest and most efficient airflow performance with the lowest noise level. Manufactured from polyamide reinforced plastic.

TECHNICAL CHARACTERISTICS

Before installation check that the product electrical characteristics listed on the data plate label (voltage, power, frequency, etc.) match those of the intended electrical supply.

Model	Control Voltage (V)	Speed (r.p.m.)	Maximum absorbed power (W)	Maximum absorbed current (A)	Maximum airflow (m ³ /h)	Sound pressure level* (dB(A))	Weight (kg)
HXBR-200 ECOWATT	10	2800	103	0,7	1.335	57	4
	8	2680	91	0,7	1.292	56	
	6	2110	46	0,3	1.025	50	
	4	1525	19	0,2	705	43	
HXBR-250 ECOWATT	10	2270	118	0,8	2.070	60	4,5
	8	1910	70	0,5	1.710	56	
	6	1520	37	0,3	1.360	51	
	4	1140	17	0,1	1.015	45	
HXBR-300 ECOWATT	10	1749	164	1,1	2.835	57	6
	8	1605	128	0,9	2.620	55	
	6	1325	74	0,5	2.155	49	
	4	1040	39	0,3	1.670	43	
HXBR-315 ECOWATT	10	1675	167	1,1	3.015	57	6
	8	1505	121	0,8	2.695	55	
	6	1190	63	0,4	2.160	50	
	4	885	29	0,2	1.590	42	
HXBR-355 ECOWATT	10	1550	184	1,2	3.640	60	8
	8	1420	141	0,9	3.330	58	
	6	1195	84	0,6	2.785	54	
	4	960	46	0,3	2.230	49	
HXBR-400 ECOWATT	10	1450	375	1,6	5.730	61	8,5
	8	1270	256	1,1	5.025	58	
	6	1035	144	0,6	4.140	53	
	4	784	70	0,3	3.095	48	
HXBR-450 ECOWATT	10	1250	352	1,5	6.440	61	9
	8	1120	254	1,1	5.780	58	
	6	920	146	0,6	4.740	53	
	4	725	77	0,4	3.760	48	

* Sound pressure level measured in free field conditions at a distance equivalent to three times the diameter of the impeller with a minimum of 1,5 meters.

DIMENSIONS (mm)

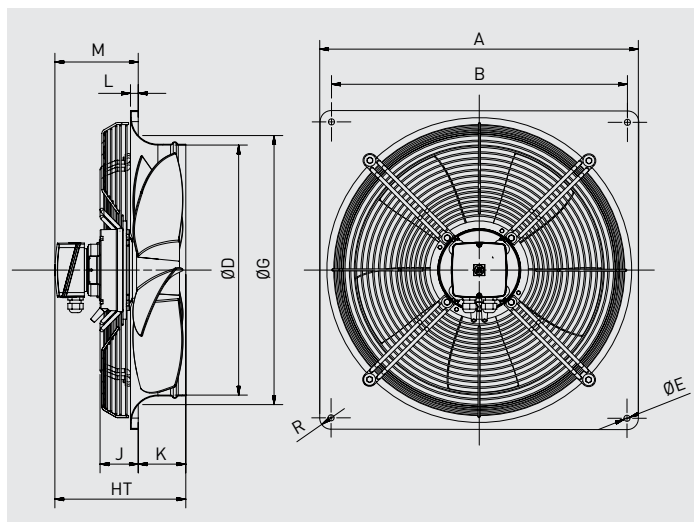

Model	A	B	D	E	G	HT	J	K	L	M	R
200	312	260	200	7	210	190	70	46	6	138	20
250	370	320	254	7	264	190	70	48	6	136	20
300	430	380	305	9	324	190	55	71	11	108	20
315	430	380	317	9	330	190	55	71	11	108	20
355	485	435	358	9	378	190	56	74	12	104	20
400	540	490	403	9	426	232	62	88	12	132	20
450	576	535	452	11	487	237	69	86	14	137	20

PERFORMANCE CURVES

- q_v : Airflow in m³/h and m³/s.
- p_{sf} : Static pressure in Pa.
- SFP: Specific fan power in W/m³/s.
- P: Input power in W.
- Measurement category: A.
- Efficiency category: static.
- Fan efficiency without speed control.
- Fan tested without protection guard.
- Airflow data in accordance with ISO 5801.
- Sound pressure level dB(A), measured in a free field distance equal to 3 times the diameter, with a minimum of 1,5 m.

- MC** Measurement category
- EC** Efficiency category
- VSD** Speed control: supplied with the fan.
- SR** Specific ratio
- η [%]** Efficiency
- N** Efficiency grade
- [kW]** Absorbed power
- [m³/h]** Airflow
- [Pa]** Static pressure
- [RPM]** Speed

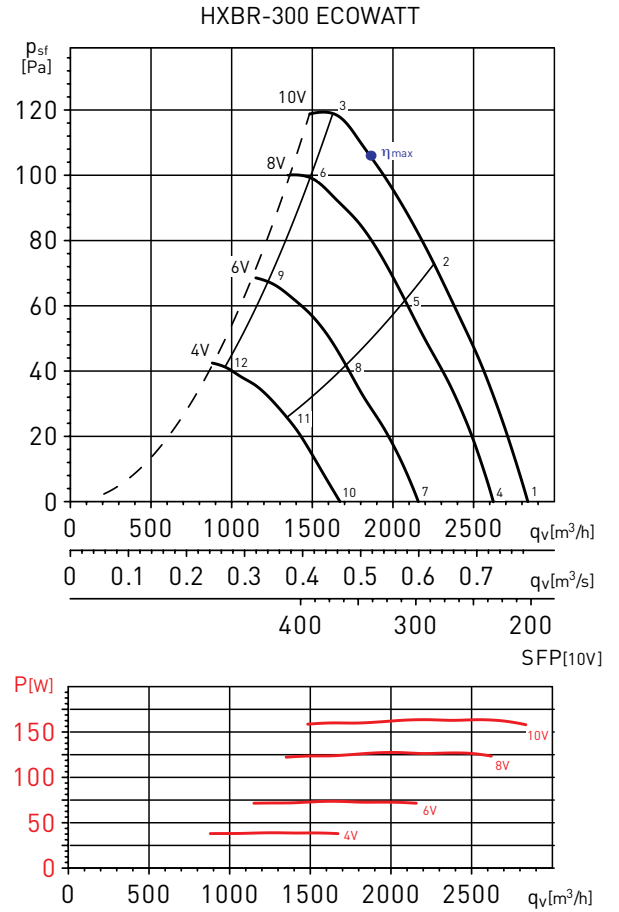

MC	EC	VSD	SR	η [%]	N	[kW]	[m ³ /h]	[Pa]	[RPM]
A	Static	Sí	1	39,4	50,8	0,159	1.768	112	1748

PERFORMANCE CURVES

- q_v : Airflow in m^3/h .
- p_{sf} : Static pressure in Pa.
- SFP: Specific fan power in $W/m^3/s$.
- Dry air at $20^\circ C$ and 760 mmHg .
- Performance data in accordance with ISO 5801 and AMCA 210-99 Standards.

HXBR-200 ECOWATT

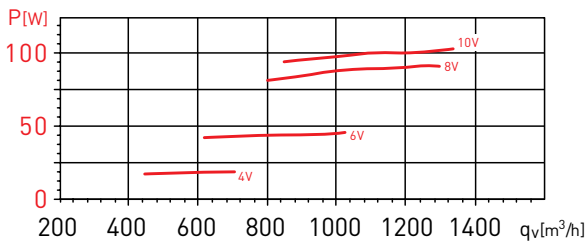
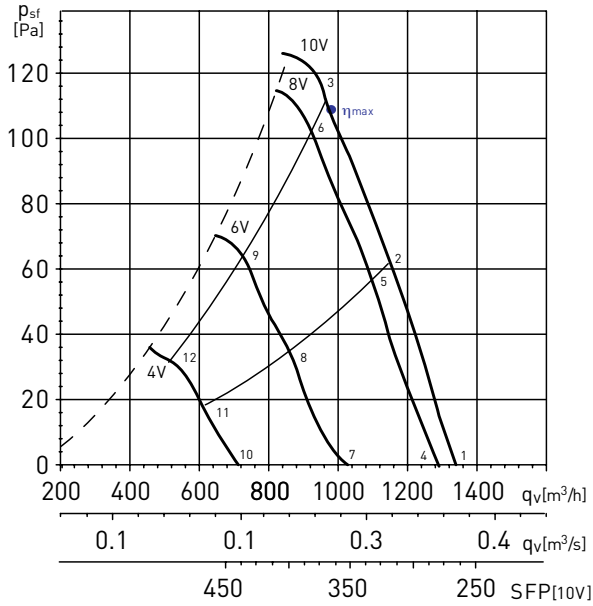

Sound power level spectrums in dB(A)

Working point		63	125	250	500	1.000	2.000	4.000	8.000	LwA
1	Inlet	43	50	61	61	69	69	66	61	74
	Outlet	43	50	66	66	70	69	65	61	75
2	Inlet	44	48	60	60	66	66	63	58	71
	Outlet	41	49	63	65	68	66	63	58	73
3	Inlet	48	54	62	63	66	66	63	56	71
	Outlet	43	53	64	66	68	66	63	57	73
4	Inlet	41	49	59	60	67	68	65	60	72
	Outlet	42	49	64	65	68	68	64	59	73
5	Inlet	41	48	58	59	64	65	62	56	70
	Outlet	40	49	61	64	67	65	62	56	71
6	Inlet	44	52	60	61	64	65	62	56	70
	Outlet	42	52	61	65	66	65	61	56	71
7	Inlet	35	49	52	56	60	63	60	53	67
	Outlet	37	53	55	59	62	62	59	52	67
8	Inlet	36	47	50	54	57	61	57	49	64
	Outlet	37	50	53	58	60	60	56	49	65
9	Inlet	36	49	52	55	57	59	55	48	64
	Outlet	38	50	54	58	59	59	55	48	65
10	Inlet	30	42	43	49	53	57	51	40	60
	Outlet	30	44	46	52	54	54	50	39	59
11	Inlet	30	41	42	48	50	55	48	38	57
	Outlet	32	43	45	50	52	53	47	37	57
12	Inlet	31	40	44	47	50	53	46	36	56
	Outlet	32	42	46	50	51	52	46	36	57

PERFORMANCE CURVES

- q_v : Airflow in m^3/h .
- p_{st} : Static pressure in Pa.
- SFP: Specific fan power in $W/m^3/s$.
- Dry air at $20^\circ C$ and 760 mmHg .
- Performance data in accordance with ISO 5801 and AMCA 210-99 Standards.

HXBR-250 ECOWATT

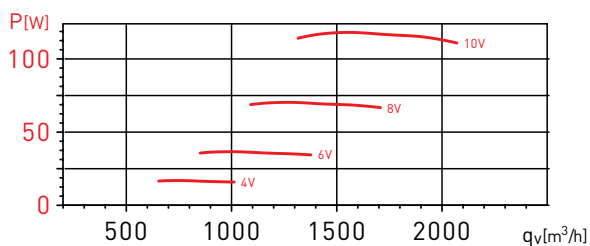
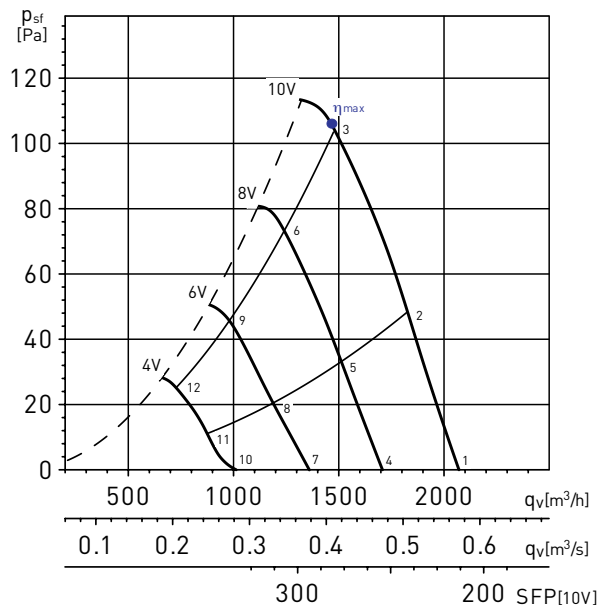

Sound power level spectrums in dB(A)

Working point		63	125	250	500	1.000	2.000	4.000	8.000	LwA
1	Inlet	39	52	59	67	69	70	67	59	75
	Outlet	48	54	60	68	70	69	66	59	75
2	Inlet	40	51	59	64	69	69	66	58	74
	Outlet	44	52	59	65	69	68	65	58	74
3	Inlet	42	55	60	64	68	67	63	56	72
	Outlet	43	52	59	64	68	66	61	55	72
4	Inlet	36	51	54	63	65	66	63	54	71
	Outlet	43	51	56	63	65	65	62	53	70
5	Inlet	37	50	54	61	65	66	62	53	70
	Outlet	39	52	56	62	65	64	61	53	70
6	Inlet	38	52	55	59	63	63	58	50	68
	Outlet	38	51	55	60	63	61	56	49	67
7	Inlet	34	45	52	57	59	62	56	45	65
	Outlet	36	46	52	57	59	59	55	45	64
8	Inlet	34	46	51	56	59	62	56	45	65
	Outlet	35	48	50	56	59	59	55	45	64
9	Inlet	36	48	51	55	58	60	52	43	64
	Outlet	37	46	51	55	57	56	50	41	61
10	Inlet	31	39	50	51	56	58	47	34	61
	Outlet	32	41	46	50	52	52	46	33	57
11	Inlet	31	38	48	50	54	56	46	32	59
	Outlet	32	40	44	49	52	51	45	32	56
12	Inlet	36	43	49	50	54	56	44	32	60
	Outlet	34	39	45	48	50	48	41	29	54

PERFORMANCE CURVES

- q_v : Airflow in m^3/h .
- p_{sf} : Static pressure in Pa.
- SFP: Specific fan power in $W/m^3/s$.
- Dry air at 20°C and 760 mmHg.
- Performance data in accordance with ISO 5801 and AMCA 210-99 Standards.

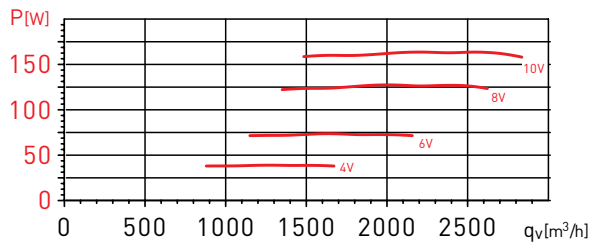
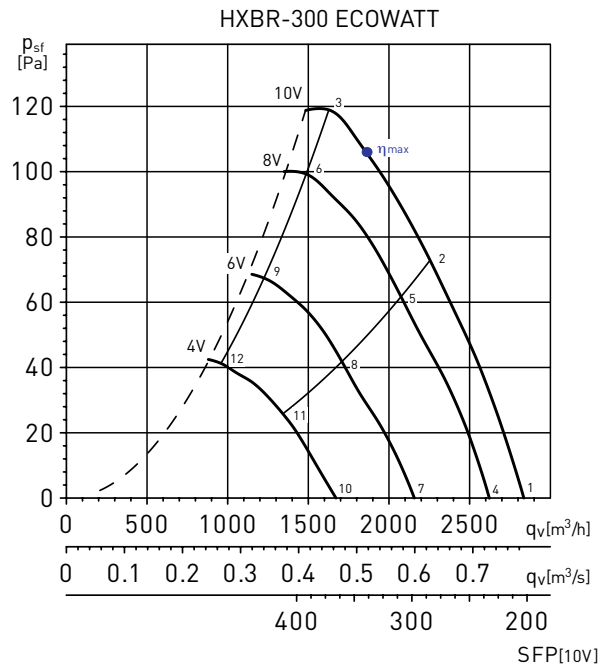

Sound power level spectrums in dB(A)

Working point		63	125	250	500	1.000	2.000	4.000	8.000	LwA
1	Inlet	36	56	56	66	69	70	66	56	75
	Outlet	47	61	60	69	69	69	67	58	75
2	Inlet	42	54	53	62	65	64	62	54	70
	Outlet	42	59	58	65	66	64	62	55	71
3	Inlet	54	57	61	65	67	67	63	54	72
	Outlet	50	58	60	65	67	65	62	54	72
4	Inlet	35	52	54	64	67	68	64	53	72
	Outlet	48	57	57	67	68	68	65	55	73
5	Inlet	40	51	51	60	63	63	60	51	68
	Outlet	40	55	55	63	63	62	60	53	69
6	Inlet	49	53	55	60	63	63	59	51	68
	Outlet	49	55	58	63	65	64	60	52	70
7	Inlet	33	45	53	59	63	64	59	46	68
	Outlet	41	50	55	61	63	64	59	48	68
8	Inlet	36	43	49	54	58	59	55	44	63
	Outlet	36	48	52	56	57	58	54	45	63
9	Inlet	44	47	50	54	57	57	53	44	62
	Outlet	44	49	53	57	59	58	54	45	64
10	Inlet	33	39	48	53	57	58	51	36	62
	Outlet	38	41	51	54	57	58	51	38	62
11	Inlet	32	37	43	47	51	52	46	32	56
	Outlet	37	40	46	49	51	52	46	34	57
12	Inlet	37	41	45	48	52	52	45	33	56
	Outlet	38	43	48	50	53	53	46	34	58

MC	EC	VSD	SR	η [%]	N	[kW]	[m^3/h]	[Pa]	[RPM]
A	Static	Sí	1	39,4	50,8	0,159	1768	112	1748

PERFORMANCE CURVES

- q_v : Airflow in m^3/h .
- p_{st} : Static pressure in Pa.
- SFP: Specific fan power in $W/m^3/s$.
- Dry air at 20°C and 760 mmHg.
- Performance data in accordance with ISO 5801 and AMCA 210-99 Standards.

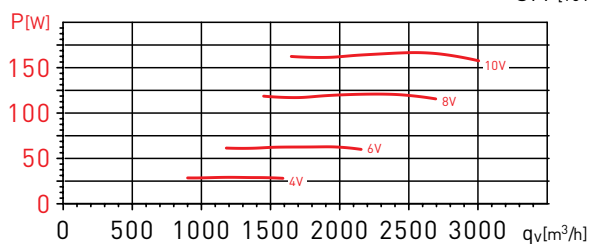
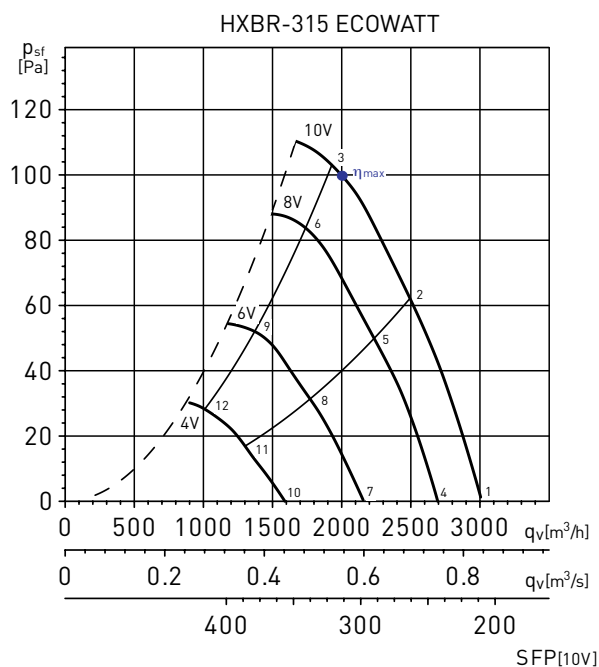

Sound power level spectrums in dB(A)

Working point		63	125	250	500	1.000	2.000	4.000	8.000	LwA
1	Inlet	39	61	58	66	69	69	65	55	74
	Outlet	48	63	59	67	68	68	65	56	74
2	Inlet	40	57	58	64	66	66	62	54	71
	Outlet	42	58	61	65	66	65	61	53	71
3	Inlet	49	58	62	65	67	66	61	53	72
	Outlet	48	60	62	66	67	65	60	53	72
4	Inlet	39	59	55	62	65	66	62	51	71
	Outlet	45	61	58	64	66	66	62	52	71
5	Inlet	40	55	55	62	63	63	60	50	69
	Outlet	40	57	58	63	63	62	58	50	69
6	Inlet	47	55	58	63	64	63	58	49	69
	Outlet	46	57	59	63	64	62	57	49	69
7	Inlet	38	52	55	57	61	62	56	44	66
	Outlet	38	52	54	58	60	61	55	44	66
8	Inlet	38	49	52	57	58	59	54	42	64
	Outlet	37	49	53	56	57	57	52	41	63
9	Inlet	41	49	53	56	57	57	51	41	62
	Outlet	41	51	54	56	57	56	50	40	62
10	Inlet	43	40	47	48	53	53	44	30	57
	Outlet	44	41	47	49	53	53	44	31	57
11	Inlet	38	42	46	46	51	52	43	30	56
	Outlet	39	42	46	48	50	51	42	29	55
12	Inlet	38	42	45	46	49	48	40	29	54
	Outlet	40	43	46	47	49	48	40	28	54

MC	EC	VSD	SR	η [%]	N	[kW]	[m³/h]	[Pa]	[RPM]
A	Static	Si	1	39,2	50,5	0,162	1.984	101	1673

PERFORMANCE CURVES

- q_v : Airflow in m^3/h .
- p_{sf} : Static pressure in Pa.
- SFP: Specific fan power in $W/m^3/s$.
- Dry air at $20^\circ C$ and 760 mmHg .
- Performance data in accordance with ISO 5801 and AMCA 210-99 Standards.

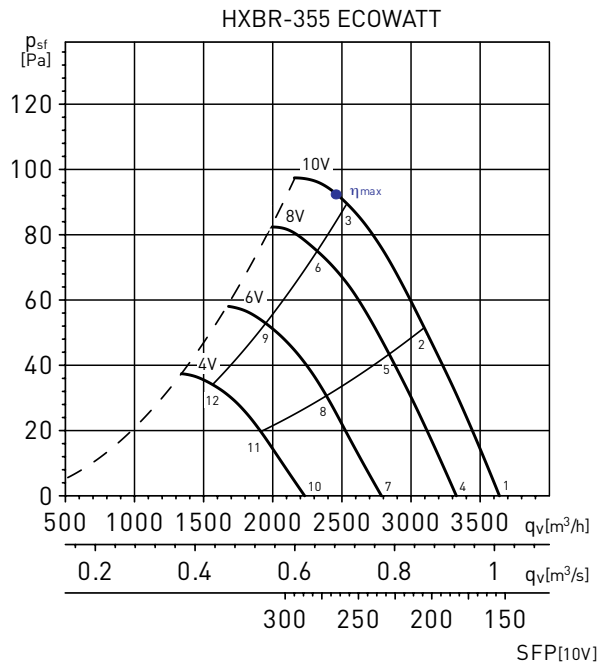

Sound power level spectrums in dB(A)

Working point		63	125	250	500	1.000	2.000	4.000	8.000	LwA
1	Inlet	41	63	61	68	71	72	68	58	77
	Outlet	56	60	61	70	72	71	68	60	77
2	Inlet	42	60	59	65	68	69	66	57	74
	Outlet	45	57	59	67	70	69	67	59	75
3	Inlet	45	60	61	64	66	68	65	56	73
	Outlet	44	56	60	64	66	67	66	58	72
4	Inlet	40	60	61	67	69	70	66	55	75
	Outlet	54	57	59	67	70	69	66	57	75
5	Inlet	41	58	59	63	66	68	65	55	72
	Outlet	50	58	64	65	67	67	63	54	73
6	Inlet	45	57	60	62	65	67	63	54	71
	Outlet	46	55	60	63	65	66	63	55	71
7	Inlet	40	55	58	62	65	66	61	49	70
	Outlet	46	51	57	63	65	65	61	50	70
8	Inlet	42	53	55	59	62	64	60	48	68
	Outlet	43	50	55	62	63	64	61	50	69
9	Inlet	39	53	56	56	60	63	58	48	67
	Outlet	41	48	55	58	61	63	59	49	67
10	Inlet	49	46	53	56	59	61	54	41	65
	Outlet	44	43	53	56	59	60	54	42	64
11	Inlet	47	44	49	54	58	60	52	39	63
	Outlet	44	44	53	56	58	59	54	42	64
12	Inlet	47	43	48	50	56	58	50	38	61
	Outlet	42	44	49	52	55	58	52	40	61

MC	EC	VSD	SR	η [%]	N	[kW]	[m^3/h]	[Pa]	[RPM]
A	Static	Sí	1	39,4	50,4	0,182	2.457	93	1549

PERFORMANCE CURVES

- q_v : Airflow in m^3/h .
- p_{sf} : Static pressure in Pa.
- SFP: Specific fan power in $W/m^3/s$.
- Dry air at $20^\circ C$ and 760 mmHg .
- Performance data in accordance with ISO 5801 and AMCA 210-99 Standards.

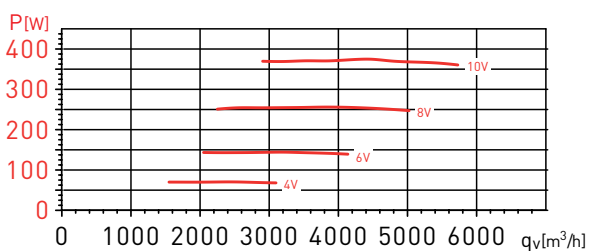
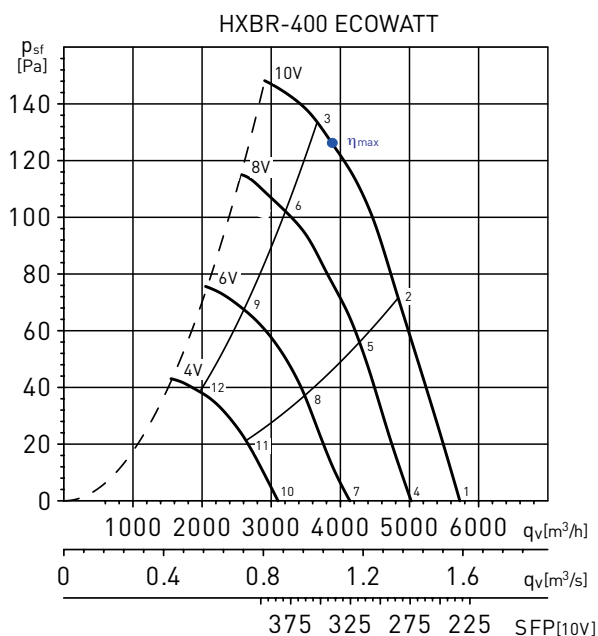

MC	EC	VSD	SR	η [%]	N	[kW]	[m³/h]	[Pa]	[RPM]
A	Static	Si	1	41	50,1	0,37	3.771	130	1449

Sound power level spectrums in dB(A)

Working point		63	125	250	500	1.000	2.000	4.000	8.000	LwA
1	Inlet	46	57	60	68	73	71	67	59	76
	Outlet	65	65	65	71	72	70	67	60	77
2	Inlet	42	55	59	66	71	70	67	59	75
	Outlet	54	58	63	69	71	69	67	59	75
3	Inlet	53	55	61	64	68	68	65	59	73
	Outlet	55	58	65	68	70	68	66	59	75
4	Inlet	43	54	58	65	69	68	63	55	73
	Outlet	59	61	63	67	69	67	63	56	74
5	Inlet	40	52	56	63	67	67	63	54	72
	Outlet	48	54	61	65	67	66	63	55	72
6	Inlet	50	52	57	61	65	66	62	55	70
	Outlet	49	54	61	64	66	66	63	55	72
7	Inlet	49	48	54	60	64	63	58	48	68
	Outlet	54	54	58	61	64	62	58	48	69
8	Inlet	44	45	51	58	62	62	58	47	67
	Outlet	45	49	56	59	63	62	58	48	67
9	Inlet	46	49	53	57	61	61	57	47	66
	Outlet	43	49	56	58	62	62	58	48	67
10	Inlet	37	41	55	54	58	56	49	38	62
	Outlet	44	45	54	55	58	56	49	39	62
11	Inlet	35	39	55	52	57	56	49	38	62
	Outlet	38	41	52	53	57	56	50	38	61
12	Inlet	36	41	55	52	56	55	49	38	61
	Outlet	38	44	52	53	58	56	49	38	61

PERFORMANCE CURVES

- q_v : Airflow in m^3/h .
- p_{sf} : Static pressure in Pa.
- SFP: Specific fan power in $W/m^3/s$.
- Dry air at $20^\circ C$ and 760 mmHg .
- Performance data in accordance with ISO 5801 and AMCA 210-99 Standards.

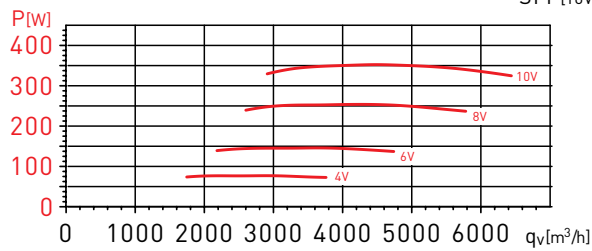
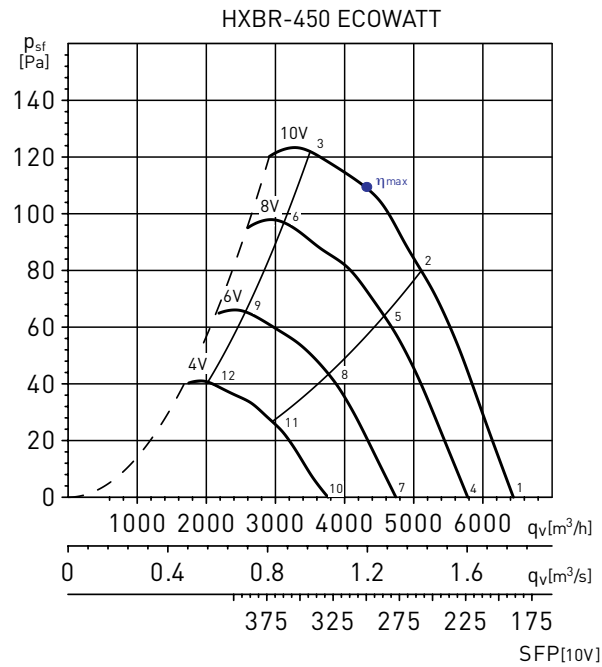

Sound power level spectrums in dB(A)

Working point		63	125	250	500	1.000	2.000	4.000	8.000	LwA
1	Inlet	46	57	60	68	73	71	67	59	76
	Outlet	65	65	65	71	72	70	67	60	77
2	Inlet	42	55	59	66	71	70	67	59	75
	Outlet	54	58	63	69	71	69	67	59	75
3	Inlet	53	55	61	64	68	68	65	59	73
	Outlet	55	58	65	68	70	68	66	59	75
4	Inlet	43	54	58	65	69	68	63	55	73
	Outlet	59	61	63	67	69	67	63	56	74
5	Inlet	40	52	56	63	67	67	63	54	72
	Outlet	48	54	61	65	67	66	63	55	72
6	Inlet	50	52	57	61	65	66	62	55	70
	Outlet	49	54	61	64	66	66	63	55	72
7	Inlet	49	48	54	60	64	63	58	48	68
	Outlet	54	54	58	61	64	62	58	48	69
8	Inlet	44	45	51	58	62	62	58	47	67
	Outlet	45	49	56	59	63	62	58	48	67
9	Inlet	46	49	53	57	61	61	57	47	66
	Outlet	43	49	56	58	62	62	58	48	67
10	Inlet	37	41	55	54	58	56	49	38	62
	Outlet	44	45	54	55	58	56	49	39	62
11	Inlet	35	39	55	52	57	56	49	38	62
	Outlet	38	41	52	53	57	56	50	38	61
12	Inlet	36	41	55	52	56	55	49	38	61
	Outlet	38	44	52	53	58	56	49	38	61

MC	EC	VSD	SR	η [%]	N	[kW]	[m^3/h]	[Pa]	[RPM]
A	Static	Sí	1	41,9	51,1	0,352	4.370	108	1249

MOUNTING ACCESSORIES

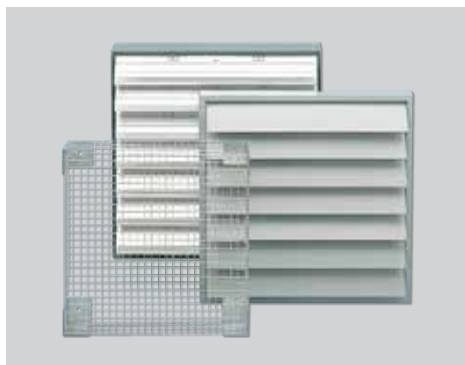

Model	Protection wires	Louvre back draft shutters	
		Plastic	Aluminium
200	DEF-250 D	PER-200 W	PER-250 CR
250	DEF-250 D	PER-250 W	PER-250 CR
300	DEF-325 D	PER-355 W	PER-250 CR
315	DEF-325 D	PER-355 W	PER-355 CR
355	DEF-375 D	PER-355 W	PER-355 CR
400	DEF-450 D	PER-400 W	PER-400 CR
450	DEF-450 D	PER-450 W	PER-450 CR

ELECTRICAL ACCESSORIES



REB-ECOWATT
Remote speed control.



CONTROL ECOWATT BASIC
Speed control and single-phase ON/OFF.



CONTROL ECOWATT
Control element with functions COP/ VAV/ MIN-MAX.



CPFL
Presence detector.



SC02-A
CO₂ and temperature sensor.
SC02-AD
CO₂ and temperature sensor, with display.
SCHT-AD
CO₂ sensor, temperature and relative humidity with display.



TDP-S
Pressure sensor without display.
TDP-D
Pressure sensor with display.
TDP-PI
Pressure sensor with display.